

DIN-Power F032FL-9,0C1-3



Image is for illustration purposes only. Please refer to product description.

Part number	09 06 232 7843
Specification	DIN-Power F032FL-9,0C1-3
HARTING eCatalogue	https://b2b.harting.com/09062327843

Identification

Category	Connectors
Series	DIN 41612
Identification	Type F
Element	Female connector
Description of the contact	Straight
Features	lead-free

Version

Termination method	Solder lug termination
Connection type	PCB to cable
Number of contacts	32
Contact configuration	Rows z and d, positions 2, 4, ... , 30, 32
Coding	Hole coding Coding with loss of contacts
PCB fixing	With fixing flange

Technical characteristics

Contact rows	3
Contact spacing (mating side)	3.81 mm 5.08 mm
Rated current	6 A
Rated current	Rated current measured at 20 °C, see derating curve for details
Clearance distance	≥1.6 mm
Creepage distance	≥3 mm



Pushing Performance
 Since 1945

Technical characteristics

Insulation resistance	$>10^{12} \Omega$
Contact resistance	$\leq 15 \text{ m}\Omega$
Limiting temperature	-55 ... +125 °C
Insertion and withdrawal force	$\leq 50 \text{ N}$
Performance level	3 acc. to IEC 60603-2
Mating cycles	≥ 50
Test voltage $U_{r.m.s.}$	1.55 kV (contact-contact) 2.5 kV (contact-ground)
Isolation group	IIIa ($175 \leq \text{CTI} < 400$)
Hot plugging	No

Material properties

Material (insert)	Thermoplastic resin, glass-fibre filled
Colour (insert)	RAL 7032 (pebble grey)
Material (contacts)	Copper alloy
Surface (contacts)	Noble metal over Ni Mating side Sn over Ni Termination side
Material flammability class acc. to UL 94	V-0
RoHS	compliant
ELV status	compliant
China RoHS	e
REACH Annex XVII substances	Not contained
REACH ANNEX XIV substances	Not contained
REACH SVHC substances	Not contained
California Proposition 65 substances	Yes
California Proposition 65 substances	Antimony trioxide Nickel
Fire protection on railway vehicles	EN 45545-2 (2020-08)
Requirement set with Hazard Levels	R26

Specifications and approvals

Specifications	IEC 60603-2
UL / CSA	UL 1977 ECBT2.E102079 CSA-C22.2 No. 182.3 ECBT8.E102079



Pushing Performance
Since 1945

Specifications and approvals

Railway classification	F4/I3 acc. to NFF 16-101/102
------------------------	------------------------------

Commercial data

Packaging size	20
Net weight	31.28 g
Country of origin	Germany
European customs tariff number	85366990
GTIN	5713140013483
eCl@ss	27460201 PCB connector (board connector)

Current carrying capacity

The current carrying capacity of the connectors is limited by the thermal load capability of the contact element material including the connections and the insulating parts. The derating curve is therefore valid for currents which flow constantly (non-intermittent) through each contact element of the connector evenly, without exceeding the allowed maximum temperature.
Measuring and testing techniques acc. to IEC 60512-5-2

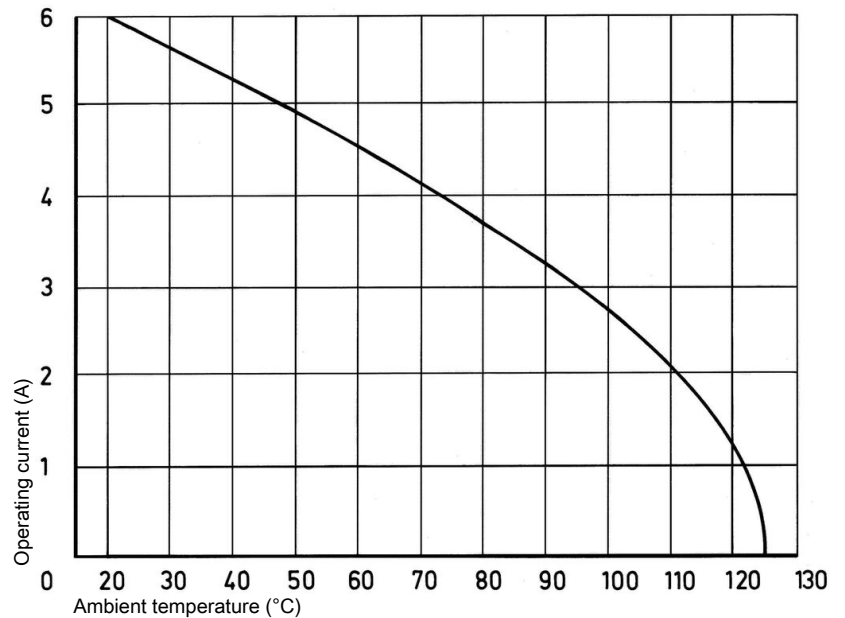

Hole coding (without loss of contact)

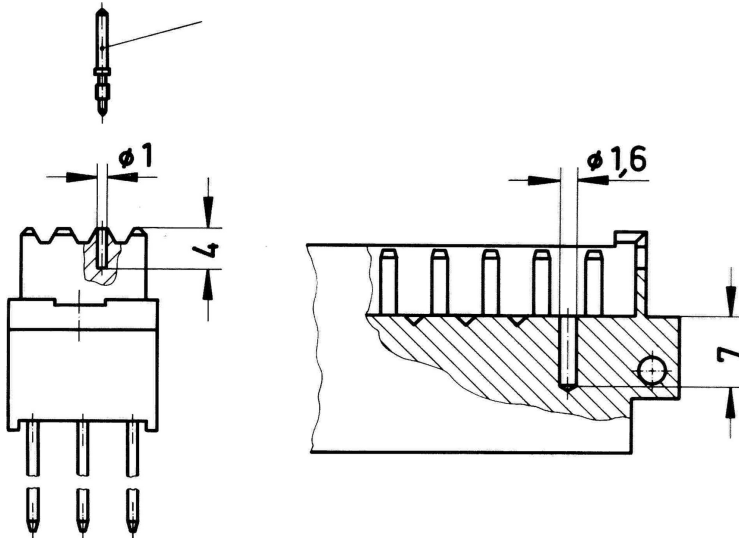

To avoid cross-plugging of adjacent connectors a coding system is required.
Drill out the male connector at pre-centered point according to the sketch. Use the setting tool 09 99 000 0103 to insert the coding pin 09 06 000 9950 into the existing hole in the female connector.

Coding with loss of contacts

To avoid cross-plugging of adjacent connectors a coding system is required.

The coding is achieved by means of a code pin which is inserted into the selected chamber of the female connector (the contact cavity must be filled with a female contact!).

The opposite male contact must be removed with the help of the specially designed tool. It's recommended to use at least 3 pins.

Coding pin 09 04 000 9908

Removal tool for male contacts 09 99 000 0038

Mating conditions

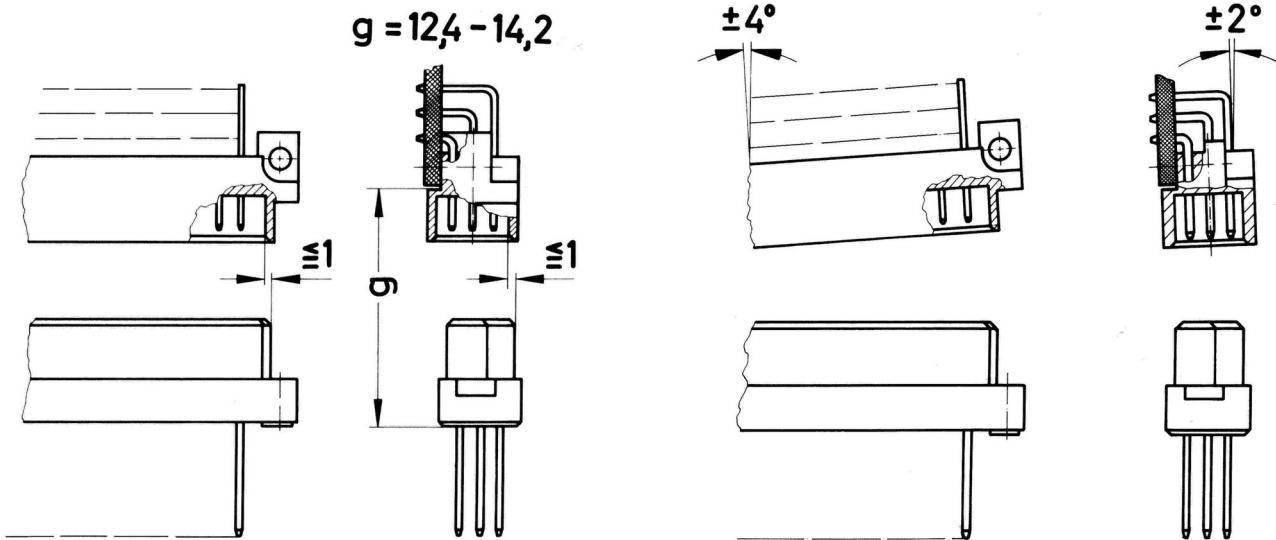

To ensure reliable connections and prevent unnecessary damage, please refer to the application data diagrams. These recommendations are set out in IEC 60603-2. The connectors should not be coupled and decoupled under electrical load.