



Relays & Contactors > Relay Accessories



Relay Accessory Type: **Accessory, Retaining Clip**

Features

Product Type Features

Relay Accessory Type	Accessory, Retaining Clip
----------------------	---------------------------

Product Compliance

[For compliance documentation, visit the product page on TE.com>](#)

EU RoHS Directive 2011/65/EU	Compliant
EU ELV Directive 2000/53/EC	Compliant
China RoHS 2 Directive MIIT Order No 32, 2016	No Restricted Materials Above Threshold
EU REACH Regulation (EC) No. 1907/2006	Current ECHA Candidate List: JUNE 2024 (241) Candidate List Declared Against: JUNE 2024 (241) Does not contain REACH SVHC
Halogen Content	Low Halogen - Br, Cl, F, I < 900 ppm per homogenous material. Also BFR/CFR/PVC Free
Solder Process Capability	Not applicable for solder process capability

Product Compliance Disclaimer

This information is provided based on reasonable inquiry of our suppliers and represents our current actual knowledge based on the information they provided. This information is subject to change. The part numbers that TE has identified as EU RoHS compliant have a maximum concentration of 0.1% by weight in homogenous materials for lead, hexavalent chromium, mercury, PBB, PBDE, DBP, BBP, DEHP, DIBP, and 0.01% for cadmium, or qualify for an exemption to these limits as defined in the Annexes of Directive 2011/65/EU (RoHS2). Finished electrical and electronic equipment products

will be CE marked as required by Directive 2011/65/EU. Components may not be CE marked. Additionally, the part numbers that TE has identified as EU ELV compliant have a maximum concentration of 0.1% by weight in homogenous materials for lead, hexavalent chromium, and mercury, and 0.01% for cadmium, or qualify for an exemption to these limits as defined in the Annexes of Directive 2000/53/EC (ELV). Regarding the REACH Regulation, the information TE provides on SVHC in articles for this part number is based on the latest European Chemicals Agency (ECHA) 'Guidance on requirements for substances in articles' posted at this URL: <https://echa.europa.eu/guidance-documents/guidance-on-reach>

Compatible Parts

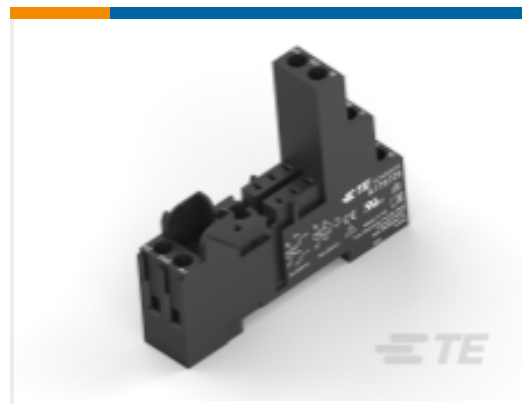

TE Part # 6-1415035-1
RT78726

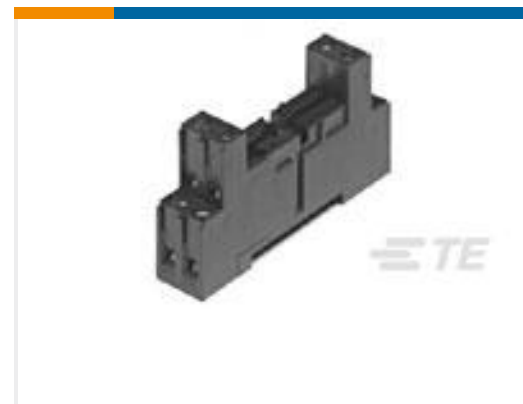

TE Part # 1860306-1
RT78725

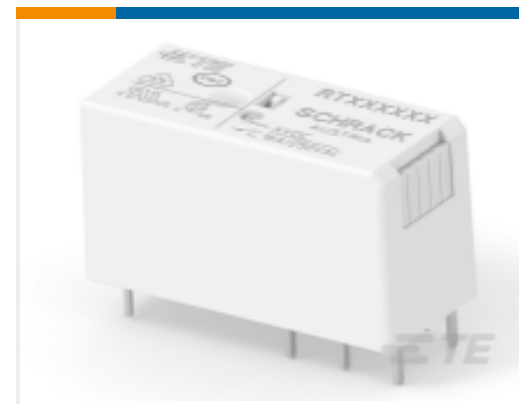

TE Part # 1-1419108-1
RT315730

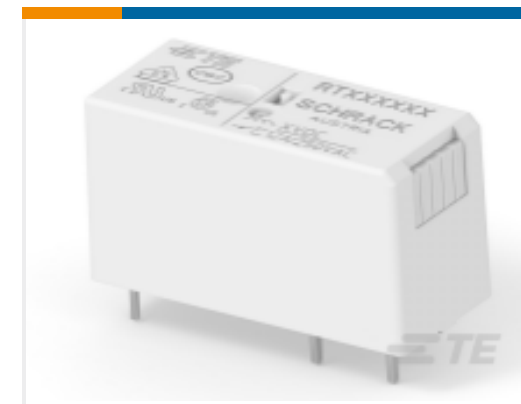

TE Part # 1393239-8
RT114006

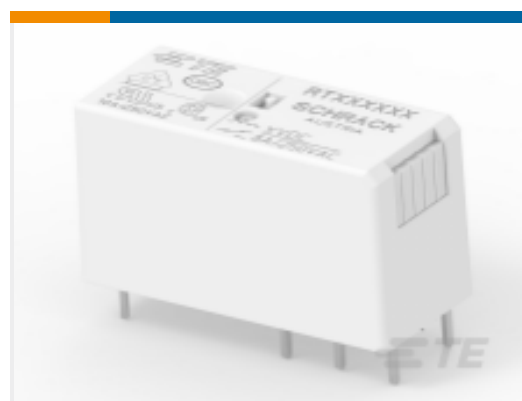

TE Part # 7-1393243-8
RT424615

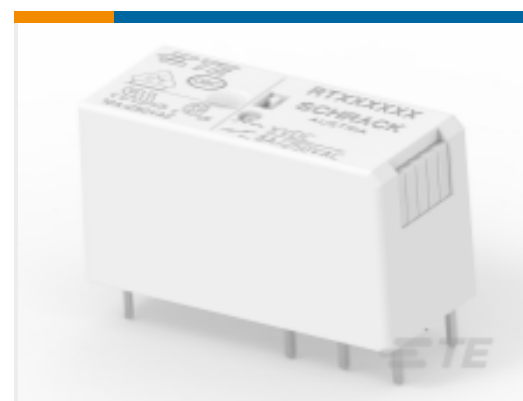

TE Part # 7-1393243-6
RT424524

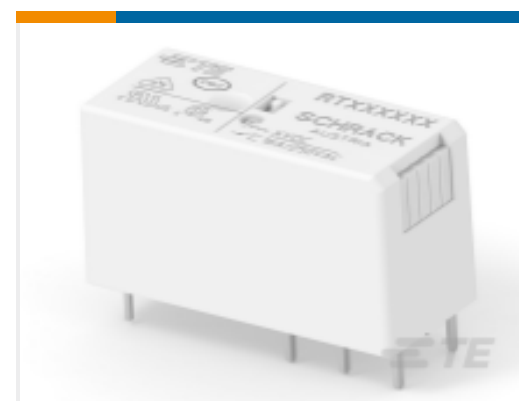

TE Part # 1-1393240-4
RT315024

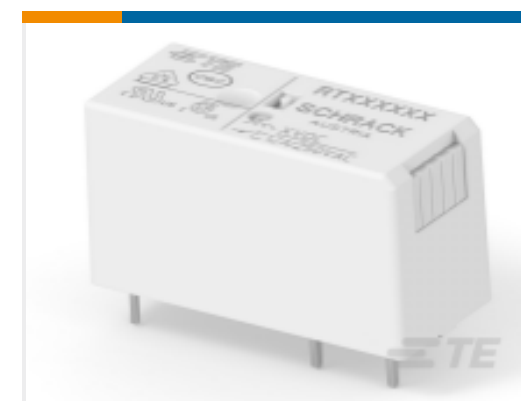

TE Part # 2-1393239-6
RT134012

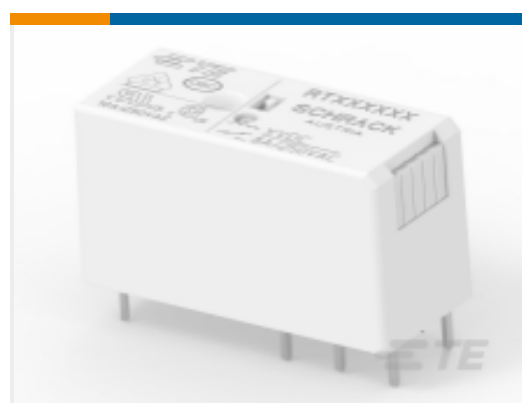

TE Part # 6-1393243-2
RT424009

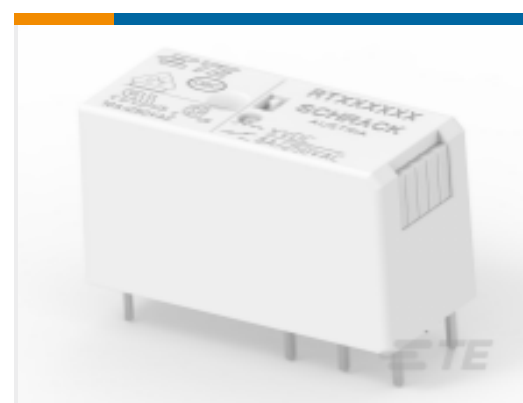

TE Part # 2-1393243-1
RTE25024



TE Part # 8-1415035-1
RT78724

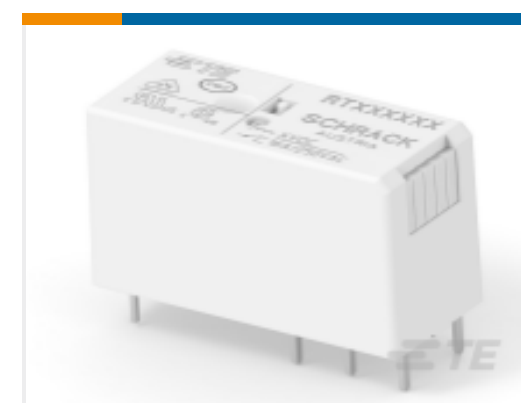

TE Part # 1393240-4
RT314524

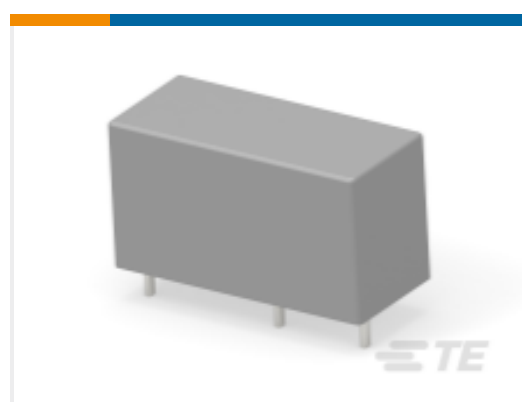

TE Part # 1419108-6
RT214730

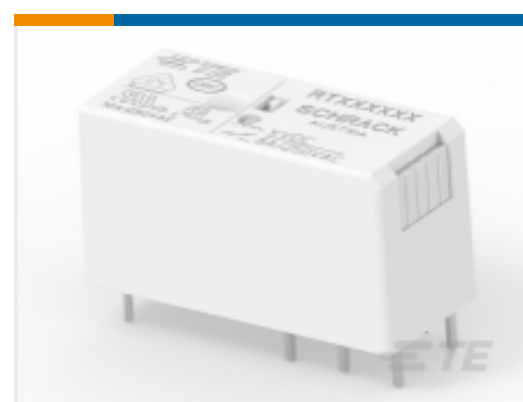

TE Part # 1393243-2
RTE24006

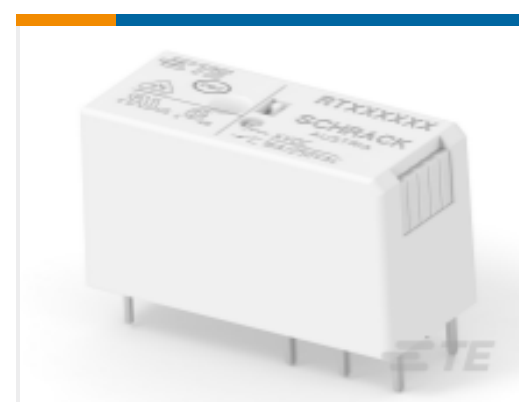

TE Part # 1393240-3
RT314110

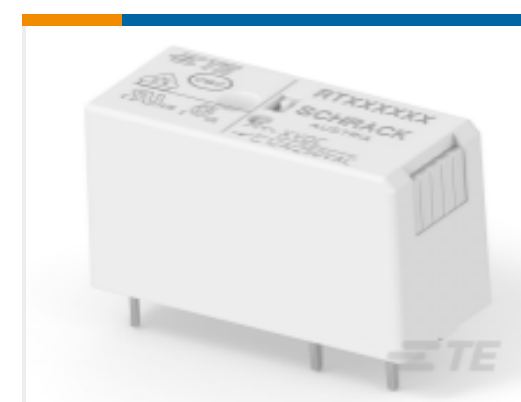

TE Part # 1-1393239-9
RT114730



Also in the Series | SCHRACK Accessories PT/RT/XT

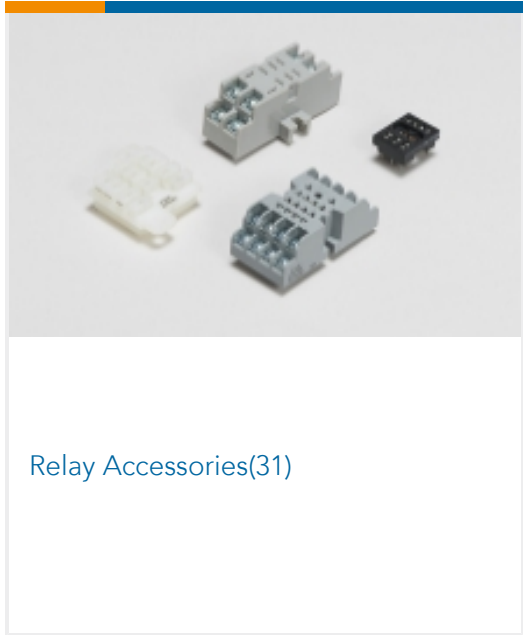

Customers Also Bought





Documents

CAD Files

3D PDF

3D

Customer View Model

[ENG_CVM_CVM_2022103-1_B_c-2022103-1-b.2d_dxf.zip](#)

English

Customer View Model

[ENG_CVM_CVM_2022103-1_B_c-2022103-1-b.3d_igs.zip](#)

English

Customer View Model

[ENG_CVM_CVM_2022103-1_B_c-2022103-1-b.3d_stp.zip](#)

English

By downloading the CAD file I accept and agree to the [Terms and Conditions](#) of use.

Datasheets & Catalog Pages

[Accessories - Power PCB Relay RT](#)

English

Product Specifications

[Definitions General Purpose Relays](#)

English