

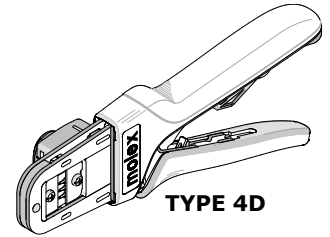

**Order Number  
213309-1200**

**Application Tooling Specification**



**FEATURES**

- A full cycle ratcheting hand tool ensures complete crimps
- Ergonomic soft grip handles for comfortable crimping
- A precision user-friendly terminal locator holds terminals in the proper crimping position
- Right- or left-handed operation
- Dies and locator from this tool can be used in the Battery Powered Tool Order No. 63816-0270 (110 V) or 63816-0280 (220 V), with the use of the 63816-0800 Crimp Head

**SCOPE**

**Products:** Milli-Grid and MicroBlade Crimp Terminals, 24-30 AWG.

Terminal Series No.	Terminal Order No.		Wire Size		Insulation Diameter		Strip Length	
	Loose Piece	* Reel	AWG	mm <sup>2</sup>	mm	In.	mm	In.
50394	50394-8100	50394-8051	24-30	0.20-0.05	0.80-1.40	.031-.055	1.30-1.80	.051-.071
	50394-8200	50394-8052						
	50394-8300	50394-8053						
	50394-8400	50394-8054						
		50394-8055						
50011	50011-8100	50011-8000	24-30	0.20-0.05	0.80-1.40	.031-.055	1.60-2.10	.063-.083

\* Customer to cut off terminal from reel: 0.15mm (.006") maximum cut-off tab.

**DEFINITION OF TERMS**

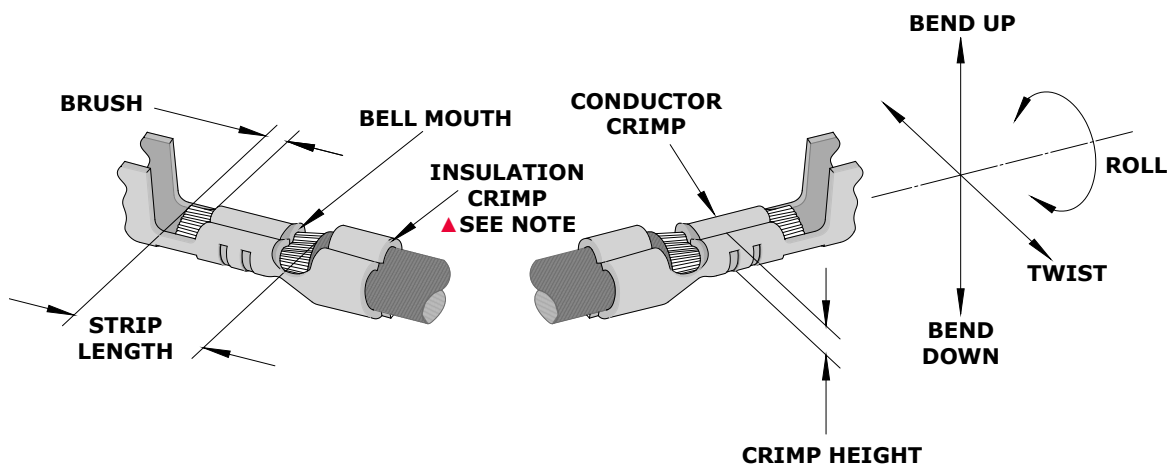

The above terminal drawing is a generic terminal representation. It is not an image of a terminal listed in the scope.

**▲ Insulation Crimp Note**

Due to the terminal’s insulation grip design or insulation diameter range, this tool uses overlap form geometry in the insulation punch. This produces an overlap insulation crimp (A-620-compliant). Although the insulation punch profile may appear lopsided, this is a normal condition for this tool. See figure to the right. (Some tools with multiple crimp pockets may not have the overlap profile on all pockets.)

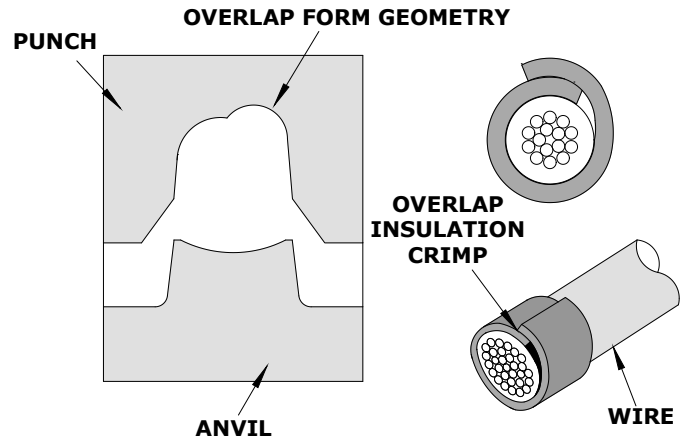

**CONDITIONS**

After crimping, the conductor profiles should measure the following:

Terminal Series No.	Wire Size		Conductor Crimp				Insulation Crimp				Pull Force Minimum		Profile		
			Height		Width (Ref.)		Height (Ref.)		Width (Ref.)						
	AWG	mm <sup>2</sup>	mm	In.	mm	In.	mm	In.	mm	In.	N	Lb.	24	26	28-30
50394	24	0.20	0.58-0.68	.023-.027	1.03	.041	1.43	.056	1.40	.055	29.4	6.60	X		
	26	0.12	0.53-0.63	.021-.025	1.04	.041	1.43	.056	1.32	.052	19.6	4.40		X	
	28	0.08	0.49-0.59	.019-.023	1.02	.040	1.33	.052	1.31	.052	9.8	2.2			X
	30	0.05	0.49-0.59	.019-.023	1.02	.040	1.31	.052	1.30	.051	4.9	1.10			X
50011	24	0.20	0.58-0.68	.023-.027	1.03	.041	1.40	.055	1.40	.055	29.4	6.60	X		
	26	0.12	0.53-0.63	.021-.025	1.04	.041	1.37	.054	1.32	.052	19.6	4.40		X	
	28	0.08	0.49-0.59	.019-.023	1.02	.040	1.33	.052	1.31	.052	9.8	2.2			X
	30	0.05	0.49-0.59	.019-.023	1.02	.040	1.31	.052	1.30	.051	4.9	1.10			X

Terminal Series No.	Wire Size		◆ Bell Mouth		Conductor Brush	
	AWG	mm <sup>2</sup>	mm	In.	mm	In.
50394	24	0.20	0.05-0.30	.002-.012	0.00-0.70	.000-.028
	26	0.12				
	28	0.08				
	30	0.05				
50011	24	0.20	0.05-0.30	.002-.012	0.00-0.70	.000-.028
	26	0.12				
	28	0.08				
	30	0.05				

**Tool Qualification Notes**

1. Pull force should be measured with no influence from the insulation crimp.
2. The above specifications are guidelines to an optimum crimp.

◆ **Bell Mouth Adjustment Notes**

The 213309-1200 hand crimp tool features an adjustable locator that allows the operator to increase or decrease the bell mouth and brush length specifications.

**Note:** The tool was set up in manufacturing and used to produce the included crimp samples, but it may be necessary to adjust the tool because of variations in terminal production.

Use a 1.5mm hex wrench to adjust to bell mouth size and brush length.

The adjustment screw is accessible through the hole in the side of the terminal locator on the back of the hand crimp tool. See Figure 1.

To increase bell mouth and brush length, turn the screw clockwise.

To decrease bell mouth and brush length, turn the screw counterclockwise.

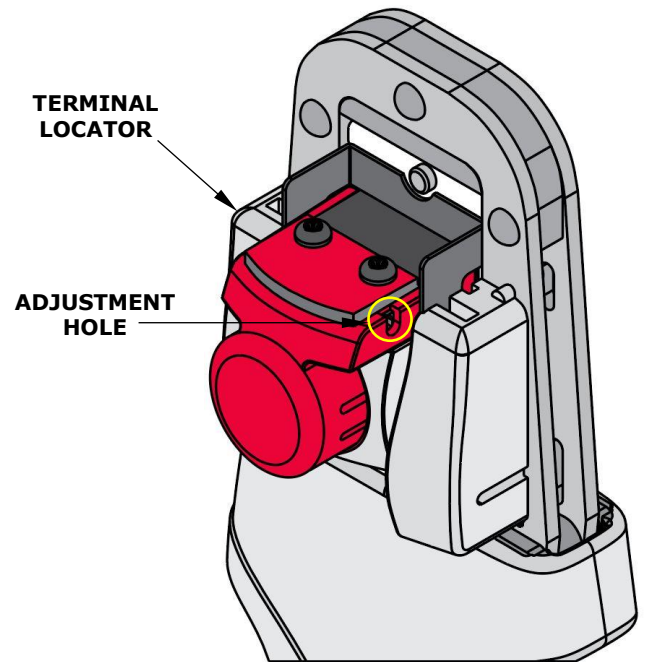
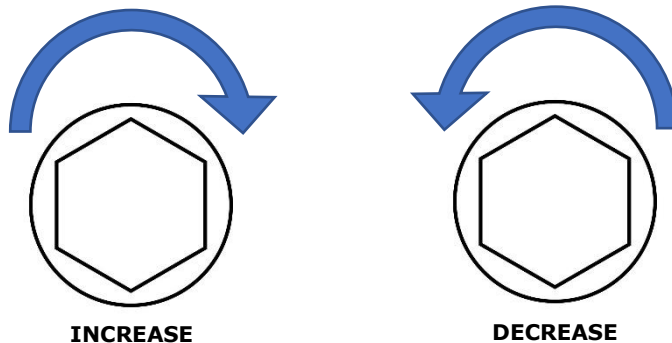

Figure 1

When making an adjustment, turn the adjustment screw half a rotation or less, and then re-check your bell mouth and brush length.

If you feel or hear a click during the rotation, you have reached the limits of the adjustment.

Once the bell mouth and brush length are properly adjusted, follow the tool operation instructions listed below.

## OPERATION



**CAUTION:** Crimp only the Molex terminals listed in the scope for this tool. Do not crimp hardened objects as damage can occur to the tool frame or crimp dies.

Open the tool by squeezing the handles together. At the end of the closing stroke, the ratchet mechanism will release the handles and the hand tool will spring open. See Figure 2.

### Crimping Terminals

1. Select the desired terminal listed in the preceding charts.
2. Make sure the center of the locator is in the down position. With the locator attached, push the locator button on the back of the hand tool to bring the locator forward through the tooling. See Figure 3.
3. While holding the locator button in, load the terminal into the proper nest opening in the locator based on the wire gauge or terminal type markings on the hand tooling. See Figure 4.

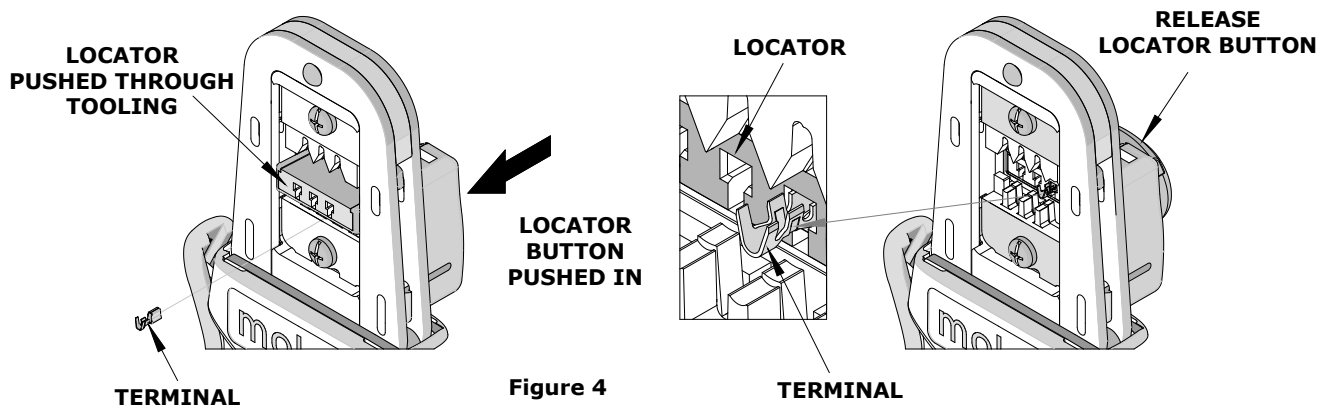
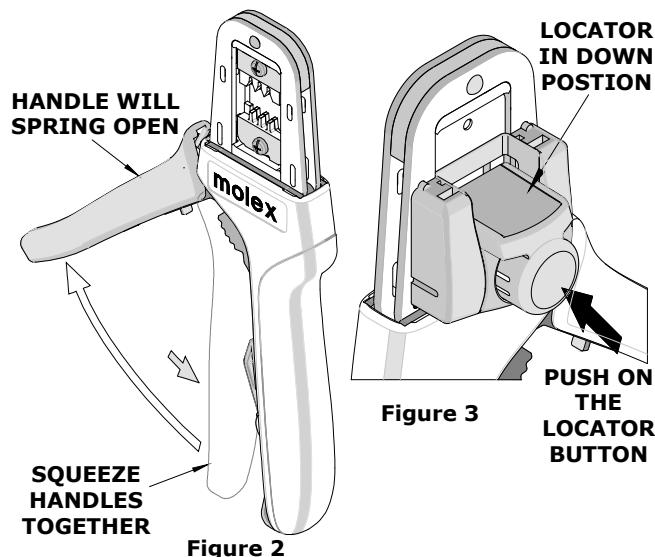

4. Release the locator button, allowing the locator to return to the crimping position.
5. Close the tool handle until the first ratchet position engages. See Figure 5.
6. Insert the properly stripped wire through the terminal and against the wire stop. See Figure 6.
7. Crimp the terminal by squeezing the tool handles until the ratchet mechanism cycle has been completed. Release the handles to open the jaws.

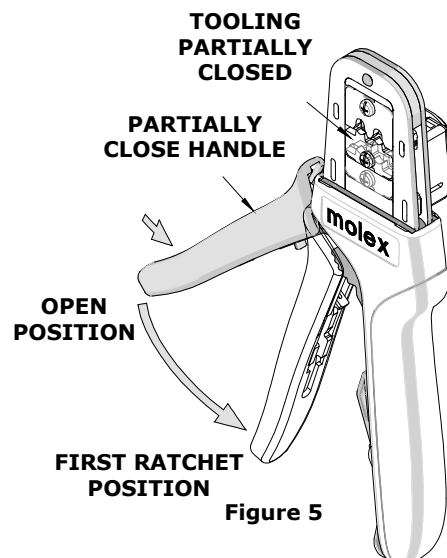

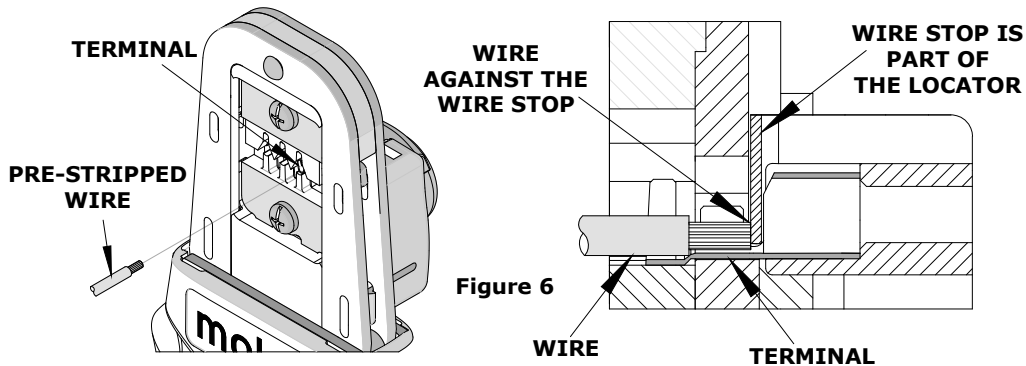

**Note:** The tamper-proof ratchet action will not release the tool until it has been fully closed.

8. Remove the crimped terminal from the terminal locator by pulling on the wire.
9. Visually inspect the crimped terminal for proper crimp location.
10. On some large O.D. wires, it may not be possible to insert the wire with the tool partially closed. Those wires should be inserted with the hand tool in the open position. Insert the wire above the terminal in the punch and against the wire stop, and then close the tool. See Figure 7.

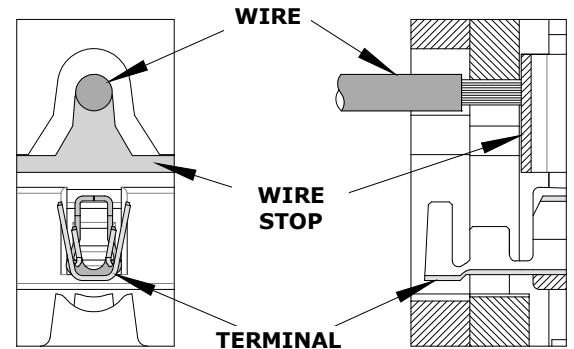

### Locator Replacement

See the parts list on the last page of this document for the proper locator order number. Follow the steps below to replace the locator.

1. Open the crimp hand tool.
2. Squeeze gently on the lower area shown in Figure 8A with your thumb and index finger. The lower tabs of the locator should disengage from the hand tool.
3. Lift and pull away from the hand tool. The top locator hooks should slip out of the top slots easily. See Figure 8A.
4. To reinstall the new locator, make sure the hand tool is in the open position.
5. Press the center of the locator down as far as it will go as shown in Figure 8B.
6. Holding onto the lower part of the locator with your thumb and index finger, insert the locator's top hooks into the hand tool's top slots.
7. Rotate the locator down and press the lower tabs into the two bottom slots of the hand tool. To secure the locator into place, the lower tabs must snap into place on the hand tool frame.

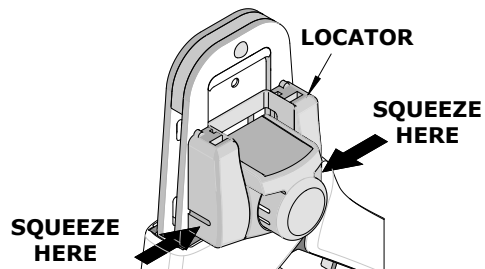

Figure 8A

**MAKE SURE CENTER OF LOCATOR IS IN THE DOWN POSITION**

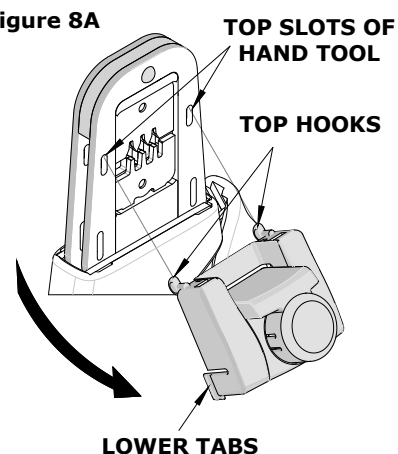

Figure 8B

## Right- or Left-Handed Operation

This hand tool has an added feature that can be converted from a right-handed application to a left-handed application. It is necessary to reverse the tooling if using the left-handed application along with the locator. Follow the steps below:

1. The locator must be removed before reversing the tooling.
2. Remove the M3 BHCS, which is holding the upper tooling.
3. Flip the upper tooling to the opposite side, and replace the M3 BHCS. Make sure the small markings on the front and back of the hand tool frame match up and are on the outside of the hand tool frame. See Figures 9 and 10.
4. Do the same thing with the lower tooling, and tighten the M3 screws. Be sure the small markings line up.
5. Reinstall the locator by following the instructions in the locator replacement section.

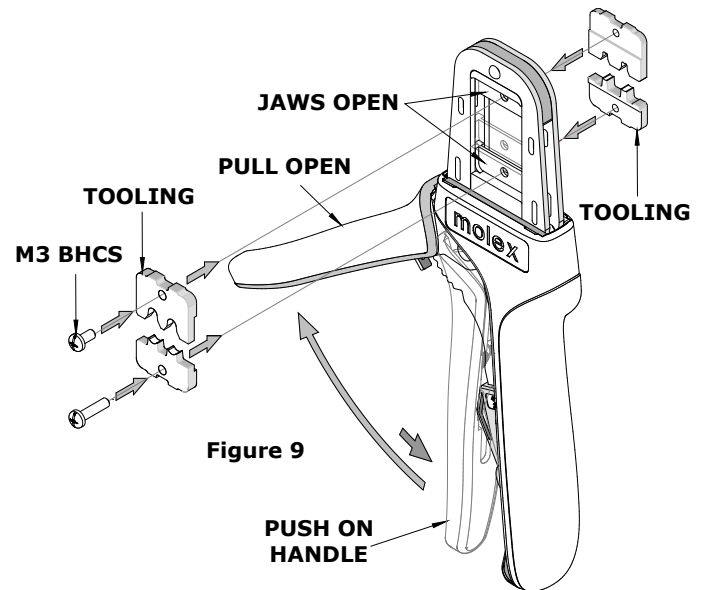

Figure 9

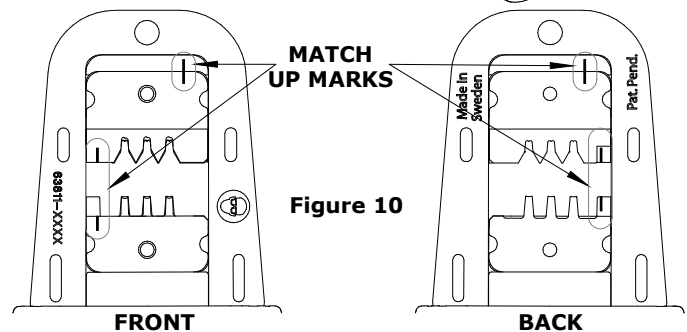

Figure 10

## MAINTENANCE

It is recommended that each operator of the tool be made aware of and responsible for the following maintenance steps:

1. Remove dust, moisture and other contaminants with a clean brush or a soft, lint-free cloth.
2. Do not use any abrasive materials that could damage the tool.
3. Make certain all pins, pivot points and bearing surfaces are protected with a thin coat of high-quality machine oil. Do not oil excessively. The tool was engineered for durability, but like any other equipment, it needs cleaning and lubrication for a maximum service life of trouble-free crimping. Light oil (such as 30 weight automotive oil) used at the oil points every 5,000 crimps or 3 months will significantly enhance the tool life. See Figure 11.
4. Wipe excess oil from hand tool, particularly from crimping area. Oil transferred from the crimping area onto certain terminations may affect the electrical characteristics of an application.
5. When the tool is not in use, keep the handles closed to prevent objects from becoming lodged in the crimping dies, and store the tool in a clean, dry area.

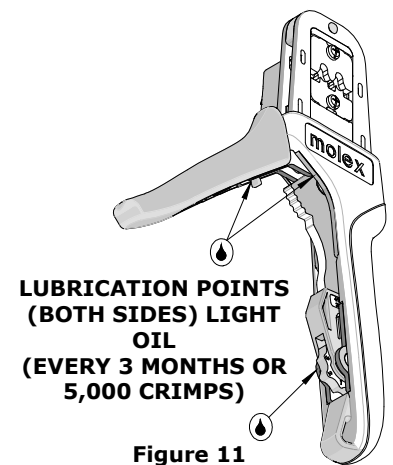

Figure 11

## Miscrimps or Jams

Should this tool ever become stuck or jammed in a partially closed position, **Do Not force the handles open or closed.** The tool will open easily by pressing up on the ratchet release lever in the movable handle. See Figure 12.

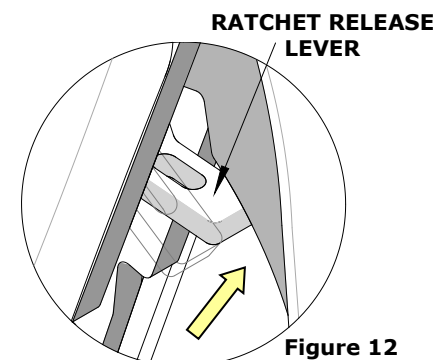

Figure 12

### How to Adjust Tool Preload (See Figure 13)

This hand tool is factory preset to 25-45 pounds preload. It may be necessary over the life of the tool to adjust tool handle preload force. Listed below are the steps required to adjust the crimping force of the hand tool to obtain proper crimp conditions:

1. Hold the hand tool in the palm of your hand as shown in Figure 13. Using your index finger, squeeze the link toward the top of the hand tool frame. This will release the preload adjustment wheel.
2. Rotate the setting wheel counterclockwise (CCW) to increase handle force. The numbers will display higher. To decrease handle force, rotate the setting wheel clockwise (CW).
3. Release the link to lock the setting wheel in place.
4. Check the crimp specifications or conduct a pull test after tool handle preload force is adjusted.

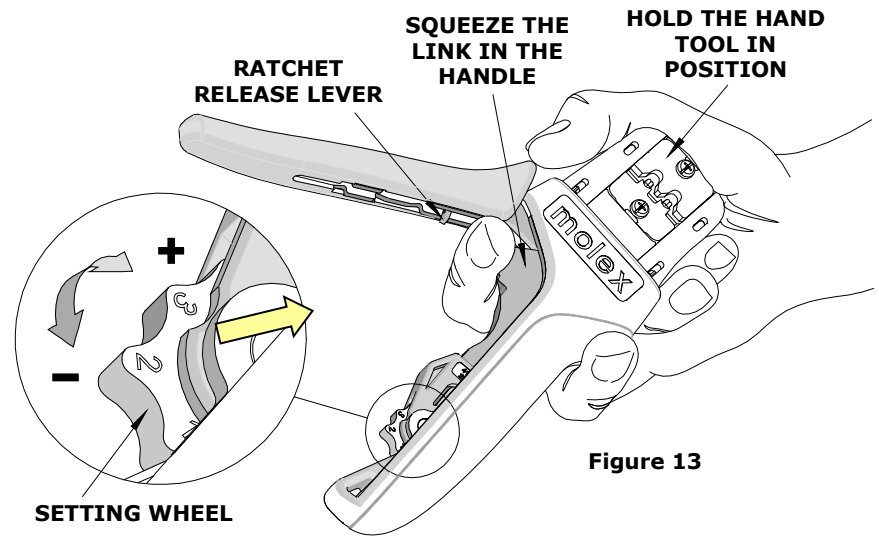

Figure 13

### WARRANTY

This tool is for electrical terminal crimping purposes only. This tool is made of the best quality materials. All vital components are long-life tested. All tools are warranted to be free of manufacturing defects for a period of 30 days. Should such a defect occur, Molex will repair or exchange the tool free of charge. This repair or exchange will not be applicable to altered, misused or damaged tools. This tool is designed for hand use only. Any clamping, fixturing or use of handle extensions voids this warranty.

**CAUTION:** Molex crimp specifications are valid only when used with Molex terminals and tooling.

### CAUTIONS:

1. Manually powered hand tools are intended for low-volume use or field repair. This tool is **NOT** intended for production use. Repetitive use of this tool should be avoided.
2. Insulated rubber handles are not protection against electrical shock.
3. Wear eye protection at all times.
4. Use only the Molex terminals specified for crimping with this tool.

### Certification

Molex does not certify or re-certify hand tools but rather supplies the following guidelines for customers to re-certify hand tools:

- This tool is qualified to pull force only. See the Molex website for the Quality Crimp Handbook for more information on pull testing.
- If the tool does not meet minimum pull force values, handle preload should be increased and the pull test rerun. See the How to Adjust Preload section.
- When the hand tool is no longer capable of achieving minimum pull force, it should be taken out of service and replaced.

**PARTS LIST**

Item Number	Order Number	Description	Quantity
REF	213309-1200	Hand Crimp Tool	Figure 14
1	213309-1275	Locator Assembly	1
2	63810-0104	Spring, Return	1
3	63810-0105	Spring, Ratchet	1

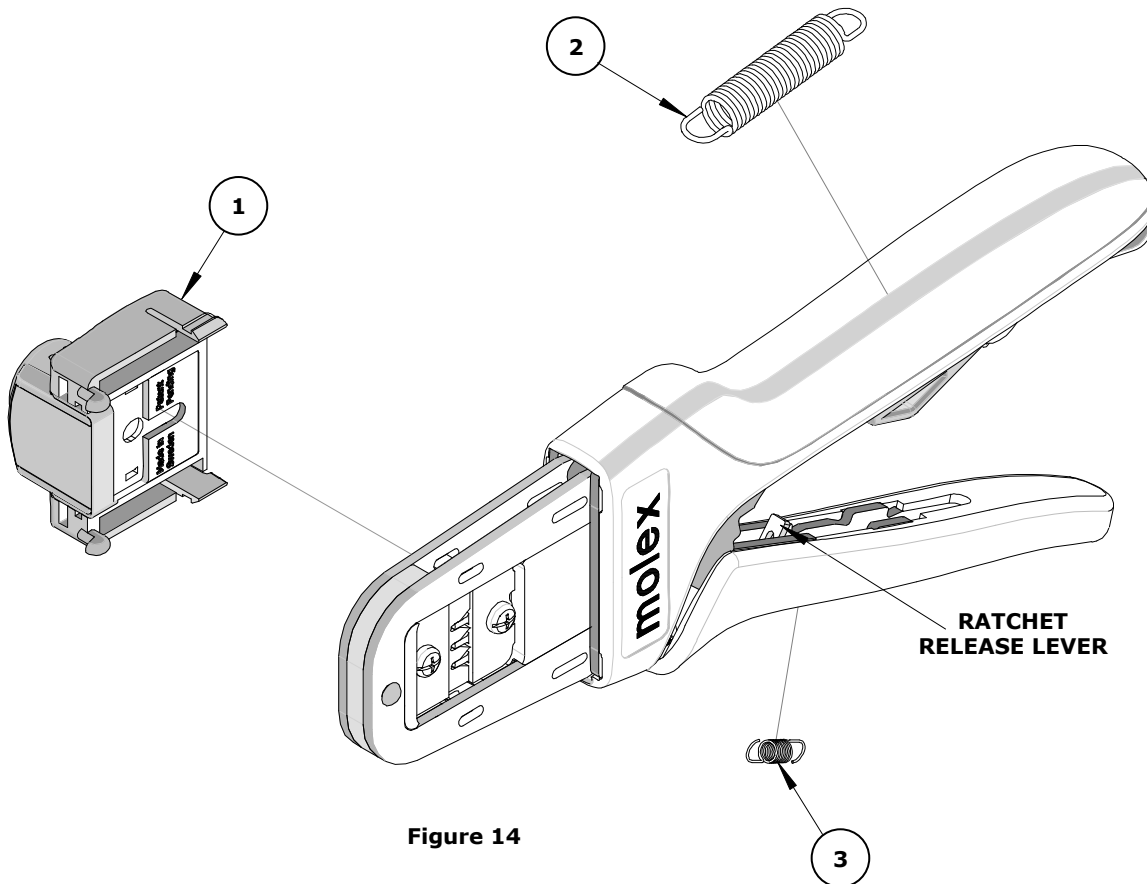

Figure 14

**Application Tooling Support**

**Phone:** (402) 458-TOOL (8665)  
**E-Mail:** applicationtooling@molex.com  
**Website:** www.molex.com/applicationtooling

Molex is a registered trademark of Molex, LLC in the United States of America and may be registered in other countries; all other trademarks listed herein belong to their respective owners.