

Coaxial Two Way Plug-in Switch (DPDT) || BN 553365

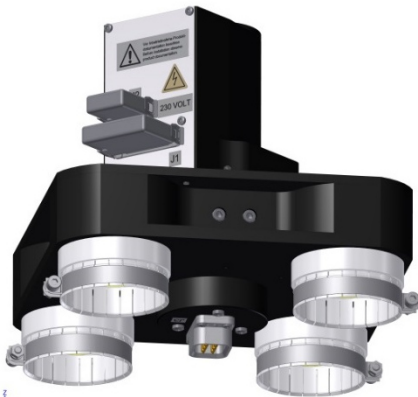

Product manual: M36274

Radio frequency characteristics

Interface type (4 connections)	29.5-68 USL-D according to company standard 61774		
Characteristic impedance	50 Ω		
Frequency range	0 to 100 MHz	100 to 230 MHz	230 to 860 MHz
VSWR, max.	1.04	1.04	1.04
Isolation, min.	80 dB	80 dB	70 dB
Insertion loss, max.	0.1 dB	0.1 dB	0.1 dB
Average power capability *	41 kW	27 kW	14 kW
Peak voltage capability *	8.1 kV		

Electrical and mechanical data

Switch type	Two way switch, DPDT	
Actuator type	Motor drive, latching, self cutoff	
Strapping plug for USL-interlock I	Connector J3 ***	8 pole SPINNER connector BN 125651
	Maximum ratings	SELV circuits according to IEC-EN-60950-1, 42.4 V ACpk / 60 V DC / 0.5 A
	Nominal fuse	The circuits must be externally limited to 0.5 A
Connector J2 ** for mains connection	5 pole SPINNER connector BN 126920, certified according to VDE-Reg. No. B687, DIN EN 61984: 2009-11; EN 61984: 2009	
Mains connection	L, N, PE, TN-System	
Operating	Operating voltage	230 V AC ±10% 50/60 Hz
	Current, typ. ****	1 A
	Nominal fuse	The switch must be externally fused by time-delay, 2 A
Connector J1 ** for interlock contacts and signaling	25 pole connector according to DIN 41652 / IEC 807-2	
Signal contacts Interlock contacts	Maximum ratings	SELV circuits according to IEC EN 60950-1, 42.4 V ACpk / 60 V DC / 0.5 A
	Nominal fuse	The circuit must be externally limited to 0.5 A

Template TD-00002S

Coaxial Two Way Plug-in Switch (DPDT) || BN 553365

Switching time, typ.****	0.2 s
Command hold time, min.	0.2 s (during this time, the voltage at control input must not change)
Switching frequency, max.	10 operations per minute
Life, min.	250,000 operations
Weight, approx.	9 kg

Environmental conditions

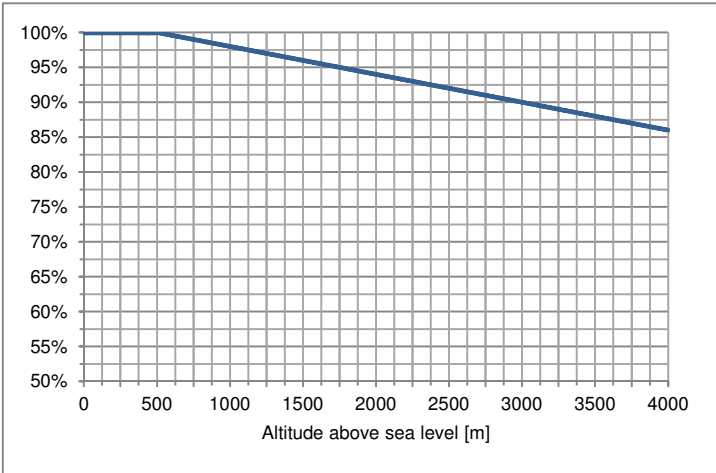
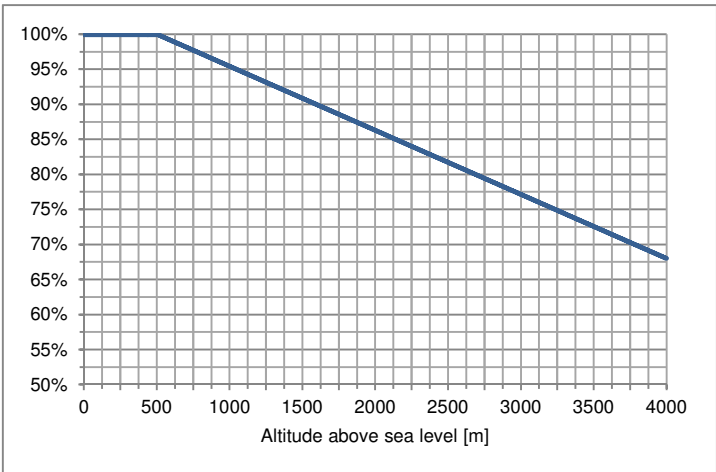
Operational conditions	ETSI EN 300 019-1-3 V2.3.2 (2009-1) class 3.1 N																				
Ambient temperature *****	-10 to +45°C																				
Condensation	Not allowed																				
Relative humidity, max.	95%																				
Derating of input power with increasing altitude	<p>The maximum input power can be applied up to 500 m or 1600 ft above sea level unless noted otherwise in the data sheet. Above this height the maximum input power must be reduced as shown in the diagram.</p>  <table border="1"> <caption>Derating of input power with increasing altitude</caption> <thead> <tr> <th>Altitude above sea level [m]</th> <th>Power (%)</th> </tr> </thead> <tbody> <tr><td>0</td><td>100</td></tr> <tr><td>500</td><td>100</td></tr> <tr><td>1000</td><td>97.5</td></tr> <tr><td>1500</td><td>95</td></tr> <tr><td>2000</td><td>92.5</td></tr> <tr><td>2500</td><td>90</td></tr> <tr><td>3000</td><td>87.5</td></tr> <tr><td>3500</td><td>85</td></tr> <tr><td>4000</td><td>82.5</td></tr> </tbody> </table>	Altitude above sea level [m]	Power (%)	0	100	500	100	1000	97.5	1500	95	2000	92.5	2500	90	3000	87.5	3500	85	4000	82.5
Altitude above sea level [m]	Power (%)																				
0	100																				
500	100																				
1000	97.5																				
1500	95																				
2000	92.5																				
2500	90																				
3000	87.5																				
3500	85																				
4000	82.5																				
Derating of voltage with increasing altitude	<p>The maximum voltage can be applied up to 500 m or 1600 ft above sea level unless noted otherwise in the data sheet. Above this height the maximum input power must be reduced as shown in the diagram.</p>  <table border="1"> <caption>Derating of voltage with increasing altitude</caption> <thead> <tr> <th>Altitude above sea level [m]</th> <th>Voltage (%)</th> </tr> </thead> <tbody> <tr><td>0</td><td>100</td></tr> <tr><td>500</td><td>100</td></tr> <tr><td>1000</td><td>95</td></tr> <tr><td>1500</td><td>90</td></tr> <tr><td>2000</td><td>85</td></tr> <tr><td>2500</td><td>80</td></tr> <tr><td>3000</td><td>75</td></tr> <tr><td>3500</td><td>70</td></tr> <tr><td>4000</td><td>65</td></tr> </tbody> </table>	Altitude above sea level [m]	Voltage (%)	0	100	500	100	1000	95	1500	90	2000	85	2500	80	3000	75	3500	70	4000	65
Altitude above sea level [m]	Voltage (%)																				
0	100																				
500	100																				
1000	95																				
1500	90																				
2000	85																				
2500	80																				
3000	75																				
3500	70																				
4000	65																				

Coaxial Two Way Plug-in Switch (DPDT) || BN 553365

Max. altitude above sea level	4,000 m or 13,120 ft according to IEC EN 60664-1
Protection class	I according to IEC EN 61140
IP protection level	IP40 according to IEC EN 60529 (all interfaces terminated)
Installation position	Any
Transport conditions	ETSI EN 300 019-1-2 V2.1.4 (2003-04) class 2.2
Ambient temperature	-25 to +70°C
Rain, condensation, icing	Not allowed
Storage conditions	ETSI EN 300 019-1-1 V2.1.4 (2003-04) class 1.2
Ambient temperature	-10 to +45°C
Rain, condensation, icing	Not allowed

- * *Standard conditions:*
Dielectric: Dry air under standard pressure at sea level (p = 1013 hPa)
Load VSWR, max. 1.0 (no standing wave)
No modulation, sinusoidal carrier only
- ** *Suitable mating connector included*
- *** *Suitable SPINNER mating connector BN 539145 not in delivery!*
- **** *At room temperature and nominal voltage 230 V AC*
- ***** *Extended temperature range on request*

Power handling vs. frequency

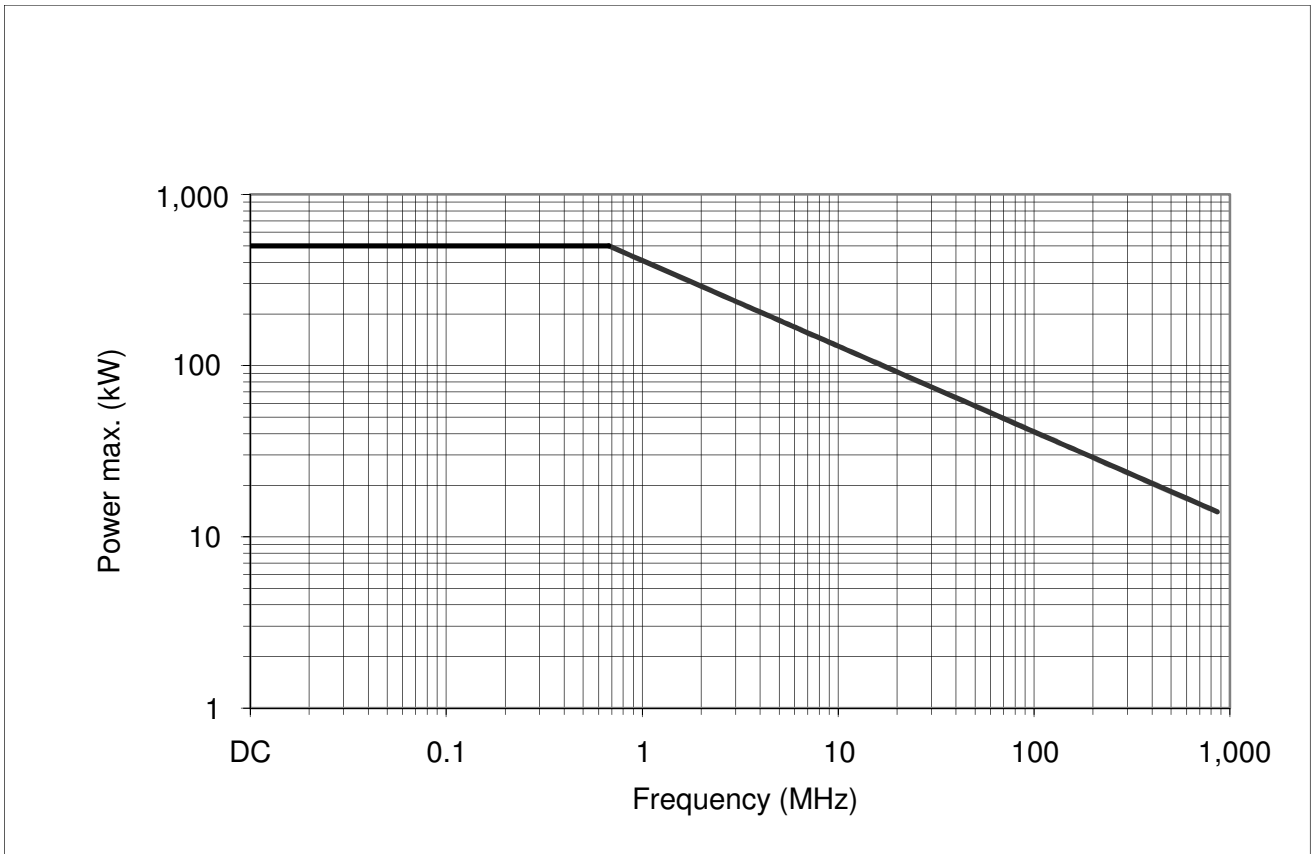

Coaxial Two Way Plug-in Switch (DPDT) || BN 553365

Typical diagram

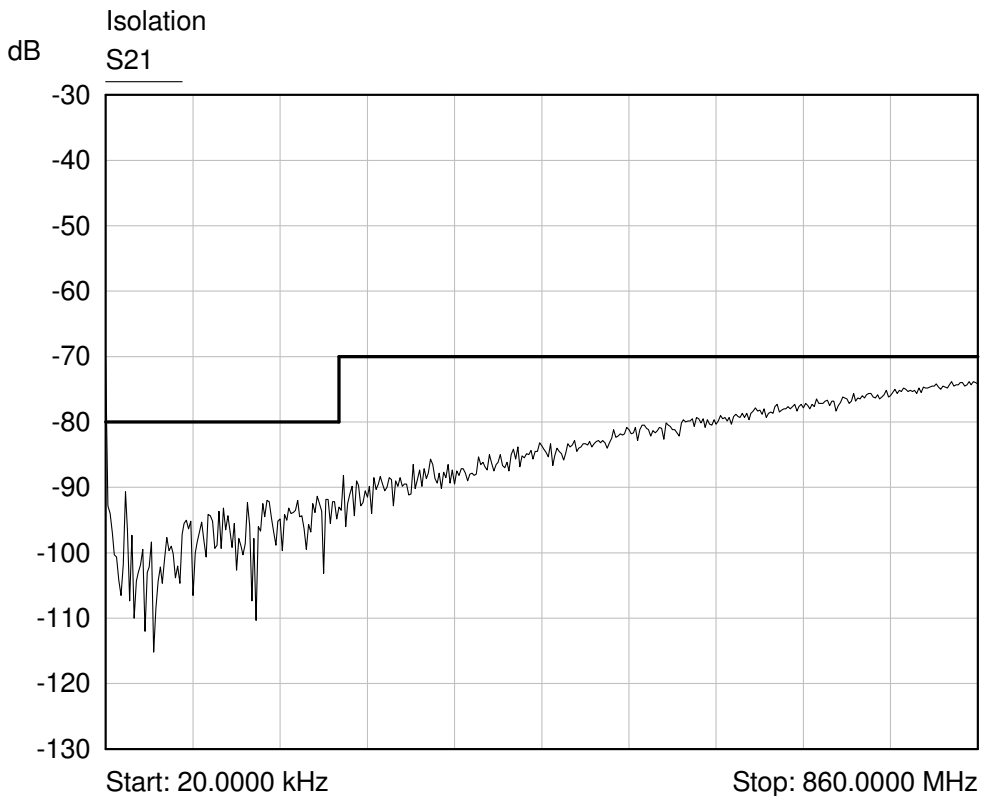
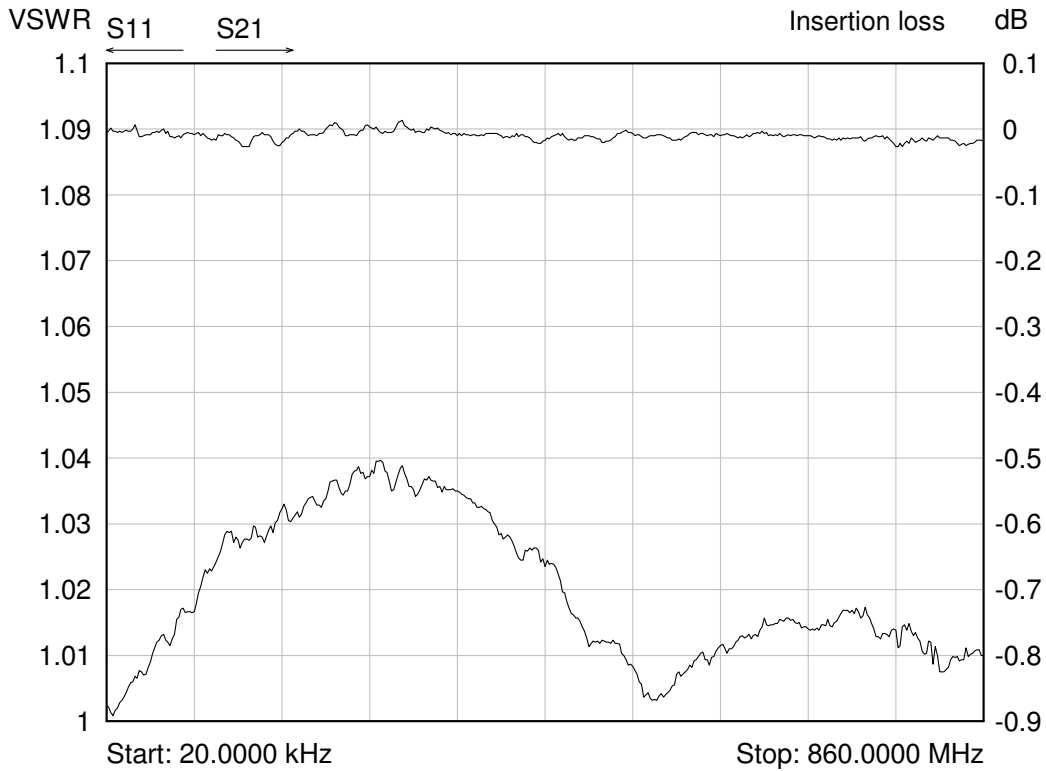

Coaxial Two Way Plug-in Switch (DPDT) || BN 553365

Outline (all dimensions in millimeters)

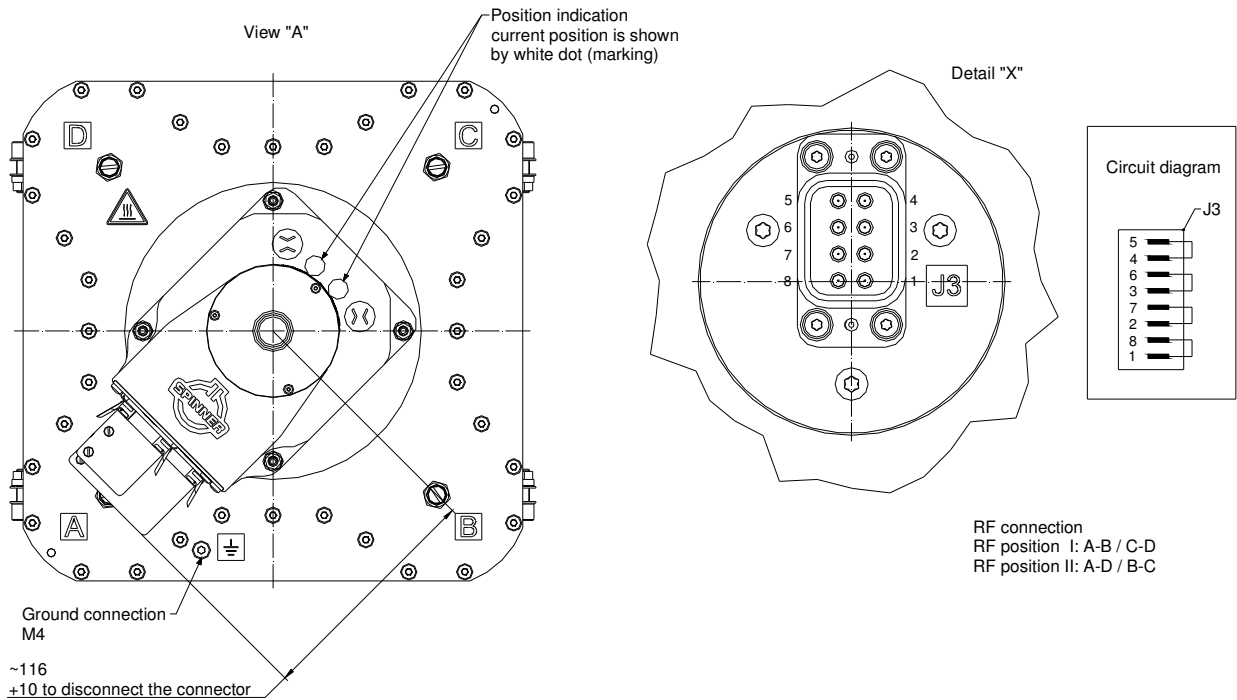
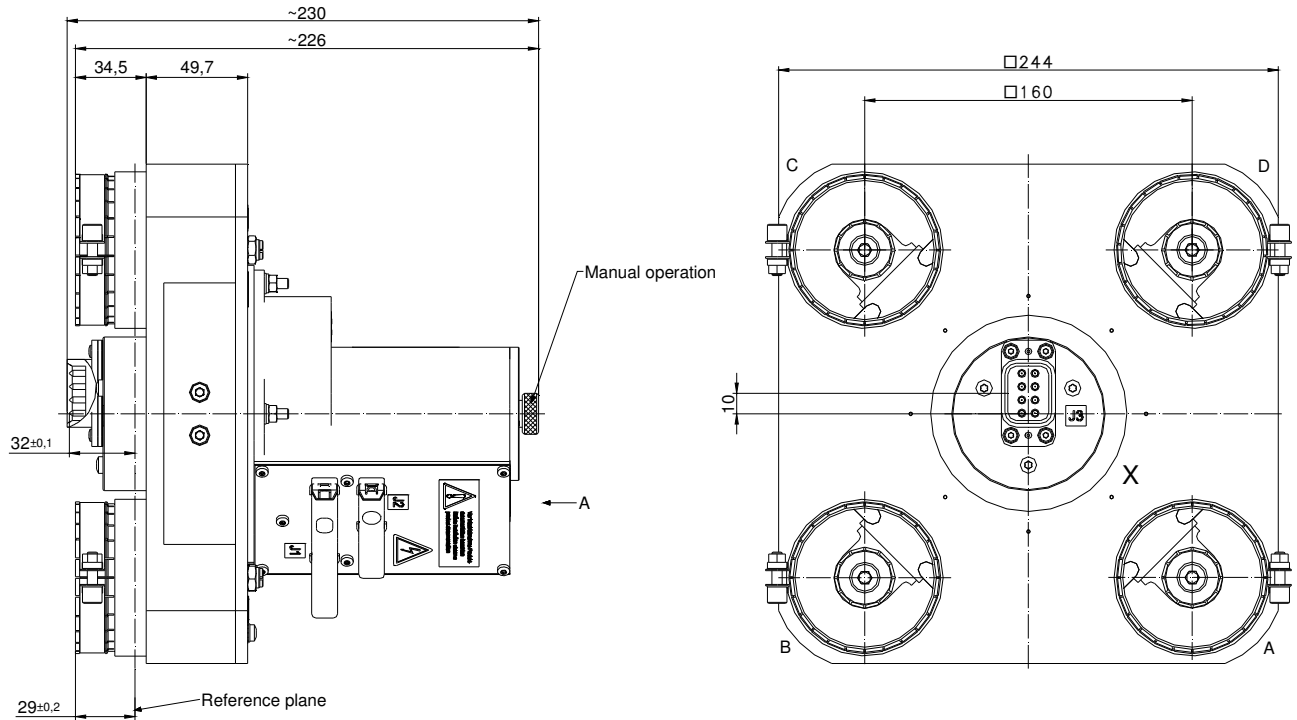

Template TD-00002S

Coaxial Two Way Plug-in Switch (DPDT) || BN 553365

Circuit diagram (B41001-CD, Issue E)

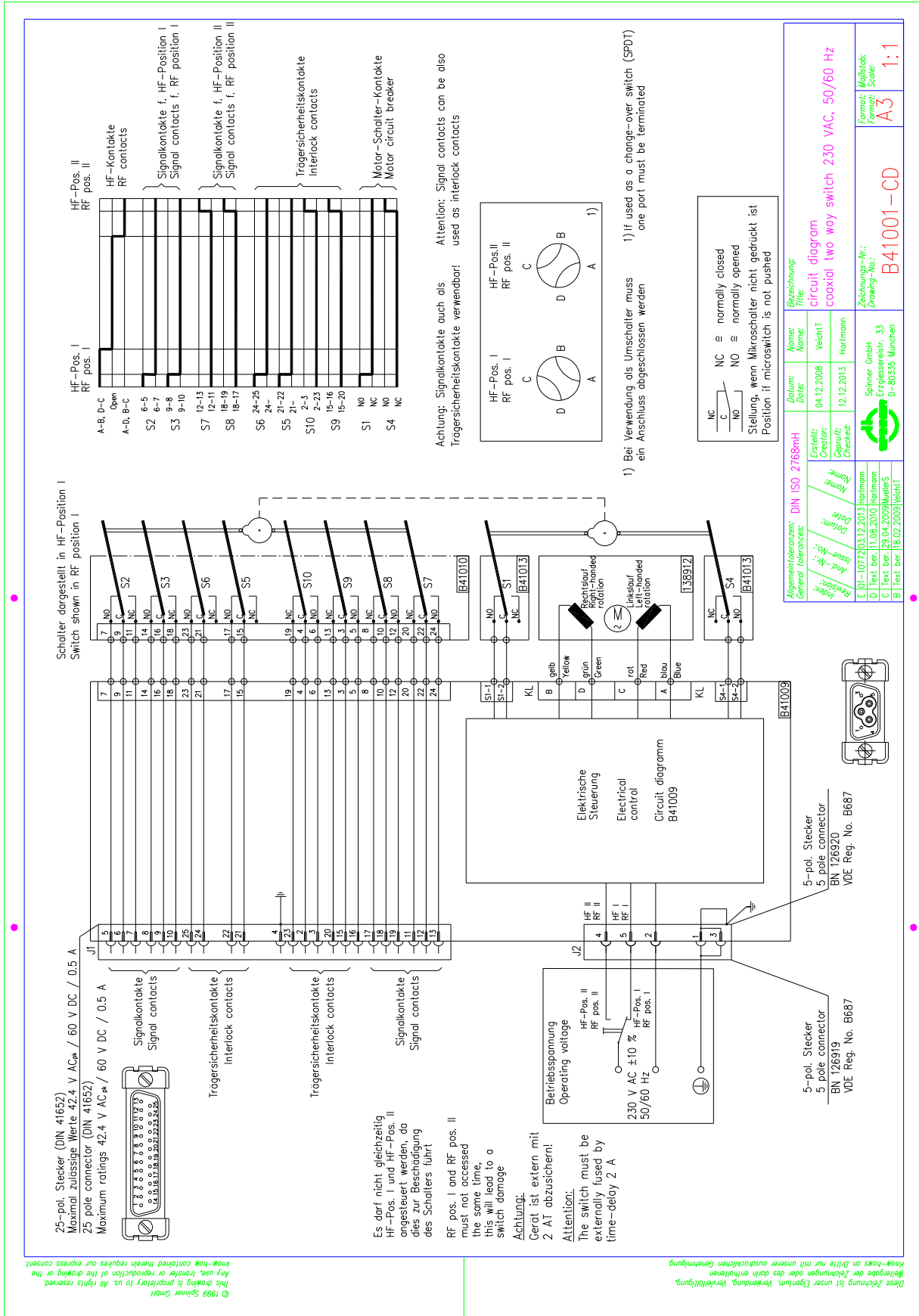

Achtung: Signalkontakte auch als Trägersicherheitskontakte verwendbar: Attention: Signal contacts can be also used as interlock contacts

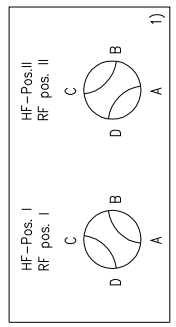

NC normally closed
NO normally opened
Stellung, wenn Mikroschalter nicht gedrückt ist
Position if microswitch is not pushed

Allgemeine Referenzen: DIN ISO 2768-mH General tolerances: DIN ISO 2768-mH	Name: 2768-mH Datum: 04.12.2008 Erstellt: 04.12.2008 Geprüft: 12.12.2013 Name: Veit HT Datum: 12.12.2013 Geprüft: Hartmann	Name: circuit diagram Datum: 04.12.2008 Erstellt: 04.12.2008 Geprüft: 12.12.2013 Name: Veit HT Datum: 12.12.2013 Geprüft: Hartmann	Name: coaxial two way switch Datum: 04.12.2008 Erstellt: 04.12.2008 Geprüft: 12.12.2013 Name: Veit HT Datum: 12.12.2013 Geprüft: Hartmann	Name: B41001-CD Datum: 04.12.2008 Erstellt: 04.12.2008 Geprüft: 12.12.2013 Name: Veit HT Datum: 12.12.2013 Geprüft: Hartmann	Name: A3 Datum: 04.12.2008 Erstellt: 04.12.2008 Geprüft: 12.12.2013 Name: Veit HT Datum: 12.12.2013 Geprüft: Hartmann	Name: 1:1 Datum: 04.12.2008 Erstellt: 04.12.2008 Geprüft: 12.12.2013 Name: Veit HT Datum: 12.12.2013 Geprüft: Hartmann
---	--	--	---	--	---	--

Coaxial Two Way Plug-in Switch (DPDT) || BN 553365

Cable socket (126919-0E, Issue D)

© 1999 Spinner GmbH Elektrotechnische Fabrik
This drawing is the property of Spinner GmbH.
Any use, transfer or reproduction of this drawing or the
know-how contained therein requires our express consent.

Anleitung für den Kabelanschluss
Instructions for cable connection

1. Entfernen des Schutzgehäuses
Removing of the protective housing

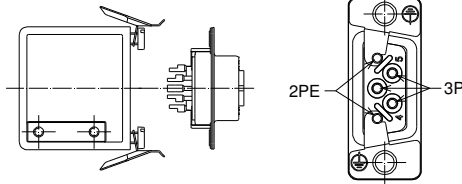

2. Absetzen der Kabellitzen
Trimming of the cable strands



3. Anbringen der drei Schrumpfschläuche (PIN 2/4/5)
3.a Placing of the three heat shrinks (pins 2/4/5)
3.b Lötten der fünf Kabellitzen
3.b Soldering of the five cable strands

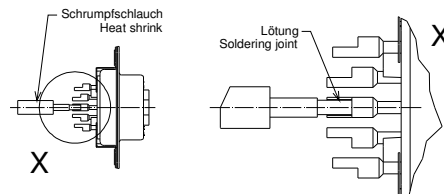

4. Aufschumpfen der drei Schrumpfschläuche (PIN 2/4/5)
4.a Shrinking three heat shrinks (pins 2/4/5)
4.b Montage des Schutzgehäuses
4.b Assembling of the protective housing

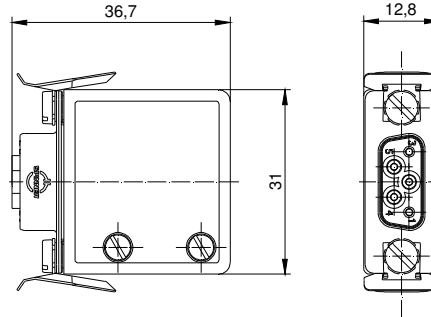
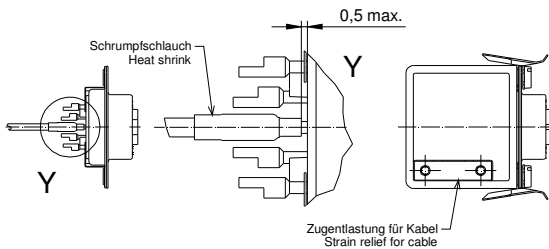

Technical data

5-polige Kabelkupplung 5 pole cable socket	ohne Schaltleistung Without breaking capacity
Bemessungsspannung Rated voltage	250 V AC
Bemessungsstrom Rated current	2 A
Bemessungsstoßspannung Rated impulse voltage	2.5 kV
Polzahl Number of poles	3P + 2PE
Anschlussart Kind of termination	Lötanschluss Solder termination
Leiterquerschnitt Cross section area	Max. 0.75 mm ² / min. 0.50 mm ²
Kabeldurchmesser Values for cable clamp	Ø 6 mm ... Ø 8 mm
Temperaturbereich Temperature range	-25 °C ... +85 °C
Steckzyklen Operation cycles	10
Schutzart Degree of protection	IP 20 nach / acc. to IEC EN 60529
Verschmutzungsgrad Degree of pollution	2
Max. Einsatzhöhe über N.N. Max. altitude above sea level	4000 m / 13,120 ft nach / acc. to IEC EN 60664-1
Schrumpfschlauch über Pins 2/4/5 Heat shrink above pins 2/4/5	
Zertifiziert nach Certified according to	VDE-Reg.-No. B687 DIN EN 61984: 2009-11; EN 61984: 2009
Zugelassene Steckerleiste Approved plug connector	BN 126920

Beim Anschluss eines Kabels sind die gültigen Sicherheitsvorschriften zu beachten!
Please attend the valid safety rules for assembling!

Konstruktionsänderungen vorbehalten
Design is subject to change without notice

Diese Zeichnung ist unser Eigentum. Verwendung, Vervielfältigung, Weitergabe der Zeichnungen oder des darin enthaltenen Know-hows an Dritte nur mit unserer ausdrücklichen Genehmigung.

Maßangaben in mm Dimensions in mm		Projektion E: Projection E:		Maßstab: / Scale:	
Allgemeintoleranzen: General tolerances: DIN ISO 2768mH		Datum: Date: 31.01.2011	Name: Name: Frank	Bezeichnung: Title: Kabelkupplung cable socket	
Index: Revision:	Änd.-Nr.: Issue-No.:	Datum: Date:	Name: Name:	5-polig / 5 pole, 250 VAC	
D 01-1077203.12.2013	Hartmann	Erstellt: Creator: 31.01.2011	Frank	Zeichnungs-Nr.: Drawing-No.:	
C 01-0907127.02.2013	Hupfauer	Geprüft: Checked: 12.12.2013	Hartmann	Format: Format: A4	
B DIV_CORP 01.02.2011	Frank	Spinner GmbH Erzgiessereistr. 33 D-80335 München		Blatt: Sheet: 1	
A Startindex 31.01.2011	Frank	126919-0E		von: of: 1	