

3-WAY COMBINER 694-2700 MHZ

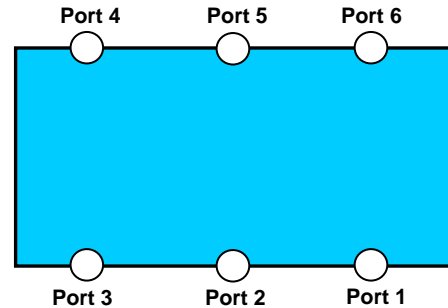

Part number	BN 570633
Connectors	7-16 female (50 Ohms)
Port 1 - 3	Input ports
Port 4 - 6	Output ports
Frequency range	694 - 2700 MHz
Insertion loss	
Port 1, 2, 3 → Port 4	5.0 dB ± 0.8 dB*
Port 1, 2, 3 → Port 5	5.0 dB ± 0.8 dB*
Port 1, 2, 3 → Port 6	5.0 dB ± 0.8 dB* (@790 - 2700MHz) 5.0 dB ± 1.2 dB* (@694 - 790MHz)
*including nominal 4.8dB splitting losses	
Isolation	≥ 30dB typ. 32 dB
VSWR	≤ 1.20
Max. input power per port	500 W
IM-value 3rd order @ 2 x 20W	≤ -160 dBc typ. -165 dBc
Test voltage	500 V
Degree of protection	IP 65 outdoor
Class. of environmental conditions	ETSI EN 300019-1-1 Class 1.2 ETSI EN 300019-1-2 Class 2.3 ETSI EN 300019-1-4 Class 4.1E
Wall / Mast mounting	Part of delivery
Weight	5.0 kg
Operating temperature	-40°C - +70°C

Dimensions:

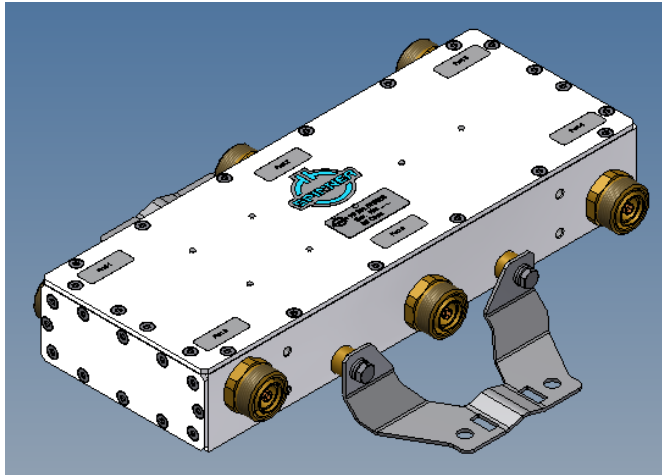
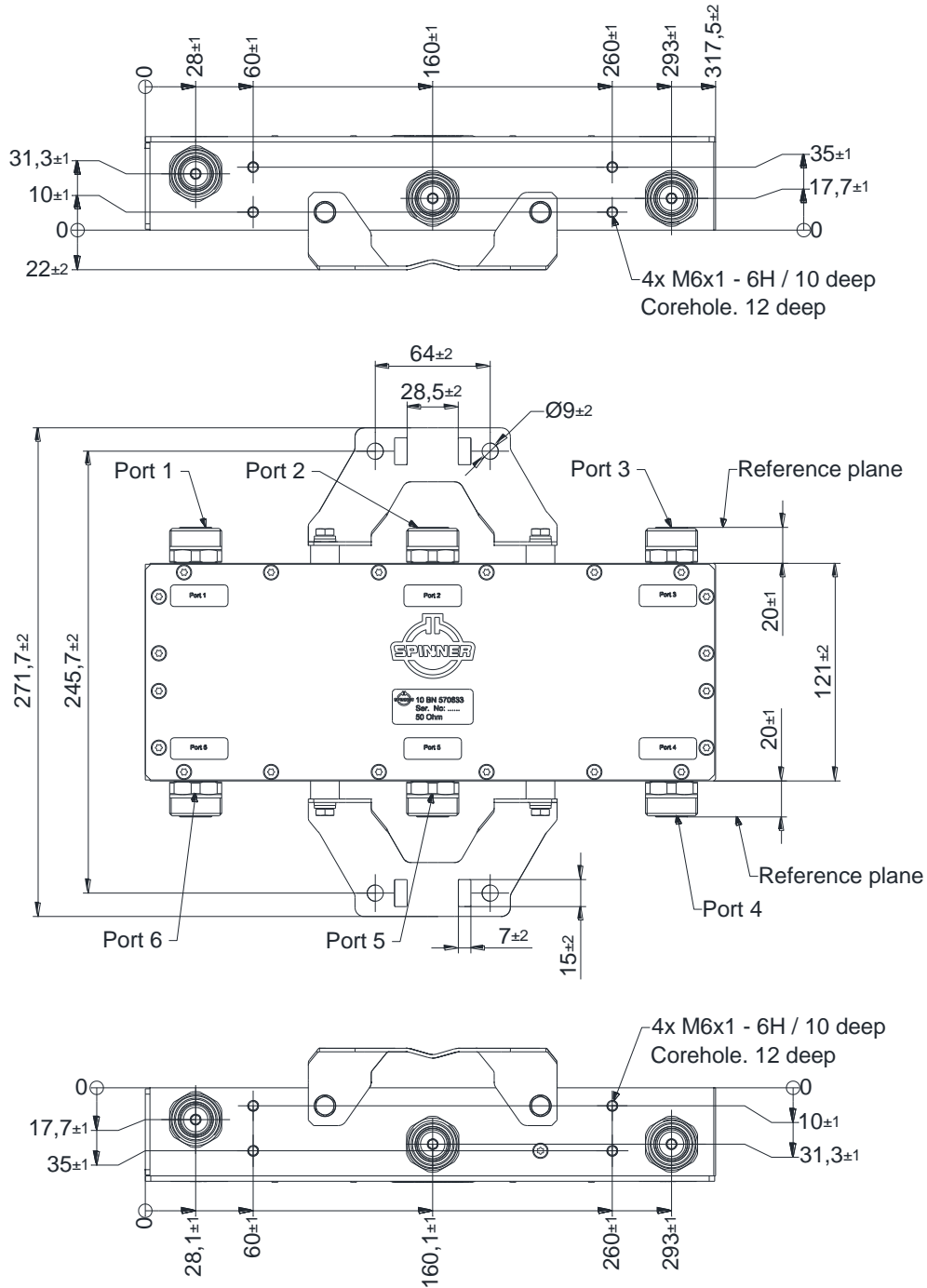

Standard:

7-16 female (50 ohms): CECC 22190, IEC 61169-4

Modification reserved

Measurements:

VSWR:

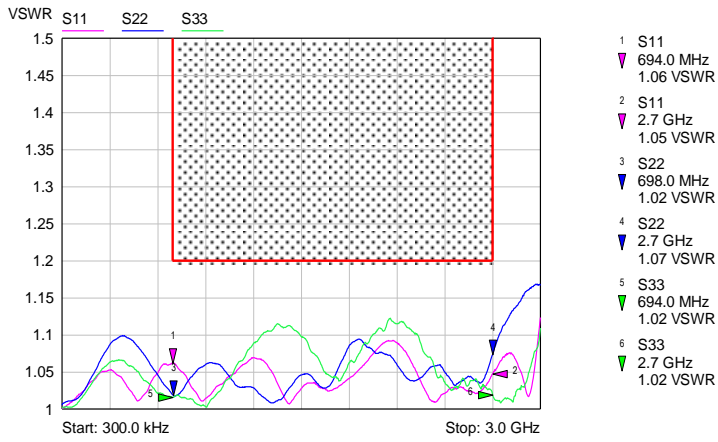

— typical for: S11
 — typical for: S22
 — typical for: S33

Insertion loss:

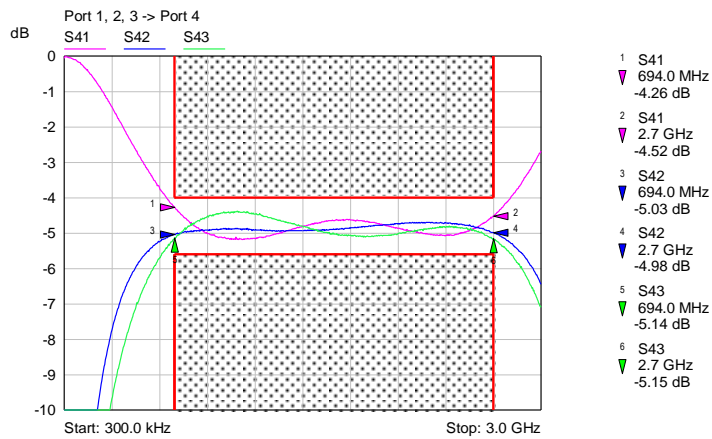

— typical for: S41
 — typical for: S42
 — typical for: S43

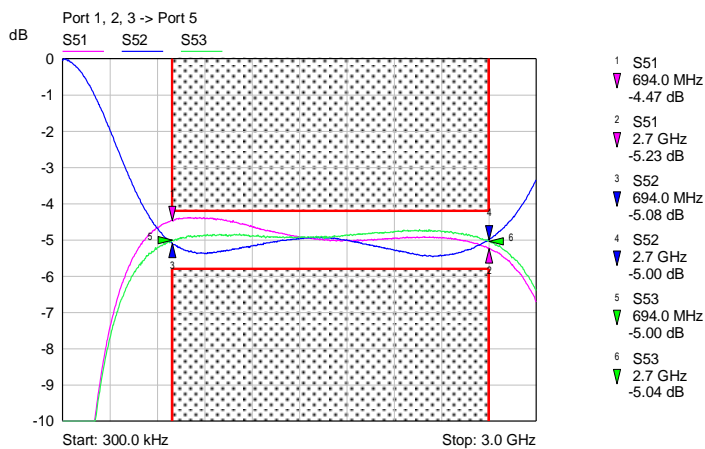

— typical for: S51
 — typical for: S52
 — typical for: S53

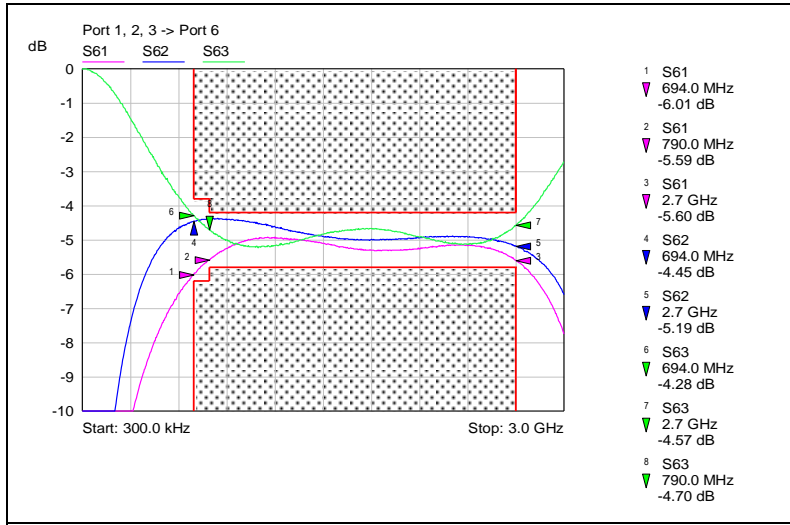

— typical for: S61

— typical for: S62

— typical for: S63

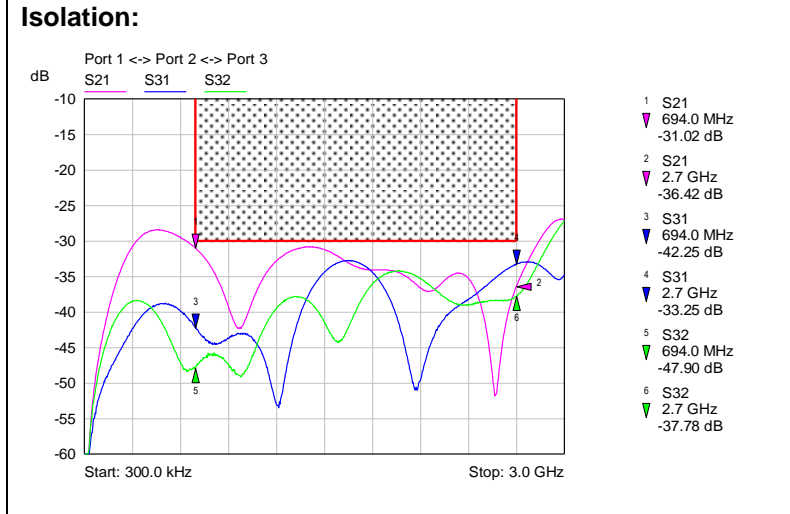

— typical for: S21

— typical for: S31

— typical for: S32