

# MINIATURE MICROSWITCHES - HEAVY DUTY

## 83160

- › Coil spring snap-action mechanism with wiping contacts
- › Ratings up to 16(4) A 250 V~ and 10(4) A 400 V~
- › Version with magnetic blowout for enhanced DC breaking capacity up to 5 A 250 V---
- › Long service life: 200 000 operations at nominal rating and up to 10 millions on light load
- › Contact gap less or greater than 3 mm (micro-disconnection (μ) or full disconnection)
- › Operating temperature -40 °C up to +150 °C
- › cURus and ENEC approved (except 831606 SP3697)
- › Wide choice of actuators: pinned or flexible, stainless steel or plastic



### Main specifications

		Standard 831600	Reduced force 831603	Low force 831604	Wide contact gap 831606	High DC rating 831606 SP3697
<b>Function</b>	<b>Connections</b>					
I (changeover)	W2 (solder)	83160005	83160320	83160420	83160602	83160664
I (changeover)	W3 (QC 6.3x0.8)	83160006	83160301	83160401	83160601	83160679
I (changeover)	W6 (QC 4.8x0.5)	83160045	83160321	83160415	●*	●*
I (changeover)	X1-X2 (PCB straight-rear)	●	●	●	●*	●*
I (changeover)	X3 (PCB front)	83160143	●	●	●*	●*
R (normally closed)	W2 (solder)	83160001	●	●	●	●
R (normally closed)	W3 (QC 6.3x0.8)	83160003	83160319	●	83160621	●
R (normally closed)	W6 (QC 4.8x0.5)	●	●	●	●*	●*
R (normally closed)	X2-X3 (PCB rear-front)	●	●	●	●*	●*
C (normally open)	W2 (solder)	83160002	83160324	●	83160603	●
C (normally open)	W3 (QC 6.3x0.8)	83160004	83160316	83160402	83160622	●
C (normally open)	W6 (QC 4.8x0.5)	83160047	●	●	●*	●*
C (normally open)	X2-X3 (PCB rear-front)	●	●	●	●*	●*
<b>Electrical characteristics</b>						
Rating nominal / 250 V AC (A)		16	10	6	16	16
Rating nominal / 250 V DC (A) **		0.5	0.5	0.4	0.8	5
Rating thermal / 250 V (A)		20	15	10	20	20
Rating ENEC/UL / 250 V AC (A)		16(4) - 8 GP	10(4) - 8 GP	6(2) - 6 GP	16(4) - 10 GP	-
<b>Mechanical characteristics</b>						
Maximum operating force (N)		4	2	1	5	5
Min. Release force (N)		1.5	0.6	0.3	1	1
Maximum total travel force (N)		6.5	3	1.5	7	7
Max. Allowable overtravel force (N)		20	20	20	20	20
Rest position max. (mm)		15.6	15.6	15.6	15.7	15.7
Operating position (mm)		14.8±0.3	14.8±0.3	14.7±0.3	14.6±0.4	14.6±0.4
Maximum differential travel (mm)		0.3	0.4	0.35	0.7	0.7
Min. overtravel CRA (mm)		1.3	1.3	1.3	1	1
Ambient operating temperature (°C)		-40 → +125	-40 → +125	-40 → +125	-40 → +125	-40 → +125
Mechanical life (operations)		10 <sup>7</sup>	10 <sup>7</sup>	10 <sup>7</sup>	10 <sup>6</sup>	10 <sup>6</sup>
Contact gap (mm)		1.2	1.2	1.2	3.2	3.2
Weight (g)		6.7	6.7	6.7	6.7	6.7

\* Please consult us    \*\* with resistive load

### Additional specifications

- Case, Button: PBT GF (UL 94-V0 / GWFI 960 °C)  
PA66 GF (GWFI 960 °C) - 831606 SP3697 case
- Contacts: silver alloy (gold-plated silver alloy : on request)
- Terminals: brass (except W2/X : copper nickel), silver plated common
- Levers: stainless steel or polyamide, polyamide roller
- Degree of protection: IP40 (mechanism)
- Proof tracking index: PTI 250 (PTI 600 on 831606 SP3697)
- Recommended min actuating speed: 0.1 mm/s
- Certification marks: (except 831606 SP3697) /

### Product adaptations



- › Special levers: special shapes and lengths
- › Special connections: angled, screw with clamp (W5), full wiring with custom connector....
- › Telescopic plunger and adjustable fixing by threaded barrel: plastic version (153L accessory) or metal version (SP9603 or 83556, single or double pole)
- › High operating temperature: +150 °C
- › Variant for irradiated environment (SF1320)
- › 400 Vac ENEC/cURus approved versions (SP9654)
- › cURus/ENEC approvals for 831606 SP3697

Standard product

Product made to order

Contact us

Principles

Single break snap-action switch  
Changeover - SPDT (form C)

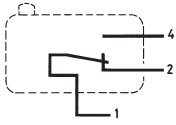

Normally closed - SPST-NC (form B)

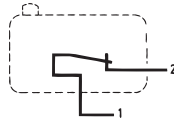

Normally open - SPST-NO (form A)

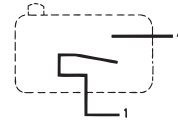

Curves

Operating curve for type 831600

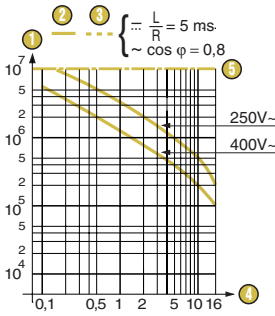

Operating curve for type 831603

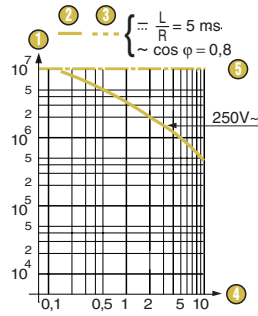

Operating curve for type 831604

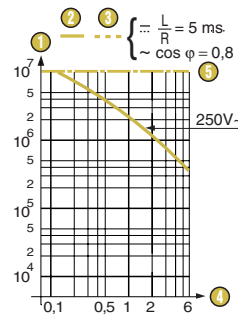

Operating curve for types 831606 and 831606 SP3697

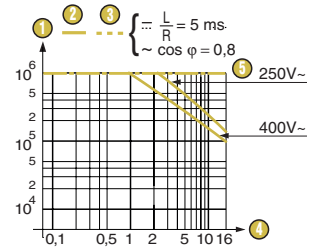

- 1 Number of cycles
- 2 Resistive circuit
- 3 Inductive circuit
- 4 Current in Amps
- 5 Mechanical life limit

- 1 Number of cycles
- 2 Resistive circuit
- 3 Inductive circuit
- 4 Current in Amps
- 5 Mechanical life limit

- 1 Number of cycles
- 2 Resistive circuit
- 3 Inductive circuit
- 4 Current in Amps
- 5 Mechanical life limit

- 1 Number of cycles
- 2 Resistive circuit
- 3 Inductive circuit
- 4 Current in Amps
- 5 Mechanical life limit

DC electrical life for type 831606 SP3697: 250 V~: 5 A resistif 300 000 cycles  
 250 V~: 1,5 A L/R 5 ms 30 000 cycles  
 250 V~: 0,5 A L/R 50 ms 50 000 cycles  
 125 V~: 3 A L/R 5 ms 30 000 cycles

Dimensions

Products

831600 / 3 / 4 / 6

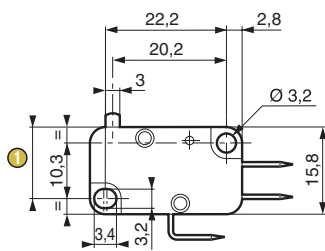

831606 SP3697

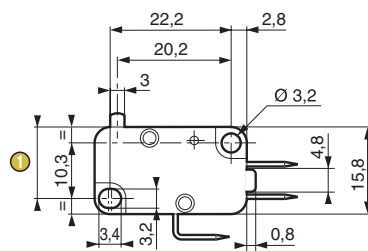

1 Total travel position = 13.2 max.

## Connections

W2 solder

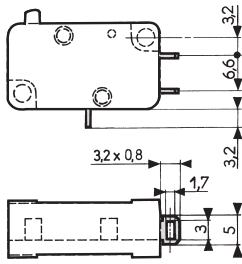

W3 quick-connect 6.3 x 0.8

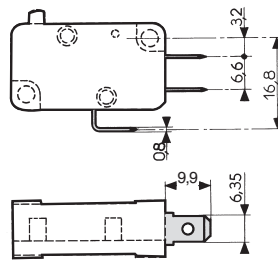

W6 quick-connect 4.8 x 0.5

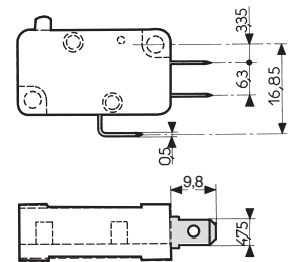

X1 for PCB, straight output

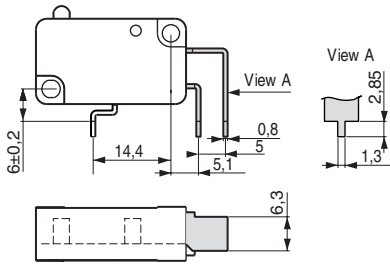

X2 for PCB, rear output

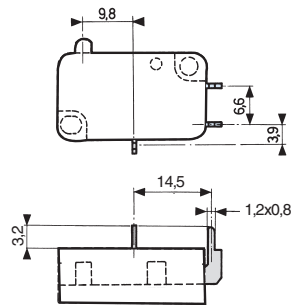

X3 for PCB, front output

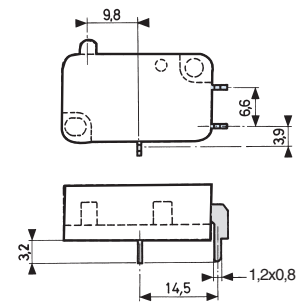

## Actuator mounting position

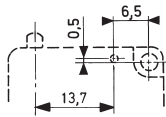

## Actuators

153AX flat

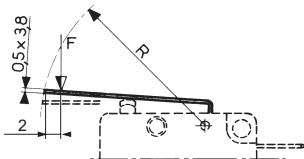

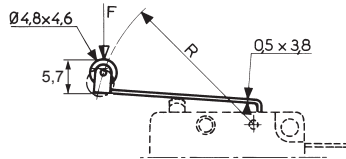

153EX roller



Other shapes and dimensions: consult us

## Actuators and mounting accessories

### Part numbers for standard actuators

		79211671*			79211672*			79211674*		
Actuators		Flat 153AX R29.7			Roller 153EX R15.8			Roller 153 EX R28.7		
										
		<b>831600</b>	<b>831603</b>	<b>831606</b>	<b>831600</b>	<b>831603</b>	<b>831606</b>	<b>831600</b>	<b>831603</b>	<b>831606</b>
Operating position	mm	15.3 <sup>±0.5</sup>	15.3 <sup>±0.5</sup>	14.4 <sup>±0.6</sup>	20.5 <sup>±0.45</sup>	20.5 <sup>±0.45</sup>	20.3 <sup>±0.55</sup>	20.5 <sup>±0.65</sup>	20.5 <sup>±0.65</sup>	19.6 <sup>±0.75</sup>
Operating force - max.	N	2	1	2.6	4	2	5	2	1	2.6
Release force - min.	N	0.4	0.25	0.3	1	0.55	0.75	0.4	0.25	0.3
Pretravel - max.	mm	2.5	2.5	3.1	1.2	1.2	1.4	2.5	2.5	3.1
Differential travel max.	mm	0.6	0.8	1.5	0.3	0.4	0.7	0.6	0.8	1.5
Total travel max.	mm	4.6	4.6	4.6	2.3	2.3	2.3	4.6	4.6	4.6

\*We recommend that levers are mounted in our factories. See preferred part numbers in table below.  
For unmounted supply, please also order associated pin **79210424**.

### Part numbers for standard actuators

Actuators

79211694\*

79211668\*

Two-pole 153A2XB R24\*\*

Dummy roller 153FX R24.3\*\*

Telescopic plunger 153L\*\*

Flexible with roller 153B\*\*

Plastic 153 V\*\*

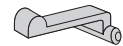
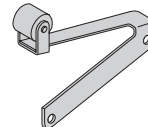
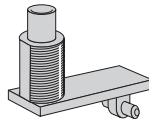
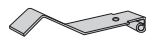
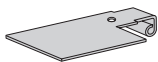

\*\* Please consult us

### 83160 microswitches with referenced actuators

Actuators		153AX R29.7	153EX R15.8	153EX R28.7
		79211671	79211672	79211674
831600	I W2	●	83160134	83160038
	I W3	83160067	83160029	83160065
	I W6	83160115	83160069	●
831603	I W2	83160345	●	●
	I W3	83160347	83160327	83160329
	I W6	●	●	●
831606	I W2	●	●	●
	I W3	●	83160669	83160674
831606 SP3697	I W2	●	83160681	●
	I W3	●	83160680	●

## Installation recommendations

See "Basic technical concepts"

## How to order

Use the 8 digit part numbers when they are defined

Other cases, precise: Type of microswitch - Function - Connection - Actuator\* - Adaptation\*

\* if needed

Example: 831600 I X1 153AX R29.7

Standard product

Product made to order



Contact us

## Examples of special adaptations



Special lever and angled W3 terminals



Full wiring with custom connector



Customised version for nuclear application. Has radiation-resistant housing, 180 °C max operating temperature, W5 screw terminals and magnetic blowout for highly inductive circuit switching at 250 V $\overline{-}$



Telescopic plunger with Ø12 mm adjustable fixing and 4 mm overtravel. Metal version for heavy duty (SP9603)

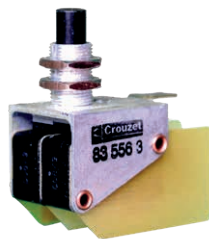

Telescopic plunger with Ø10 mm threaded barrel, metal bracket and plastic button. Single pole or double pole with staggered switchings (83556)

### Warning:

The product information contained in this catalogue is given purely as information and does not constitute a representation, warranty or any form of contractual commitment. Crouzet Automatismes SAS and its subsidiaries reserve the right to modify their products without notice. It is imperative that we should be consulted over any particular use or application of our products and it is the responsibility of the buyer to establish, particularly through all the appropriate tests, that the product is suitable for the use or application. Under no circumstances will our warranty apply, nor shall we be held responsible for any application (such as any modification, addition, deletion, use in conjunction with other electrical or electronic components, circuits or assemblies, or any other unsuitable material or substance) which has not been expressly agreed by us prior to the sale of our products.