

SUBMINIATURE MICROSWITCHES - PREMIUM

V4 - 83170

- › High precision flexible leaf snap-action mechanism
- › Operation without balance-point, even at extremely slow actuating speed
- › Ratings from 1 mA 4 V $\overline{\text{---}}$ up to 12(6) A 250 V \sim and 1/4 hp 125-250 V \sim
- › ENEC and cURus approved up to +150 °C
- › Housing material complying with IEC 60335-1 for unattended appliances:
GWFI 850° C / GWIT 775° C
- › Mechanical life up to 30 million cycles
- › High resistance to shock and vibration
- › Choice of connections with symmetric and asymmetric pinning
- › Wide choice of actuators on 2 possible fixing positions
(pre-assembled or retrofittable)







Main specifications

		Standard 831700	Low force 831704	Dual-current 831708	Dual-current Low force 831709
Function	Connections				
I (changeover)	W2 (solder)	83170002	83170402	83170802	83170902
I (changeover)	W7A5 (QC 2.8x0.5)	83170005	83170405	83170805	83170905
I (changeover)	X1 (PCB, straight)	83170008	83170408	83170808	83170908
I (changeover)	X1S (PCB, straight, sym)	83170009	83170409	83170809	83170909
I (changeover)	X2 (PCB, rear)	83170010	83170410	83170810	83170910
I (changeover)	X2S (PCB, rear, sym)	83170011	83170411	83170811	83170911
I (changeover)	X3 (PCB, front)	83170012	83170412	83170812	83170912
I (changeover)	X3S (PCB, front, sym)	83170013	83170413	83170813	83170913
R (normally closed)	W2 (solder)	83170003	83170403	83170803	83170903
R (normally closed)	W7A5 (QC 2.8x0.5)	83170006	83170406	83170806	83170906
C (normally open)	W2 (solder)	83170004	83170404	83170804	83170904
C (normally open)	W7A5 (QC 2.8x0.5)	83170007	83170407	83170807	83170907
Electrical characteristics					
Rating nominal / 250 V AC (A)		10	5	5**	5**
Rating thermal / 250 V AC (A)		12.5	6	6	6
Rating ENEC/UL / 250 V AC (A)		10(2) - 3(3) - 10 GP	5(1) - 5 GP	5(1) - 1 GP	5(1) - 1 GP
Mechanical characteristics					
Maximum operating force (N)		1.5	0.6	1.5	0.6
Min. Release force (N)		0.3	0.1	0.3	0.1
Maximum total travel force (N)		1.8	1	1.8	1
Max. allowable overtravel force (N)		10	10	10	10
Rest position max. (mm)		9.2	9.2	9.2	9.2
Operating position (mm)		8.4 \pm 0.3	8.4 \pm 0.3	8.4 \pm 0.3	8.4 \pm 0.3
Maximum differential travel (mm)		0.15	0.15	0.15	0.15
Min. overtravel (mm)		0.5	0.5	0.5	0.5
Ambient operating temperature (°C)		-40 \rightarrow +125	-40 \rightarrow +125	-40 \rightarrow +125	-40 \rightarrow +125
Mechanical life (operations)		10 ⁷	3.10 ⁷	10 ⁷	3.10 ⁷
Contact gap (mm)		0.35	0.35	0.35	0.35
Weight (g)		1.7	1.7	1.7	1.7

Additional specifications

- Case: PA66 GF (UL 94-V0 / GWFI 960 °C / GWIT 775 °C)
- Button: PA66 GF
- Moving blade: beryllium copper
- Contacts: silver alloy, micro-profile
gold alloy on silver alloy, crossbar (dual-current)
- Terminals: copper nickel (except W7A5: brass)
- Levers: stainless steel or plastic, polyamide roller

- Degree of protection: IP40 (mechanism)
- Proof tracking index: PTI 400
- Protection against electric shock: button and actuators have reinforced insulation for U_i 250 V / U_{imp} 2,5kV / pollution 2
- Recommended min actuating speed: 0.001 mm/s
- Conformity / Certifications:     

Product adaptations



- › Special actuators: stainless steel or plastic, special shapes and lengths, stainless steel roller, ...
- › Special connections: angled, screw, double tabs, ...
- › Special fastening pins
- › High operating temperature: +150 °C
- › 12(6) A 250 Vac ENEC and cURus approved version (831700 SP9765)
- › AgSnO₂ contacts for very high inrush currents (lamp and capacitor loads)
- › Increased or reduced differential travel (SP4982: max 0.08 mm)
- › Specific operating force up to 2.2 N
- › Telescopic plunger with 3 mm overtravel and adjustable fixing by threaded barrel
- › NC contacts with forced break action to prevent contact welding in case of accidental overcurrents

Standard product

Product made to order



Contact us

Principles

Single break snap-action switch
Changeover - SPDT (form C)

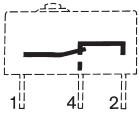

Normally closed - SPST-NC (form B)

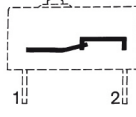

Normally open - SPST-NO (form A)

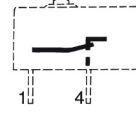

Curves

Operating curve for type 831700

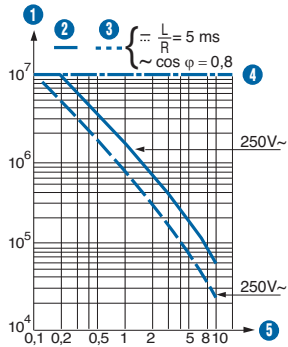

- 1 Number of cycles
- 2 Resistive circuit
- 3 Inductive circuit
- 4 Mechanical life limit
- 5 Current in Amps

Operating curve for type 831704

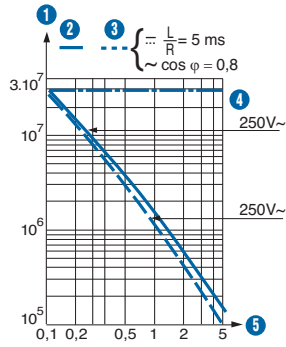

- 1 Number of cycles
- 2 Resistive circuit
- 3 Inductive circuit
- 4 Mechanical life limit
- 5 Current in Amps

Operating curve for types 831708/831709

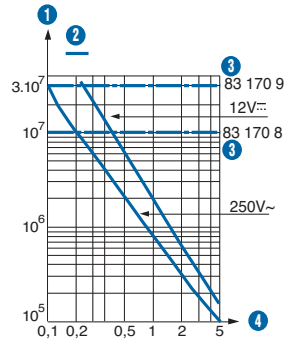

- 1 Number of cycles
- 2 Resistive circuit
- 3 Mechanical life limit
- 4 Current in Amps

** Models 831708 and 831709 are designed to operate equally well on low-current (1 mA 4 V minimum recommended) or medium-current (5 A maximum) circuits. However, a given product should only be used to switch one type of circuit during its working life.

Dimensions

Products

83170
Asymmetrical version

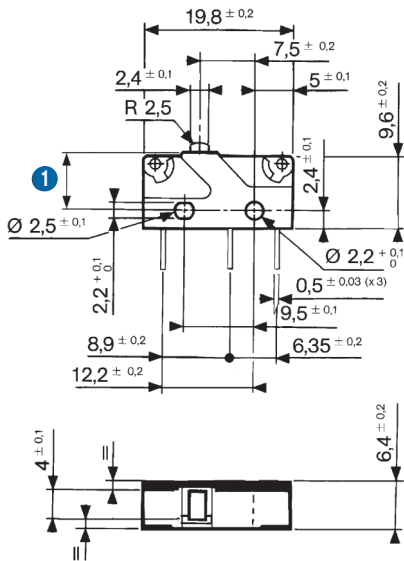

1 Total travel position = max 7.6

Fixing with M2 screws
Recommended tightening torque: 0.2 N.m

83170
Symmetrical version (X.S connections)

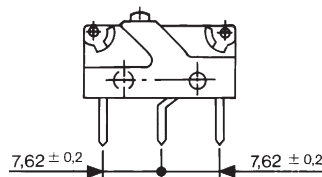

Connections

W2 solder

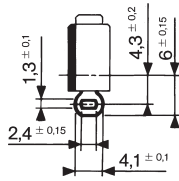

X2 - X2S for PCB, rear output

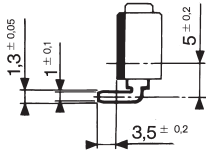

W7A5 quick-connect 2.8 x 0.5

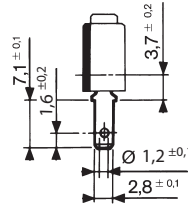

X1 - X1S for PCB, straight output

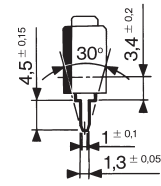

X3 - X3S for PCB, front output

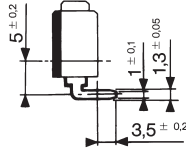

Drilling

Printed circuit board mounting Asymmetrical X1 - X2 - X3

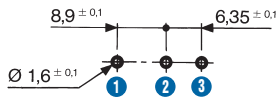

- 1 1.C
- 2 4.NO
- 3 2.NC

Printed circuit board mounting Symmetrical X1S - X2S - X3S

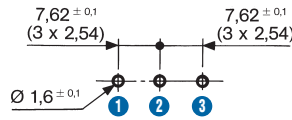

- 1 1.C
- 2 4.NO
- 3 2.NC

Mounting on a printed circuit board with holding pins Asymmetrical X2 - X3

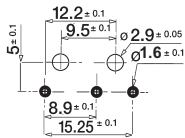

Mounting on a printed circuit board with holding pins Symmetrical X2S - X3S

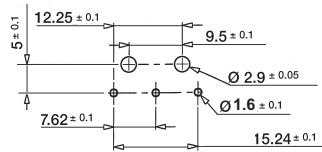

Mounting accessories

Locating pins 79219682

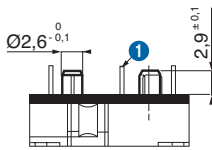

- 1 X2 - X2S connections

Locating pins 79219682

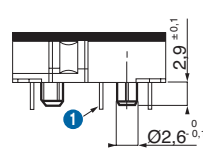

- 1 X3 - X3S connections

Other shapes and dimensions:
consult us

Actuator mounting positions

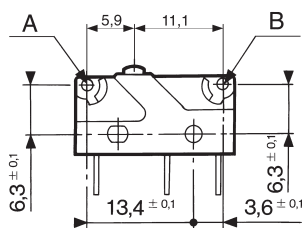

To calculate force : divide the switch force by the coefficient in the table.
To calculate travel : multiply the switch travel by the same coefficient.

Actuators

170A flat

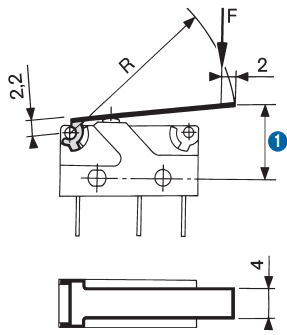

1 Operating position

170D adjustable

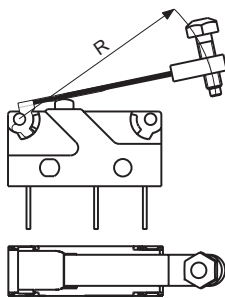

79257876 plastic

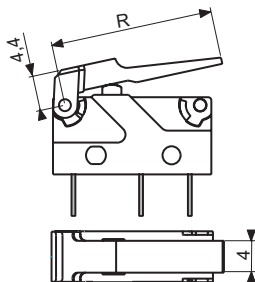

170E roller

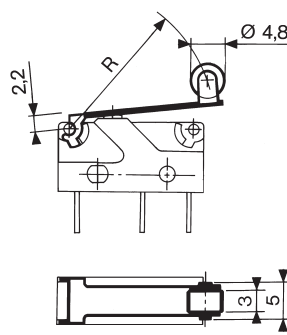

170EL transverse roller

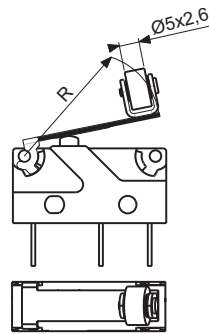

Other shapes and dimensions:
consult us

170F dummy roller

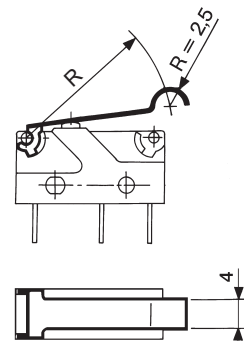

79250004 folded

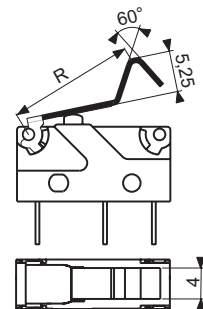

Actuators and mounting accessories

Part numbers for standard actuators	79253327	79253326	79253328	79218454	79253329
Actuators	Flat 170A R18,3	Flat 170A R24	Flat 170A R41	Roller 170E R20	Dummy roller 170F R19,5
Fixing positions	A B	A B	A B	A B	A B
Coefficient	3 1.5	4 2	7 3.5	3 1.5	3 1.5
Operating position (mm)	10 ±1 9.4 ±0.6	10.8 ±1.4 9.8 ±0.8	12.1 ±2.6 10.5 ±1.5	14.7 ±1.3 14.2 ±0.8	12.6 ±1.2 11.9 ±0.7
Part numbers for standard actuators	79218491	79218493	79250004	79257876	
Actuators	Adjustable 170D R26,5	Transverse roller 170EL R18	Folded R16,5	Plastic (PARA GF50) R20,5	
Fixing positions	A B	A B	A B	A B	
Coefficient	4 2	3 1.5	2.5 1.2	3 -	
Operating position (mm)	13.6-18.6 ±1.8 12.5-17.5 ±1.1	16.3 ±1.2 15.6 ±0.8	15 ±1 13.9 ±0.6	10.6 ±1.1 -	

Except where otherwise indicated, levers are supplied unmounted. For factory mounting, specify fixing position A or B.

V4 - 83170 microswitches with referenced actuators

Actuators	170A R18.3 79253327		170A R24 79253326		170E R20 79218454		170F R19.5 79253329		Folded R16,5 79250004		Plastic 79257876
	Pos A	Pos B	Pos A	Pos B	Pos A	Pos B	Pos A	Pos B	Pos A	Pos B	Pos A
831700	I W2	83170162	83170185	83170182	•	•	•	83170028	83170032	•	83170176
	I W7A5	83170197	83170037	•	•	•	83170046	83170183	•	•	
	I X1	•	•	•	•	83170121	83170049	83171014	83170184	•	•
	I X1S	•	•	•	•	•	•	•	•	•	•
	I X2	•	83170160	•	•	•	•	83170038	•	83170035	•
I X3	•	83170161	•	•	•	•	83170039	•	83170036	•	
831704	I W2	83170437	83170439	83170440	83170441	83170434	83170442	83170443	83170444	•	•
	I W7A5	83170445	83170446	83170447	83170448	83170449	83170450	83170451	83170433	•	•
	I X1	83170464	83170465	83170466	83170467	83170468	83170469	83170470	83170471	•	•
	I X1S	•	•	•	•	83170435	•	•	•	•	•
	I X2	•	•	•	•	•	•	•	•	83170427	•
I X3	•	•	•	•	•	•	•	•	83170428	•	
831708	I W2	83170848	•	83170832	•	83170865	•	•	•	83170833	•
	I W7A5	•	83170849	83170869	•	•	•	•	•	•	83170864
	I X1	•	•	•	•	•	•	83170850	83170851	•	•
	I X1S	•	•	•	•	•	•	•	•	•	•
	I X2	•	•	•	•	•	•	•	•	•	•
I X3	•	•	•	•	•	•	•	•	•	•	
831709	I W2	83170930	83170931	83170932	83170933	83170934	83170935	83170936	83170937	•	•
	I W7A5	83170938	83170939	83170929	83170940	83170941	83170942	83170943	83170944	•	•
	I X1	83170928	83170945	83170946	83170947	83170948	83170949	83170950	83170951	•	•
	I X1S	83170926	83170927	•	•	•	•	•	•	•	•
	I X2	•	•	•	•	•	•	•	•	•	•
I X3	•	•	•	•	•	•	•	•	•	•	

Installation recommendations

See "Basic technical concepts"

How to order

Use the 8 digit part numbers when they are defined

Other cases, precise: Type of microswitch - Function - Connection - Actuator* - Fixing position* - Mounting accessories* - Adaptation*
* if needed

Example: 831708 I X2 170A R24 B 79219682

Examples of special adaptations



Angled W7A5 terminals

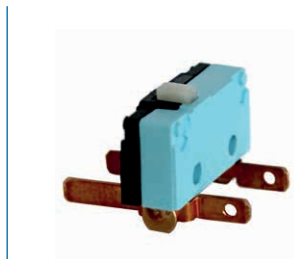

Double lateral 2.8 x 0.5 quick-connect terminals



Top mounted bracket and screw terminals



Telescopic plunger with 3 mm overtravel and with M6 x 0.75 threaded barrel



Two-pole assembly with single actuator



Fastening pins for 2.8 max thickness and Ø4mm holes (79253576)

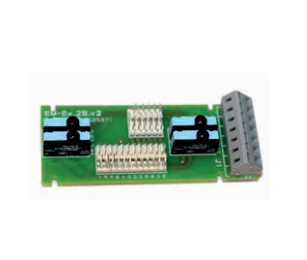

PCB assembly with terminal block



Special buttons: see "V4 Mushroom-head button - 83170 BC"

Standard product Product made to order Contact us

Warning:

The product information contained in this catalogue is given purely as information and does not constitute a representation, warranty or any form of contractual commitment. Crouzet and its subsidiaries reserve the right to modify their products without notice. It is imperative that we should be consulted over any particular use or application of our products and it is the responsibility of the buyer to establish, particularly through all the appropriate tests, that the product is suitable for the use or application. Under no circumstances will our warranty apply, nor shall we be held responsible for any application (such as any modification, addition, deletion, use in conjunction with other electrical or electronic components, circuits or assemblies, or any other unsuitable material or substance) which has not been expressly agreed by us prior to the sale of our products.

SUBMINIATURE MICROSWITCHES - PREMIUM

V4 Mushroom-head button - 83170 BC

- › High precision flexible leaf snap-action mechanism
- › Suitable for lateral approach from any direction with angle up to 45°
- › Operation without balance-point, even at extremely slow actuating speed
- › Ratings from 1 mA 4 V \sim up to 12(6) A 250 V \sim and 1/4 hp 125-250 V \sim
- › ENEC and cURus approved up to +150 °C
- › Housing material complying with IEC 60335-1 for unattended appliances: GWFI 850° C / GWIT 775° C
- › Mechanical life 1 million cycles
- › High resistance to shock and vibration
- › Choice of connections with symmetric and asymmetric pinning



Main specifications

		Standard 831700 BC	Low force 831704 BC	Dual-current 831708 BC	Dual-current Low force 831709 BC
Function	Connections				
I (changeover)	W2 (solder)	83170107	83170473	●	83170965
I (changeover)	W7A5 (QC 2.8x0.5)	●	83170474	●	83170964
I (changeover)	X1 (PCB, straight)	83171006	●	83170840	83170971
I (changeover)	X1S (PCB, straight, sym)	●	83170481	●	●
I (changeover)	X2 (PCB, rear)	●	●	83170836	83170919
I (changeover)	X2S (PCB, rear, sym)	●	83170438	●	●
I (changeover)	X3 (PCB, front)	●	●	●	●
I (changeover)	X3S (PCB, front, sym)	●	83170486	83170874	●
R (normally closed)	W2 (solder)	●	83170495	●	●
R (normally closed)	W7A5 (QC 2.8x0.5)	●	●	●	●
C (normally open)	W2 (solder)	●	●	●	●
C (normally open)	W7A5 (QC 2.8x0.5)	83170114	83170475	●	●
Electrical characteristics					
Rating nominal / 250 V AC (A)		10	5	5**	5**
Rating thermal / 250 V AC (A)		12.5	6	6	6
Rating ENEC/UL/ 250 V AC (A)		10(2) - 3(3) - 10 GP	5(1) - 5 GP	5(1) - 1 GP	5(1) - 1 GP
Mechanical characteristics					
Maximum operating force (N)		1.5	0.6	1.5	0.6
Min. Release force (N)		0.3	0.1	0.3	0.1
Maximum total travel force (N)		1.8	1	1.8	1
Max. allowable overtravel force (N)		10	10	10	10
Rest position max. (mm)		10.8	10.8	10.8	10.8
Operating position (mm)		9.9±0.3	9.9±0.3	9.9±0.3	9.9±0.3
Maximum differential travel (mm)		0.15	0.15	0.15	0.15
Min. overtravel (mm)		0.5	0.5	0.5	0.5
Ambient operating temperature (°C)		-40 +125	-40 +125	-40 +125	-40 +125
Mechanical life at 45° (operations)		10 ⁶	10 ⁶	10 ⁶	10 ⁶
Contact gap (mm)		0.35	0.35	0.35	0.35
Weight (g)		1.7	1.7	1.7	1.7

Additional specifications

- Case: PA66 GF (UL 94-V0 / GWFI 960 °C / GWIT 775 °C)
- Button: PA66 GF
- Moving blade: beryllium copper
- Contacts: silver alloy, micro-profile
gold alloy on silver alloy, crossbar (dual-current)
- Terminals: copper nickel (except W7A5: brass)

- Degree of protection: IP40 (mechanism)
- Proof tracking index: PTI 400
- Protection against electric shock: button has reinforced insulation for Ui 250V / Uimp 2,5kV / pollution 2
- Recommended min actuating speed: 0.001 mm/s
- Conformity / Certifications: cULus CE ENEC CE

Product adaptations



- › Special buttons: cylindrical radius, specific width and height
- › Special connections: angled, screw, double tabs ...
- › Special fastening pins
- › High operating temperature: +150 °C
- › 12 A 250 V \sim version
- › AgSnO2 contacts for very high inrush currents (lamp and capacitor loads)
- › Increased or reduced differential travel (eg: max. 0.08 mm)
- › Specific operating force up to 2.2 N

Standard product

Product made to order



Contact us

Principles

Single break snap-action switch
Changeover - SPDT (form C)

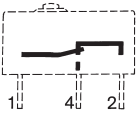

Normally closed - SPST-NC (form B)

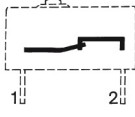

Normally open - SPST-NO (form A)

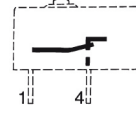

Curves

Operating curve for type
831700 BC

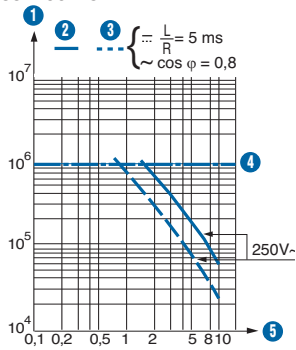

- 1 Number of cycles
- 2 Resistive circuit
- 3 Inductive circuit
- 4 Mechanical life limit
- 5 Current in Amps

Operating curve for type
831704 BC

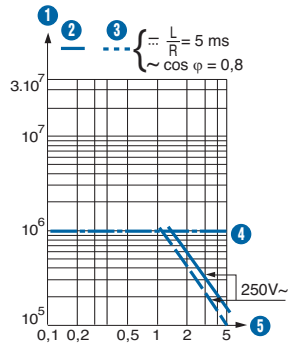

- 1 Number of cycles
- 2 Resistive circuit
- 3 Inductive circuit
- 4 Mechanical life limit
- 5 Current in Amps

Operating curve for types
831708 BC/831709 BC

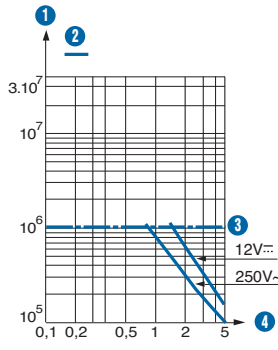

- 1 Number of cycles
- 2 Resistive circuit
- 3 Mechanical life limit
- 4 Current in Amps

**Models 831708 BC and 831709 BC are designed to operate equally well on low-current (1 mA 4 V minimum recommended) or medium-current (5 A maximum) circuits. However, a given product should only be used to switch one type of circuit during its working life.

Dimensions

Products

83170 BC
Asymmetrical version

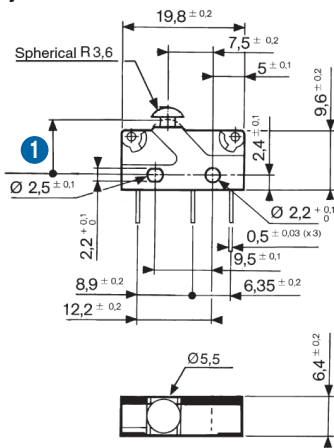

1 Total travel position: max 9.1

Fixing with M2 screws
Recommended tightening torque: 0.2 N.m

83170 BC
Symmetrical version (X.S connections)

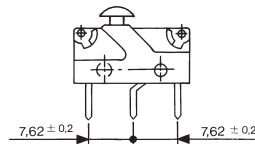

Recommendations for lateral approach

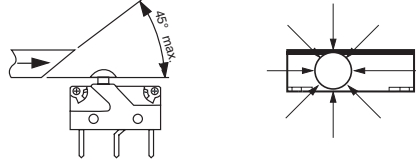

In order to reduce friction and wear, the actuating ramp shall preferably be of POM, PA, PBT or steel, and also be as smooth as possible.

As a general rule, the use of any lubricant substance is not needed nor recommended. For particular cases, please consult us.

Connections

W2 solder

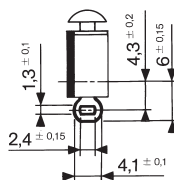

W7A5 quick-connect 2.8 x 0.5

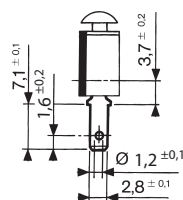

X1 - X1S for PCB, straight output

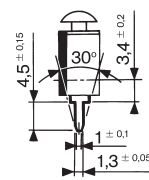

X2 - X2S for PCB, rear output

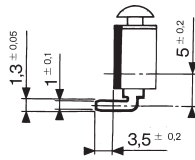

X3 - X3S for PCB, front output

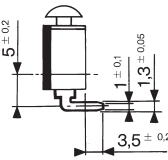

Drilling

**Printed circuit board mounting
Asymmetrical X1 - X2 - X3**

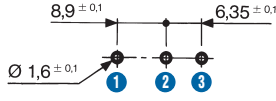

- 1 1.C
- 2 4.NO
- 3 2.NC

**Printed circuit board mounting
Symmetrical X1S - X2S - X3S**

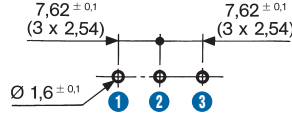

- 1 1.C
- 2 4.NO
- 3 2.NC

**Mounting on a printed circuit board
with holding pins
Asymmetrical X2 - X3**

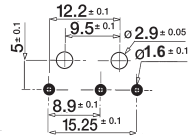

**Mounting on a printed circuit board
with holding pins
Symmetrical X2S - X3S**

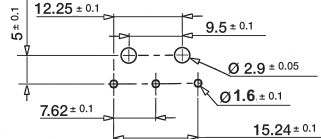

Mounting accessories

Locating pins 79219682

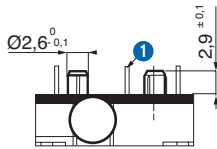

- 1 X2 - X2S connections

Locating pins 79219682

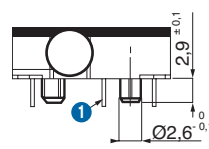

- 1 X3 - X3S connections

Installation recommendations

See "Basic technical concepts"

How to order

Use the 8 digit part numbers when they are defined

Other cases, precise: Type of microswitch - Function - Connection - Mounting accessories* - Adaptation*

* if needed

Example: 831700 BC | X3 79219682

Examples of special adaptations



Angled W7A5 terminals



Button head with cylindrical radius - 4 mm width



Button head with cylindrical radius - 5.5 mm width



Fastening pins for 2.8 max thickness and Ø 4mm holes (79253576)



PCB assembly with terminal block

Warning:

The product information contained in this catalogue is given purely as information and does not constitute a representation, warranty or any form of contractual commitment. Crouzet and its subsidiaries reserve the right to modify their products without notice. It is imperative that we should be consulted over any particular use or application of our products and it is the responsibility of the buyer to establish, particularly through all the appropriate tests, that the product is suitable for the use or application. Under no circumstances will our warranty apply, nor shall we be held responsible for any application (such as any modification, addition, deletion, use in conjunction with other electrical or electronic components, circuits or assemblies, or any other unsuitable material or substance) which has not been expressly agreed by us prior to the sale of our products.