

24 VDC / 24 VAC / 48 VAC / 120 VAC / 220 VAC EIH Part number 84871033

- Current transformer fitted by passing a cable through the front
- AC current threshold adjustable from 1 to 20 A AC (30 Hz to 400 Hz) via button on front
- Relay output 5 A - 250 V AC - 1 N/O contact
- Multivoltage power supply : 100 to 230 V AC 50-60 Hz
24 V AC / DC

Part numbers

Type	Measurement range	Supply voltage
84871 033 EIH	0,1 →10 A	120 V AC

Specifications
Supply

Supply voltage Un	24 VDC / 24 VAC / 48 VAC / 120 VAC / 220 VAC
Voltage supply tolerance	-15 % / +15 % limited to -15 % / +10 % if products are mounted without space between them
Operating range	0.85 →1.15 Un
Power consumption at Un	3 VA AC 1 W DC
Immunity from micro power cuts	10 ms

Inputs and measuring circuit

Frequency of measured signal	40 →500 Hz
Threshold adjustment	10 →100 % of the measurement range
Adjustable hysteresis	5 →50 % of the displayed threshold
Display precision	± 10 %
Repetition accuracy with constant parameters	± 0.1 %
Measuring error with voltage drift	± 0.1 % (± 10 % Un)
Measuring error with temperature drift	± 0,02 %

Timing

Delays on power up (Ti)	0.1 s →20 s ± 10 %
Delay on threshold crossing Tt	0.1 s →3 s ± 10 %
Repetition accuracy with constant parameters	± 0.1 %
Reset time	500 ms
Delay on pick-up	500 ms

Output

Type of output	1 changeover AgNi, 8A AC max
Type of contacts	No cadmium
Maximum breaking voltage	250 V AC/DC
Max. breaking current	8 AAC max.
Min. breaking current	100 mA AC/DC
Electrical life (number of operations)	AC 12 : 2000 VA - 10 ⁵ AC 15 : Cos φ = 0,3 - 6 000 DC 13 : L/R = 300 ms - 6 000
Breaking capacity (V resistive)	2000 VA AC
Maximum rate	360 operations/hour at full load
Operating categories acc. to IEC/EN 60947-5-1	AC12, AC15, DC13
Mechanical life (operations)	5 x 10 ⁶

Insulation

Insulation coordination (IEC/EN 60664-1)	Overvoltage category III : degree of pollution 2
Rated impulse withstand voltage (IEC/EN 60664-1)	4 KV (1,2 / 50 μs)
Dielectric strength (IEC/EN 60664-1)	2,5 KV AC 50 Hz 1 min.
Insulation resistance (IEC/EN 60664-1)	> 100 MΩ / 500 VDC

General characteristics

Display power supply	Green LED
Display relay	Yellow LED
Casing	22,5 mm
Mounting	On 35 mm symmetrical DIN rail, IEC/EN 60715
Mounting position	All positions
Material : enclosure plastic type VO to UL94 standard	Enclosure plastic type VO to UL94 standard
Protection (IEC/EN 60529)	Terminal block : IP 20 Casing : IP 50
Weight	140 g
Connecting capacity IEC/EN 60947-1	Rigid : 1 x 4 ² - 2 x 2.5 ² mm ²

	1 x 11 AWG - 2 x 14 AWG Flexible with ferrules : 1 x 2,5 ² - 2 x 1,5 ² mm ² 1 x 14 AWG - 2 x 16 AWG
Max. tightening torques IEC/EN 60947-1	0,6 mN / 5,3 Lbf.In
Operating temperature IEC/EN 60068-2	-20 → +50
Storage temperature IEC/EN 60068-2	-30 → +70
Humidity IEC/EN 60068-2-30	93 % RH max. without condensation
Vibrations according to IEC/EN60068-2-6	10 → 55 Hz, A = 0,35 mm

Standards

Product standard	IEC/EN 60255-1
Electromagnetic compatibility (EMC)	IEC/EN 61000-6-1, IEC/EN 61000-6-1, IEC/EN 61000-6-3, IEC/EN 61000-6-4
Certifications	UL, CSA
Marking	CE (DBT) 2006/95/EC - EMC 2004/108/EC
Conformity with environmental directives	RoHS

Inputs and measuring circuit

Type	Shunt
Polarity with DC voltage	Yes
AC supply voltage frequency	50 / 60 Hz
Galvanic isolation of power supply/measurement	DC : no galvanic isolation. In this case, the product power supply and measuring circuit power supply must be electrically isolated AC : galvanic isolation by transformer
Measurement range	0,1 → 10 A E1-M : 0,1 → 1 A E2-M : 0,5 → 5 A E3-M : 1 → 10 A
Input resistance	E1-M : 0.1 Ω E2-M : 0.02 Ω E3-M : 0.01 Ω
Permanent overload at 25 °C	E1-M : 2 A E2-M : 10 A E3-M : 14 A
Pulse overload < 1 sec at 25 °C	E1-M : 17 A E2-M : 20 A E3-M : 50 A
Maximum voltage	Network 277 V / 480 VAC

Principles

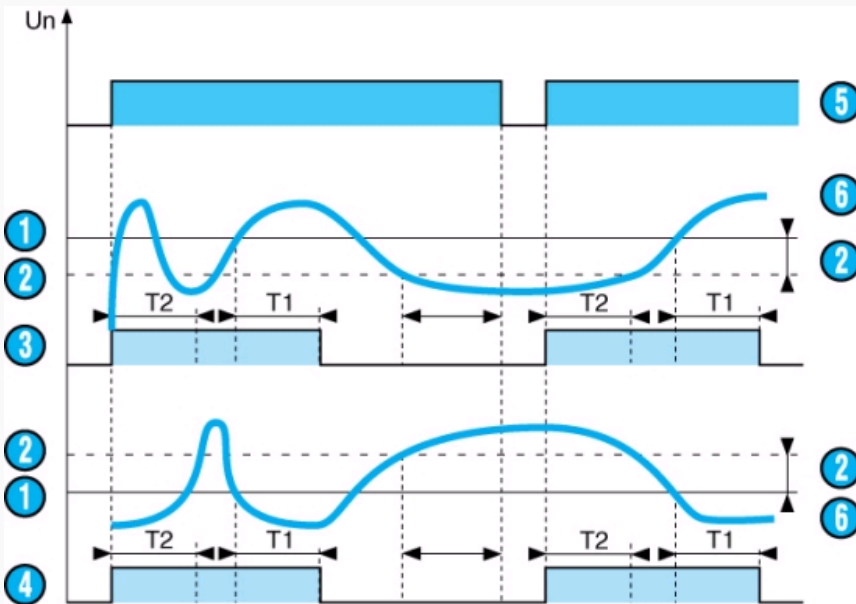

Operating principle

AC/DC control without memory

When the value of the controlled current, either AC or DC, reaches the threshold displayed on the front face, the output relay changes state at the end of time delay T1. It returns instantly to the initial state when the current drops below the hysteresis threshold, or when the power supply is disconnected.

AC/DC control with memory

The output relay changes state at the end of time delay T1 and remains latched in this position. To reset the memory function the auxiliary supply must be disconnected.

Over-current function (UPPER)

The time delay on energisation T2 prevents current peaks due to motor starting.

The delay on upward crossing of threshold T1 provides immunity to transients and other interference, thereby preventing spurious triggering of the output relay.

Under-current function (UNDER)

The time delay on energisation T2 prevents the occurrence of current troughs. The delay on downward crossing of threshold T1 provides immunity to random dips, thereby preventing spurious triggering of the output relay.

Note : In underload function, the absolute value of the hysteresis cannot be greater than the measurement range maximum.

N°	Legend
①	Threshold
②	Hysteresis
③	UPPER function
④	UNDER function
⑤	Unit power-up
⑥	Controlled current

Principles

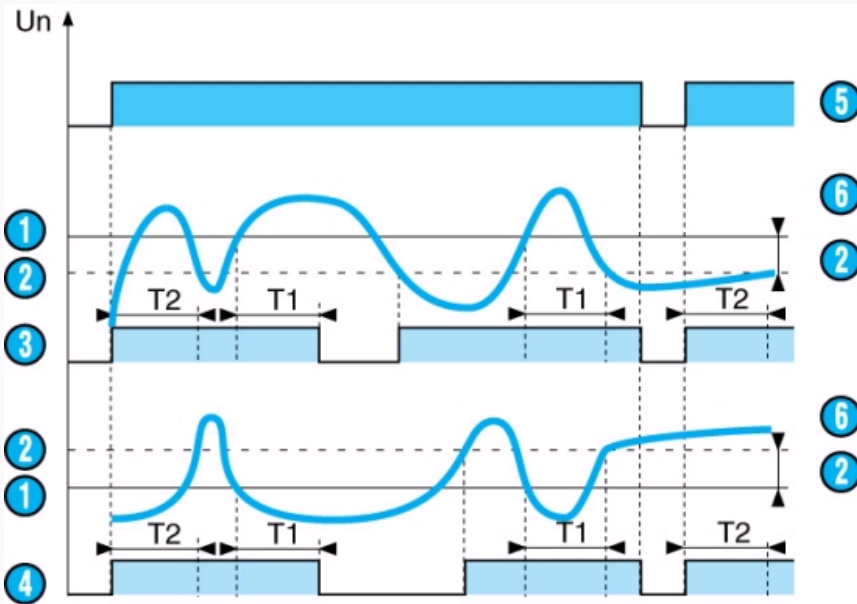

Operating principle

AC/DC control without memory

When the value of the controlled current, either AC or DC, reaches the threshold displayed on the front face, the output relay changes state at the end of time delay T1. It returns instantly to the initial state when the current drops below the hysteresis threshold, or when the power supply is disconnected.

AC/DC control with memory

The output relay changes state at the end of time delay T1 and remains latched in this position. To reset the memory function the auxiliary supply must be disconnected.

Over-current function (UPPER)

The time delay on energisation T2 prevents current peaks due to motor starting. The delay on upward crossing of threshold T1 provides immunity to transients and other interference, thereby preventing spurious triggering of the output relay.

Under-current function (UNDER)

The time delay on energisation T2 prevents the occurrence of current troughs. The delay on downward crossing of threshold T1 provides immunity to random dips, thereby preventing spurious triggering of the output relay.

Note : In underload function, the absolute value of the hysteresis cannot be greater than the measurement range maximum.

N°	Legend
①	Threshold
②	Hysteresis
③	UPPER function
④	UNDER function
⑤	Unit power-up
⑥	Controlled current

Dimensions (mm)

EIL / EIH / EIT

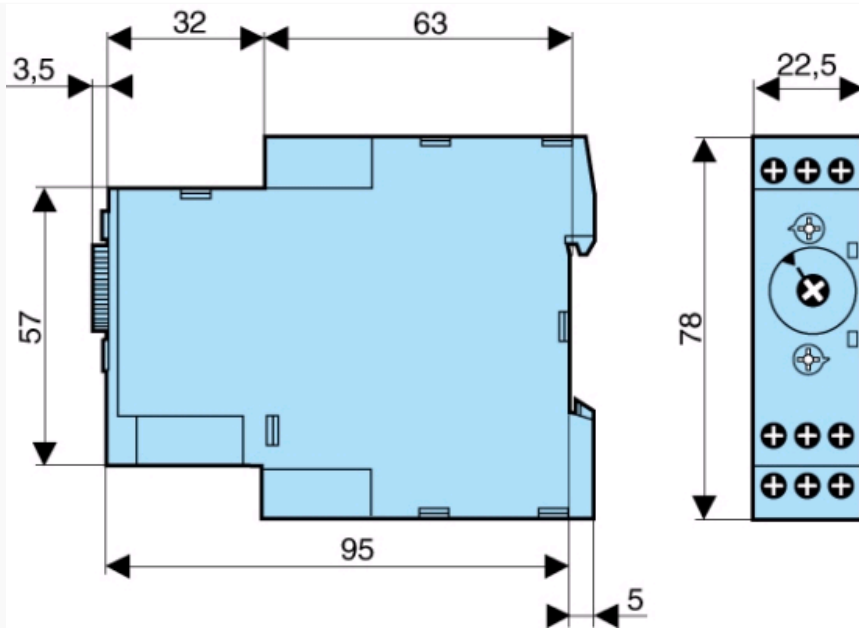

Connections

EIL / EIH

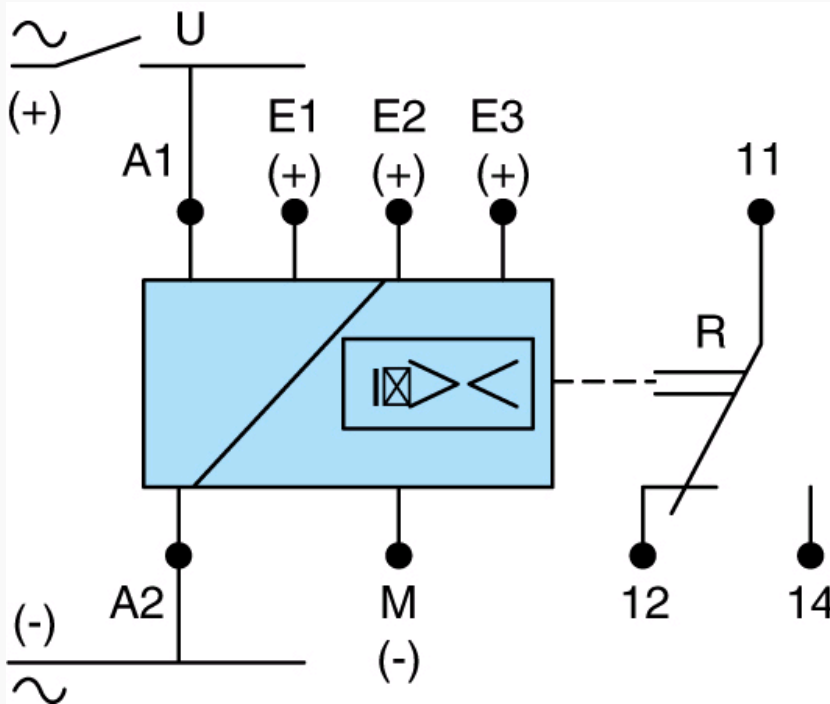

A1 - A2 : Powere supply

Legend

Connections

CA 84871030



A1 - A2 : Powere supply