



## RD24 Steckverbinder RD24 connectors

### Kabelsteckverbinder

- Steckverbinder mit Schraubverriegelung
- Schutzart IP67 <sup>1)</sup>
- Varianten mit VDE-, SEV-, UL-Zulassung
- 3 Anslusstechiken:
  - **LÖT**anschluss
  - **SCHRAUB**anschluss
  - **CRIMP**anschluss für gedrehte Crimpkontakte (die u.a. auch in schweren Rechtecksteckverbindern nach DIN 43 652 eingesetzt werden)

### Cable Connector

- Connector with screw locking
- Degree of protection IP67 <sup>1)</sup>
- Versions with VDE-, SEV-, UL-approval
- 3 termination possibilities:
  - **SOLDER** termination
  - **SCREW** termination
  - **CRIMP** termination for turned crimp contacts (which are used in heavy duty rectangular connectors DIN 43652)



Aufbau des Steckverbinders:  
Construction of the connector:

Kabelstecker  
Male cable connector

Winkelstecker  
Male angled connector

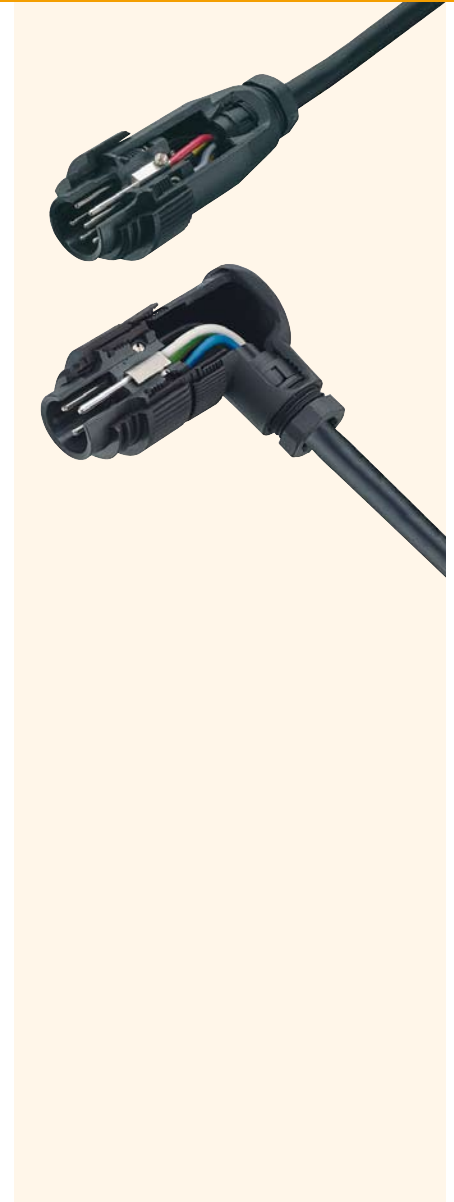

- ü
- Ti
- SI IP40
- SI IP67
- Bojonett
- SI IP67
- PP IP67
- M9 IP40
- M9 IP67
- SI IP67
- Bojonett
- SI IP67
- PP IP67
- M16 IP40
- M16 IP67
- M23
- M23
- Bojonett
- M25
- RD24
- RD30
- M5
- M8
- M12-A
- VL
- M12-PP
- Verteiler
- M12-B
- M12-D
- M12-US
- M18
- 7/8"
- BF-A
- BF-B
- BF-C
- R

**Maschinensteckverbinder Serie 692 - 693**  
**Connectors for machines series 692 - 693**

Bezeichnung  
Description

Kabelstecker, PG9  
Male cable connector, PG9

Kabelstecker, PG9 mit VDE, SEV, UL Zulassung  
Male cable connector, PG9 with VDE, SEV, UL approval

Abbildung  
Figure

Crimpkontakte siehe Seite 27.  
Crimp contacts see page 27.

Crimpkontakte siehe Seite 27.  
Crimp contacts see page 27.



Maßzeichnung  
Drawing

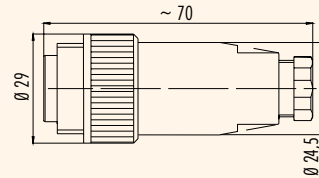
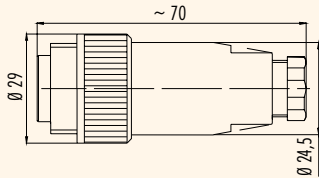

Bestell-Nr.  
Ordering-No.

Polzahl Contacts	Anschlussart Termination	Kabeldurchlass (mm) Cable outlet (mm)	Bestell-Nr. Ordering-No.
3+PE	schrauben screw	6-9,5	99-0209-00-04
6+PE	löten solder	6-9,5	99-0213-00-07
6+PE	schrauben screw	6-8	99-0217-00-07
6+PE	crimpen crimp	6-8	99-0201-00-07

Polzahl Contacts	Anschlussart Termination	Kabeldurchlass (mm) Cable outlet (mm)	Bestell-Nr. Ordering-No.
3+PE	schrauben screw	6-9,5	99-4221-00-04
6+PE	löten solder	6-9,5	99-4225-00-07
6+PE	schrauben screw	6-8	99-4217-00-07
6+PE	crimpen crimp	6-8	99-4201-00-07

Technische Daten  
Specifications

Polzahl	3+PE	6+PE	6+PE	6+PE	Number of contacts
Steckverbinder Verriegelung	schrauben/screw				Connector locking system
Anschlussart	schrauben/screw	löten/solder	schrauben/screw	crimpen/crimp	Termination
Anschlussquerschnitt	0,5-2,5 mm <sup>2</sup> (AWG 20-14)	max. 0,75 mm <sup>2</sup> (max. AWG 18)	0,34-1,5 mm <sup>2</sup> (AWG 22-16)	0,14-1,5 mm <sup>2</sup> (AWG 26-16)	Wire gauge
Kabeldurchlass	6-8 mm, 6-9,5 mm				Cable outlet
Schutzart	IP67 <sup>1)</sup>				Degree of protection
Mechanische Lebensdauer	> 500 Steckzyklen / > 500 mating cycles				Mechanical operation
Obere Grenztemperatur	+ 100 °C				Upper temperature
Untere Grenztemperatur	- 40 °C				Lower temperature
Bemessungsspannung	400 V (600 V UL)		250 V		Rated voltage
Bemessungs-Stoßspannung	6000 V		4000 V		Rated impulse voltage
Verschmutzungsgrad	3				Pollution degree
Überspannungskategorie	III				Overvoltage categorie
Isolierstoffgruppe	III				Material group
Bemessungsstrom (40°C)	16 A (12 A UL)		10 A (8 A UL)		Rated current (40 °C)
Durchgangswiderstand	≤ 5 mΩ				Contact resistance
Material Kontakt	CuZn (Messing/brass)				Material of contact
Kontaktoberfläche	Ag (Silber/silver)				Contact plating
Material Kontaktkörper	PBT (UL 94 V-0)				Material of contact body
Material Gehäuse	PBT (UL 94 V-0)				Material of housing

## Maschinensteckverbinder Serie 692 - 693

### Connectors for machines series 692 - 693

Bezeichnung  
Description

Kabelstecker, PG11  
Male cable connector, PG11

Kabelstecker, PG11 mit VDE, SEV, UL Zulassung  
Male cable connector, PG11 with VDE, SEV, UL approval

Abbildung  
Figure

Crimpkontakte siehe Seite 27.  
Crimp contacts see page 27.

Crimpkontakte siehe Seite 27.  
Crimp contacts see page 27.



Maßzeichnung  
Drawing

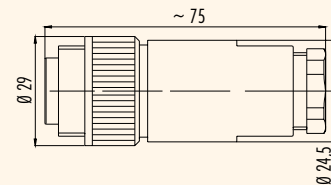
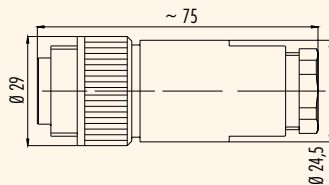

Bestell-Nr.  
Ordering-No.

Polzahl Contacts	Anschlussart Termination	Kabeldurchlass (mm) Cable outlet (mm)	Bestell-Nr. Ordering-No.	Polzahl Contacts	Anschlussart Termination	Kabeldurchlass (mm) Cable outlet (mm)	Bestell-Nr. Ordering-No.
3+PE	schrauben screw	8-10	99-0209-110-04	3+PE	schrauben screw	8-10	99-4221-110-04
6+PE	löten solder	8-10	99-0213-110-07	6+PE	löten solder	8-10	99-4225-110-07
6+PE	schrauben screw	8-10	99-0217-110-07	6+PE	schrauben screw	8-10	99-4217-110-07
6+PE	crimpen crimp	8-10	99-0201-110-07	6+PE	crimpen crimp	8-10	99-4201-110-07

Technische Daten  
Specifications

Polzahl	3+PE	6+PE	6+PE	6+PE	Number of contacts
Steckverbinder Verriegelung	schrauben/screw				Connector locking system
Anschlussart	schrauben/screw	löten/solder	schrauben/screw	crimpen/crimp	Termination
Anschlussquerschnitt	0,5-2,5 mm <sup>2</sup> (AWG 20-14)	max. 0,75 mm <sup>2</sup> (max. AWG 18)	0,34-1,5 mm <sup>2</sup> (AWG 22-16)	0,14-1,5 mm <sup>2</sup> (AWG 26-16)	Wire gauge
Kabeldurchlass	8-10 mm				Cable outlet
Schutzart	IP67				Degree of protection
Mechanische Lebensdauer	> 500 Steckzyklen/> 500 mating cycles				Mechanical operation
Obere Grenztemperatur	+ 100 °C				Upper temperature
Untere Grenztemperatur	- 40 °C				Lower temperature
Bemessungsspannung	400 V (600 V UL)		250 V		Rated voltage
Bemessungsstoßspannung	6000 V		4000 V		Rated impulse voltage
Verschmutzungsgrad	3				Pollution degree
Überspannungskategorie	III				Overvoltage categorie
Isolierstoffgruppe	III				Material group
Bemessungsstrom (40°C)	16 A (12 A UL)		10 A (8 A UL)		Rated current (40 °C)
Durchgangswiderstand	≤ 5 mΩ				Contact resistance
Material Kontakt	CuZn (Messing/brass)				Material of contact
Kontaktoberfläche	Ag (Silber/silver)				Contact plating
Material Kontaktkörper	PBT (UL 94 V-0)				Material of contact body
Material Gehäuse	PBT (UL 94 V-0)				Material of housing

## Maschinensteckverbinder Serie 692 - 693

### Connectors for machines series 692 - 693

Bezeichnung  
Description

Kabelstecker, PG13,5  
Male cable connector, PG13,5

Abbildung  
Figure

Crimpkontakte siehe Seite 27.  
Crimp contacts see page 27.



Kabelstecker, PG13,5 mit VDE, SEV, UL Zulassung  
Male cable connector, PG13,5 with VDE, SEV, UL approval

Crimpkontakte siehe Seite 27.  
Crimp contacts see page 27.



Maßzeichnung  
Drawing

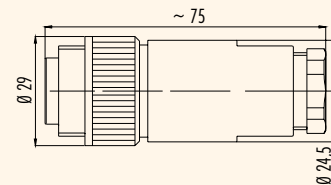
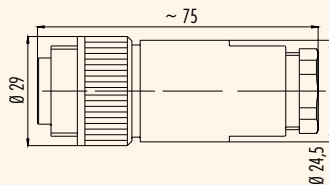

Bestell-Nr.  
Ordering-No.

Polzahl Contacts	Anschlussart Termination	Kabeldurchlass (mm) Cable outlet (mm)	Bestell-Nr. Ordering-No.	Polzahl Contacts	Anschlussart Termination	Kabeldurchlass (mm) Cable outlet (mm)	Bestell-Nr. Ordering-No.
3+PE	schrauben screw	10-12	99-0209-15-04	3+PE	schrauben screw	10-12	99-4221-14-04
6+PE	löten solder	10-12	99-0213-15-07	6+PE	löten solder	10-12	99-4225-14-07
6+PE	schrauben screw	10-12	99-0217-15-07	6+PE	schrauben screw	10-12	99-4217-14-07
6+PE	crimpen crimp	10-12	99-0201-15-07	6+PE	crimpen crimp	10-12	99-4201-14-07

Technische Daten  
Specifications

Polzahl	3+PE	6+PE	6+PE	6+PE	Number of contacts
Steckverbinder Verriegelung	schrauben/screw				Connector locking system
Anschlussart	schrauben/screw	löten/solder	schrauben/screw	crimpen/crimp	Termination
Anschlussquerschnitt	0,5-2,5 mm <sup>2</sup> (AWG 20-14)	max. 0,75 mm <sup>2</sup> (max. AWG 18)	0,34-1,5 mm <sup>2</sup> (AWG 22-16)	0,14-1,5 mm <sup>2</sup> (AWG 26-16)	Wire gauge
Kabeldurchlass	10-12 mm				Cable outlet
Schutzart	IP67				Degree of protection
Mechanische Lebensdauer	> 500 Steckzyklen/> 500 mating cycles				Mechanical operation
Obere Grenztemperatur	+ 100 °C				Upper temperature
Untere Grenztemperatur	- 40 °C				Lower temperature
Bemessungsspannung	400 V (600 V UL)		250 V		Rated voltage
Bemessungs-Stoßspannung	6000 V		4000 V		Rated impulse voltage
Verschmutzungsgrad	3				Pollution degree
Überspannungskategorie	III				Overvoltage categorie
Isolierstoffgruppe	III				Material group
Bemessungsstrom (40 °C)	16 A (12 A UL)		10 A (8 A UL)		Rated current (40 °C)
Durchgangswiderstand	≤ 5 mΩ				Contact resistance
Material Kontakt	CuZn (Messing/brass)				Material of contact
Kontaktoberfläche	Ag (Silber/silver)				Contact plating
Material Kontaktkörper	PBT (UL 94 V-0)				Material of contact body
Material Gehäuse	PBT (UL 94 V-0)				Material of housing

## Maschinensteckverbinder Serie 692 - 693

### Connectors for machines series 692 - 693

**Bezeichnung**  
Description

**Kabelstecker, PG16**  
Male cable connector, PG16

**Kabelstecker, PG16 mit VDE, SEV, UL Zulassung**  
Male cable connector, PG16 with VDE, SEV, UL approval

**Abbildung**  
Figure

**Crimpkontakte siehe Seite 27.**  
Crimp contacts see page 27.

**Crimpkontakte siehe Seite 27.**  
Crimp contacts see page 27.

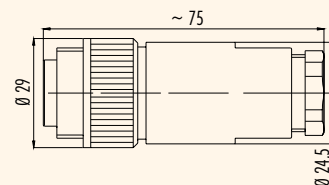
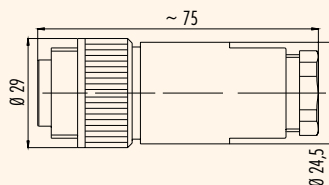
**Maßzeichnung**  
Drawing

**Bestell-Nr.**  
Ordering-No.

Polzahl Contacts	Anschlussart Termination	Kabeldurchlass (mm) Cable outlet (mm)	Bestell-Nr. Ordering-No.	Polzahl Contacts	Anschlussart Termination	Kabeldurchlass (mm) Cable outlet (mm)	Bestell-Nr. Ordering-No.
3+PE	schrauben screw	12-14	99-0209-160-04	3+PE	schrauben screw	12-14	99-4221-160-04
6+PE	löten solder	12-14	99-0213-160-07	6+PE	löten solder	12-14	99-4225-160-07
6+PE	schrauben screw	12-14	99-0217-160-07	6+PE	schrauben screw	12-14	99-4217-160-07
6+PE	crimpen crimp	12-14	99-0201-160-07	6+PE	crimpen crimp	12-14	99-4201-160-07

**Technische Daten**  
Specifications

Polzahl	3+PE	6+PE	6+PE	6+PE	Number of contacts
Steckverbinder Verriegelung	schrauben/screw				Connector locking system
Anschlussart	schrauben/screw	löten/solder	schrauben/screw	crimpen/crimp	Termination
Anschlussquerschnitt	0,5-2,5 mm <sup>2</sup> (AWG 20-14)	max. 0,75 mm <sup>2</sup> (max. AWG 18)	0,34-1,5 mm <sup>2</sup> (AWG 22-16)	0,14-1,5 mm <sup>2</sup> (AWG 26-16)	Wire gauge
Kabeldurchlass	12-14 mm				Cable outlet
Schutzart	IP67				Degree of protection
Mechanische Lebensdauer	> 500 Steckzyklen/> 500 mating cycles				Mechanical operation
Obere Grenztemperatur	+ 100 °C				Upper temperature
Untere Grenztemperatur	- 40 °C				Lower temperature
Bemessungsspannung	400 V (600 V UL)		250 V		Rated voltage
Bemessungsstoßspannung	6000 V		4000 V		Rated impulse voltage
Verschmutzungsgrad	3				Pollution degree
Überspannungskategorie	III				Overvoltage categorie
Isolierstoffgruppe	III				Material group
Bemessungsstrom (40°C)	16 A (12 A UL)		10 A (8 A UL)		Rated current (40 °C)
Durchgangswiderstand	≤ 5 mΩ				Contact resistance
Material Kontakt	CuZn (Messing/brass)				Material of contact
Kontaktoberfläche	Ag (Silber/silver)				Contact plating
Material Kontaktkörper	PBT (UL 94 V-0)				Material of contact body
Material Gehäuse	PBT (UL 94 V-0)				Material of housing

**Maschinensteckverbinder Serie 692 - 693**  
**Connectors for machines series 692 - 693**

Bezeichnung  
Description

Winkelstecker, PG9  
Male angled connector, PG9

Winkelstecker, PG9 mit VDE, SEV, UL Zulassung  
Male angled connector, PG9 with VDE, SEV, UL approval

Abbildung  
Figure

Crimpkontakte siehe Seite 27.  
Crimp contacts see page 27.

Crimpkontakte siehe Seite 27.  
Crimp contacts see page 27.



Maßzeichnung  
Drawing

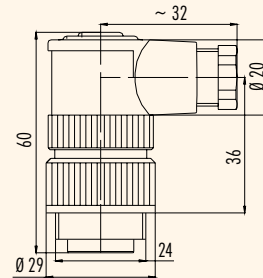
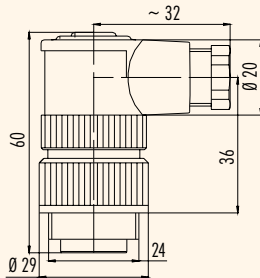

Bestell-Nr.  
Ordering-No.

Polzahl Contacts	Anschlussart Termination	Kabeldurchlass (mm) Cable outlet (mm)	Bestell-Nr. Ordering-No.
3+PE	schrauben screw	6-8	99-0209-70-04
6+PE	löten solder	6-8	99-0213-70-07
6+PE	schrauben screw	6-8	99-0217-70-07
6+PE	crimpen crimp	6-8	99-0201-70-07

Polzahl Contacts	Anschlussart Termination	Kabeldurchlass (mm) Cable outlet (mm)	Bestell-Nr. Ordering-No.
3+PE	schrauben screw	6-8	99-4221-70-04
6+PE	löten solder	6-8	99-4225-70-07
6+PE	schrauben screw	6-8	99-4217-70-07
6+PE	crimpen crimp	6-8	99-4201-70-07

Technische Daten  
Specifications

Polzahl	3+PE	6+PE	6+PE	6+PE	Number of contacts
Steckverbinder Verriegelung	schrauben/screw				Connector locking system
Anschlussart	schrauben/screw	löten/solder	schrauben/screw	crimpen/crimp	Termination
Anschlussquerschnitt	0,5-2,5 mm <sup>2</sup> (AWG 20-14)	max. 0,75 mm <sup>2</sup> (max. AWG 18)	0,34-1,5 mm <sup>2</sup> (AWG 22-16)	0,14-1,5 mm <sup>2</sup> (AWG 26-16)	Wire gauge
Kabeldurchlass	6-8 mm				Cable outlet
Schutzart	IP67 <sup>1)</sup>				Degree of protection
Mechanische Lebensdauer	> 500 Steckzyklen/> 500 mating cycles				Mechanical operation
Obere Grenztemperatur	+ 100 °C				Upper temperature
Untere Grenztemperatur	- 40 °C				Lower temperature
Bemessungsspannung	400 V (600 V UL)	250 V		4000 V	Rated voltage
Bemessungsstoßspannung	6000 V	4000 V			Rated impulse voltage
Verschmutzungsgrad	3				Pollution degree
Überspannungskategorie	III				Overvoltage categorie
Isolierstoffgruppe	III				Material group
Bemessungsstrom (40°C)	16 A (12 A UL)	10 A (8 A UL)			Rated current (40 °C)
Durchgangswiderstand	≤ 5 mΩ				Contact resistance
Material Kontakt	CuZn (Messing/brass)				Material of contact
Kontaktoberfläche	Ag (Silber/silver)				Contact plating
Material Kontaktkörper	PBT (UL 94 V-0)				Material of contact body
Material Gehäuse	PBT (UL 94 V-0)				Material of housing

**Maschinensteckverbinder Serie 692 - 693**  
**Connectors for machines series 692 - 693**
**Bezeichnung**  
*Description*
**Kabelstecker**  
*Male cable connector*
**Winkelstecker**  
*Male angled connector*
**Abbildung**  
*Figure*

 Technische Kabeldaten siehe Seite 24.  
*Specifications of cable see page 24.*

 Technische Kabeldaten siehe Seite 24.  
*Specifications of cable see page 24.*

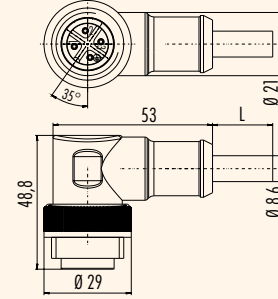
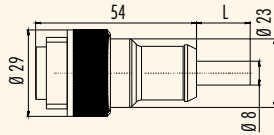
**Maßzeichnung**  
*Drawing*

**Bestell-Nr.**  
*Ordering-No.*

Polzahl Contacts	Bestell-Nr. Ordering-No.
3+PE 4 x 1,5 PVC	79-0231-20-04

Polzahl Contacts	Bestell-Nr. Ordering-No.
3+PE 4 x 1,5 PVC	79-0233-20-04

**Technische Daten**  
*Specifications*

Polzahl	3+PE	Number of contacts
Steckverbinder Verriegelung	schrauben/screw	Connector locking system
Anschlussart	crimpen, am Kabel angespritzt/crimp, moulded	Termination
Anschlussquerschnitt	1,5 mm <sup>2</sup> (AWG 16)	Wire gauge
Kabeldurchlass	-	Cable outlet
Schutzart	IP67	Degree of protection
Mechanische Lebensdauer	> 500 Steckzyklen/> 500 mating cycles	Mechanical operation
Obere Grenztemperatur	+ 80 °C	Upper temperature
Untere Grenztemperatur	- 40 °C	Lower temperature
Bemessungsspannung	400 V	Rated voltage
Bemessungs-Stoßspannung	6000 V	Rated impulse voltage
Verschmutzungsgrad	3	Pollution degree
Überspannungskategorie	III	Overvoltage categorie
Isolierstoffgruppe	III	Material group
Bemessungsstrom (40°C)	16 A	Rated current (40 °C)
Durchgangswiderstand	≤ 5 mΩ	Contact resistance
Material Kontakt	CuZn (Messing/brass)	Material of contact
Kontaktoberfläche	Ag (Silber/silver)	Contact plating
Material Kontaktkörper	PBT (UL 94 HB)	Material of contact body
Material Gehäuse	PUR	Material of housing



## Maschinensteckverbinder Serie 692 - 693

### Connectors for machines series 692 - 693

Bezeichnung  
Description

Kabeldose, PG9  
Female cable connector, PG9

Abbildung  
Figure

Crimpkontakte siehe Seite 27.  
Crimp contacts see page 27.



Kabeldose, PG9 mit VDE, SEV, UL Zulassung  
Female cable connector, PG9 with VDE, SEV, UL approval

Crimpkontakte siehe Seite 27.  
Crimp contacts see page 27.



Maßzeichnung  
Drawing

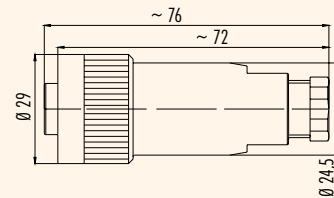
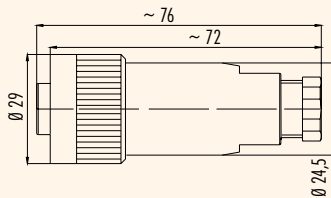

Bestell-Nr.  
Ordering-No.

Polzahl Contacts	Anschlussart Termination	Kabeldurchlass (mm) Cable outlet (mm)	Bestell-Nr. Ordering-No.	Polzahl Contacts	Anschlussart Termination	Kabeldurchlass (mm) Cable outlet (mm)	Bestell-Nr. Ordering-No.
3+PE	schrauben screw	6-9,5	99-0210-00-04	3+PE	schrauben screw	6-9,5	99-4222-00-04
6+PE	löten solder	6-9,5	99-0214-00-07	6+PE	löten solder	6-9,5	99-4226-00-07
6+PE	schrauben screw	6-8	99-0218-00-07	6+PE	schrauben screw	6-8	99-4218-00-07
6+PE	crimpen crimp	6-8	99-0202-00-07	6+PE	crimpen crimp	6-8	99-4202-00-07

Technische Daten  
Specifications

Polzahl	3+PE	6+PE	6+PE	6+PE	Number of contacts
Steckverbinder Verriegelung	schrauben/screw				Connector locking system
Anschlussart	schrauben/screw	löten/solder	schrauben/screw	crimpen/crimp	Termination
Anschlussquerschnitt	0,5-2,5 mm <sup>2</sup> (AWG 20-14)	max. 0,75 mm <sup>2</sup> (max. AWG 18)	0,34-1,5 mm <sup>2</sup> (AWG 22-16)	0,14-1,5 mm <sup>2</sup> (AWG 26-16)	Wire gauge
Kabeldurchlass	6-8 mm, 6-9,5 mm				Cable outlet
Schutzart	IP67 <sup>1)</sup>				Degree of protection
Mechanische Lebensdauer	> 500 Steckzyklen / > 500 mating cycles				Mechanical operation
Obere Grenztemperatur	+ 100 °C				Upper temperature
Untere Grenztemperatur	- 40 °C				Lower temperature
Bemessungsspannung	400 V (600 V UL)		250 V		Rated voltage
Bemessungs-Stoßspannung	6000 V		4000 V		Rated impulse voltage
Verschmutzungsgrad	3				Pollution degree
Überspannungskategorie	III				Overvoltage categorie
Isolierstoffgruppe	III				Material group
Bemessungsstrom (40 °C)	16 A (12 A UL)		10 A (8 A UL)		Rated current (40 °C)
Durchgangswiderstand	≤ 5 mΩ				Contact resistance
Material Kontakt	CuSn (Bronze/bronze), CuZn (Messing/brass)				Material of contact
Kontaktoberfläche	Ag (Silber/silver)				Contact plating
Material Kontaktkörper	PBT (UL 94 V-0)				Material of contact body
Material Gehäuse	PBT (UL 94 V-0)				Material of housing

## Maschinensteckverbinder Serie 692 - 693

### Connectors for machines series 692 - 693

Bezeichnung  
Description

Abbildung  
Figure

Kabeldose, PG11  
Female cable connector, PG11

Crimpkontakte siehe Seite 27.  
Crimp contacts see page 27.



Kabeldose, PG11 mit VDE, SEV, UL Zulassung  
Female cable connector, PG11 with VDE, SEV, UL approval

Crimpkontakte siehe Seite 27.  
Crimp contacts see page 27.



Maßzeichnung  
Drawing

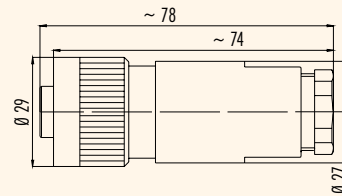
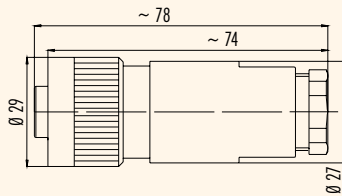

Bestell-Nr.  
Ordering-No.

Polzahl Contacts	Anschlussart Termination	Kabeldurchlass (mm) Cable outlet (mm)	Bestell-Nr. Ordering-No.
3+PE	schrauben screw	8-10	99-0210-110-04
6+PE	löten solder	8-10	99-0214-110-07
6+PE	schrauben screw	8-10	99-0218-110-07
6+PE	crimpen crimp	8-10	99-0202-110-07

Polzahl Contacts	Anschlussart Termination	Kabeldurchlass (mm) Cable outlet (mm)	Bestell-Nr. Ordering-No.
3+PE	schrauben screw	8-10	99-4222-110-04
6+PE	löten solder	8-10	99-4226-110-07
6+PE	schrauben screw	8-10	99-4218-110-07
6+PE	crimpen crimp	8-10	99-4202-110-07

Technische Daten  
Specifications

	3+PE	6+PE	6+PE	6+PE	Number of contacts
Steckverbinder Verriegelung	schrauben/screw				Connector locking system
Anschlussart	schrauben/screw	löten/solder	schrauben/screw	crimpen/crimp	Termination
Anschlussquerschnitt	0,5-2,5 mm <sup>2</sup> (AWG 20-14)	max. 0,75 mm <sup>2</sup> (max. AWG 18)	0,34-1,5 mm <sup>2</sup> (AWG 22-16)	0,14-1,5 mm <sup>2</sup> (AWG 26-16)	Wire gauge
Kabeldurchlass	8-10 mm				Cable outlet
Schutzart	IP67				Degree of protection
Mechanische Lebensdauer	> 500 Steckzyklen/> 500 mating cycles				Mechanical operation
Obere Grenztemperatur	+ 100 °C				Upper temperature
Untere Grenztemperatur	- 40 °C				Lower temperature
Bemessungsspannung	400 V (600 V UL)		250 V		Rated voltage
Bemessungs-Stoßspannung	6000 V		4000 V		Rated impulse voltage
Verschmutzungsgrad	3				Pollution degree
Überspannungskategorie	III				Overvoltage categorie
Isolierstoffgruppe	III				Material group
Bemessungsstrom (40°C)	16 A (12 A UL)		10 A (8 A UL)		Rated current (40 °C)
Durchgangswiderstand	≤ 5 mΩ				Contact resistance
Material Kontakt	CuSn (Bronze/bronce), CuZn (Messing/brass)				Material of contact
Kontaktoberfläche	Ag (Silber/silver)				Contact plating
Material Kontaktkörper	PBT (UL 94 V-0)				Material of contact body
Material Gehäuse	PBT (UL 94 V-0)				Material of housing

## Maschinensteckverbinder Serie 692 - 693

### Connectors for machines series 692 - 693

Bezeichnung  
Description

Kabeldose, PG13,5  
Female cable connector, PG13,5

Kabeldose, PG13,5 mit VDE, SEV, UL Zulassung  
Female cable connector, PG13,5 with VDE, SEV, UL approval

Abbildung  
Figure

Crimpkontakte siehe Seite 27.  
Crimp contacts see page 27.

Crimpkontakte siehe Seite 27.  
Crimp contacts see page 27.



Maßzeichnung  
Drawing

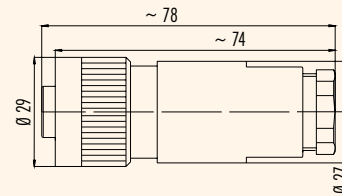
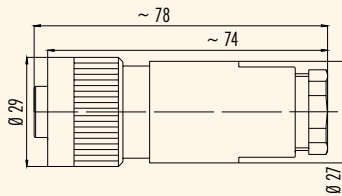

Bestell-Nr.  
Ordering-No.

Polzahl Contacts	Anschlussart Termination	Kabeldurchlass (mm) Cable outlet (mm)	Bestell-Nr. Ordering-No.	Polzahl Contacts	Anschlussart Termination	Kabeldurchlass (mm) Cable outlet (mm)	Bestell-Nr. Ordering-No.
3+PE	schrauben screw	10-12	99-0210-15-04	3+PE	schrauben screw	10-12	99-4222-14-04
6+PE	löten solder	10-12	99-0214-15-07	6+PE	löten solder	10-12	99-4226-14-07
6+PE	schrauben screw	10-12	99-0218-15-07	6+PE	schrauben screw	10-12	99-4218-14-07
6+PE	crimpen crimp	10-12	99-0202-15-07	6+PE	crimpen crimp	10-12	99-4202-14-07

Technische Daten  
Specifications

Polzahl	3+PE	6+PE	6+PE	6+PE	Number of contacts
Steckverbinder Verriegelung	schrauben/screw				Connector locking system
Anschlussart	schrauben/screw	löten/solder	schrauben/screw	crimpen/crimp	Termination
Anschlussquerschnitt	0,5-2,5 mm <sup>2</sup> (AWG 20-14)	max. 0,75 mm <sup>2</sup> (max. AWG 18)	0,34-1,5 mm <sup>2</sup> (AWG 22-16)	0,14-1,5 mm <sup>2</sup> (AWG 26-16)	Wire gauge
Kabeldurchlass	10-12 mm				Cable outlet
Schutzart	IP67				Degree of protection
Mechanische Lebensdauer	> 500 Steckzyklen/> 500 mating cycles				Mechanical operation
Obere Grenztemperatur	+ 100 °C				Upper temperature
Untere Grenztemperatur	- 40 °C				Lower temperature
Bemessungsspannung	400 V (600 V UL)		250 V		Rated voltage
Bemessungs-Stoßspannung	6000 V		4000 V		Rated impulse voltage
Verschmutzungsgrad	3				Pollution degree
Überspannungskategorie	III				Overvoltage categorie
Isolierstoffgruppe	III				Material group
Bemessungsstrom (40 °C)	16 A (12 A UL)		10 A (8 A UL)		Rated current (40 °C)
Durchgangswiderstand	≤ 5 mΩ				Contact resistance
Material Kontakt	CuSn (Bronze/bronze), CuZn (Messing/brass)				Material of contact
Kontaktoberfläche	Ag (Silber/silver)				Contact plating
Material Kontaktkörper	PBT (UL 94 V-0)				Material of contact body
Material Gehäuse	PBT (UL 94 V-0)				Material of housing

**Maschinensteckverbinder Serie 692 - 693**  
**Connectors for machines series 692 - 693**
**Bezeichnung**  
*Description*
**Abbildung**  
*Figure*
**Kabeldose, PG16**  
*Female cable connector, PG16*
**Crimpkontakte siehe Seite 27.**  
*Crimp contacts see page 27.*

**Kabeldose, PG16 mit VDE, SEV, UL Zulassung**  
*Female cable connector, PG16 with VDE, SEV, UL approval*
**Crimpkontakte siehe Seite 27.**  
*Crimp contacts see page 27.*

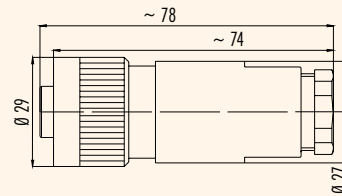
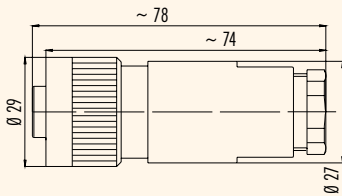
**Maßzeichnung**  
*Drawing*

**Bestell-Nr.**  
*Ordering-No.*

Polzahl Contacts	Anschlussart Termination	Kabeldurchlass (mm) Cable outlet (mm)	Bestell-Nr. Ordering-No.	Polzahl Contacts	Anschlussart Termination	Kabeldurchlass (mm) Cable outlet (mm)	Bestell-Nr. Ordering-No.
3+PE	schrauben screw	12-14	99-0210-160-04	3+PE	schrauben screw	12-14	99-4222-160-04
6+PE	löten solder	12-14	99-0214-160-07	6+PE	löten solder	12-14	99-4226-160-07
6+PE	schrauben screw	12-14	99-0218-160-07	6+PE	schrauben screw	12-14	99-4218-160-07
6+PE	crimpen crimp	12-14	99-0202-160-07	6+PE	crimpen crimp	12-14	99-4202-160-07

**Technische Daten**  
*Specifications*

Polzahl	3+PE	6+PE	6+PE	6+PE	Number of contacts
Steckverbinder Verriegelung	schrauben/screw				Connector locking system
Anschlussart	schrauben/screw	löten/solder	schrauben/screw	crimpen/crimp	Termination
Anschlussquerschnitt	0,5-2,5 mm <sup>2</sup> (AWG 20-14)	max. 0,75 mm <sup>2</sup> (max. AWG 18)	0,34-1,5 mm <sup>2</sup> (AWG 22-16)	0,14-1,5 mm <sup>2</sup> (AWG 26-16)	Wire gauge
Kabeldurchlass	12-14 mm				Cable outlet
Schutzart	IP67				Degree of protection
Mechanische Lebensdauer	> 500 Steckzyklen/> 500 mating cycles				Mechanical operation
Obere Grenztemperatur	+ 100 °C				Upper temperature
Untere Grenztemperatur	- 40 °C				Lower temperature
Bemessungsspannung	400 V (600 V UL)		250 V		Rated voltage
Bemessungs-Stoßspannung	6000 V		4000 V		Rated impulse voltage
Verschmutzungsgrad	3				Pollution degree
Überspannungskategorie	III				Overvoltage categorie
Isolierstoffgruppe	III				Material group
Bemessungsstrom (40°C)	16 A (12 A UL)		10 A (8 A UL)		Rated current (40 °C)
Durchgangswiderstand	≤ 5 mΩ				Contact resistance
Material Kontakt	CuSn (Bronze/bronze), CuZn (Messing/brass)				Material of contact
Kontaktoberfläche	Ag (Silber/silver)				Contact plating
Material Kontaktkörper	PBT (UL 94 V-0)				Material of contact body
Material Gehäuse	PBT (UL 94 V-0)				Material of housing

## Maschinensteckverbinder Serie 692 - 693

### Connectors for machines series 692 - 693

Bezeichnung  
Description

Winkeldose, PG9  
Female angled connector, PG9

Abbildung  
Figure

Crimpkontakte siehe Seite 27.  
Crimp contacts see page 27.



Winkeldose, PG9 mit VDE, SEV, UL Zulassung  
Female angled connector, PG9 with VDE, SEV, UL approval

Crimpkontakte siehe Seite 27.  
Crimp contacts see page 27.



Maßzeichnung  
Drawing

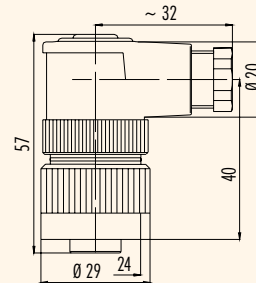
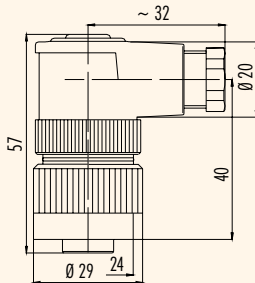

Bestell-Nr.  
Ordering-No.

Polzahl Contacts	Anschlussart Termination	Kabeldurchlass (mm) Cable outlet (mm)	Bestell-Nr. Ordering-No.	Polzahl Contacts	Anschlussart Termination	Kabeldurchlass (mm) Cable outlet (mm)	Bestell-Nr. Ordering-No.
3+PE	schrauben screw	6-8	99-0210-70-04	3+PE	schrauben screw	6-8	99-4222-70-04
6+PE	löten solder	6-8	99-0214-70-07	6+PE	löten solder	6-8	99-4226-70-07
6+PE	schrauben screw	6-8	99-0218-70-07	6+PE	schrauben screw	6-8	99-4218-70-07
6+PE	crimpen crimp	6-8	99-0202-70-07	6+PE	crimpen crimp	6-8	99-4202-70-07

Technische Daten  
Specifications

Polzahl	3+PE	6+PE	6+PE	6+PE	Number of contacts
Steckverbinder Verriegelung	schrauben/screw				Connector locking system
Anschlussart	schrauben/screw	löten/solder	schrauben/screw	crimpen/crimp	Termination
Anschlussquerschnitt	0,5-2,5 mm <sup>2</sup> (AWG 20-14)	max. 0,75 mm <sup>2</sup> (max. AWG 18)	0,34-1,5 mm <sup>2</sup> (AWG 22-16)	0,14-1,5 mm <sup>2</sup> (AWG 26-16)	Wire gauge
Kabeldurchlass	6-8 mm				Cable outlet
Schutzart	IP67 <sup>1)</sup>				Degree of protection
Mechanische Lebensdauer	> 500 Steckzyklen/> 500 mating cycles				Mechanical operation
Obere Grenztemperatur	+ 100 °C				Upper temperature
Untere Grenztemperatur	- 40 °C				Lower temperature
Bemessungsspannung	400 V (600 V UL)		250 V		Rated voltage
Bemessungs-Stoßspannung	6000 V		4000 V		Rated impulse voltage
Verschmutzungsgrad	3				Pollution degree
Überspannungskategorie	III				Overvoltage categorie
Isolierstoffgruppe	III				Material group
Bemessungsstrom (40 °C)	16 A (12 A UL)		10 A (8 A UL)		Rated current (40 °C)
Durchgangswiderstand	≤ 5 mΩ				Contact resistance
Material Kontakt	CuSn (Bronze/bronze), CuZn (Messing/brass)				Material of contact
Kontaktoberfläche	Ag (Silber/silver)				Contact plating
Material Kontaktkörper	PBT (UL 94 V-0)				Material of contact body
Material Gehäuse	PBT (UL 94 V-0)				Material of housing

**Maschinensteckverbinder Serie 692 - 693**  
**Connectors for machines series 692 - 693**
**Bezeichnung**  
*Description*
**Kabeldose**  
*Female cable connector*
**Winkeldose**  
*Female angled connector*
**Abbildung**  
*Figure*

 Technische Kabeldaten siehe Seite 24.  
*Specifications of cable see page 24.*

 Technische Kabeldaten siehe Seite 24.  
*Specifications of cable see page 24.*

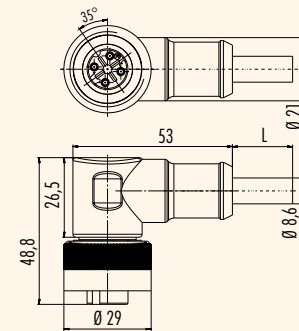
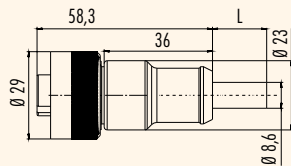
**Maßzeichnung**  
*Drawing*

**Bestell-Nr.**  
*Ordering-No.*

Polzahl Contacts	Bestell-Nr. Ordering-No.
3+PE 4 x 1,5 PVC	79-0232-20-04

Polzahl Contacts	Bestell-Nr. Ordering-No.
3+PE 4 x 1,5 PVC	79-0234-20-04

**Technische Daten**  
*Specifications*

Polzahl	3+PE	Number of contacts
Steckverbinder Verriegelung	Schrauben/screw	Connector locking system
Anschlussart	crimpen, am Kabel angespritzt/crimp, moulded	Termination
Anschlussquerschnitt	1,5 mm <sup>2</sup> (AWG 16)	Wire gauge
Kabeldurchlass	-	Cable outlet
Schutzart	IP67	Degree of protection
Mechanische Lebensdauer	> 500 Steckzyklen/> 500 mating cycles	Mechanical operation
Obere Grenztemperatur	+ 80 °C	Upper temperature
Untere Grenztemperatur	- 40 °C	Lower temperature
Bemessungsspannung	400 V	Rated voltage
Bemessungs-Stoßspannung	6000 V	Rated impulse voltage
Verschmutzungsgrad	3	Pollution degree
Überspannungskategorie	III	Overvoltage categorie
Isolierstoffgruppe	III	Material group
Bemessungsstrom (40°C)	16 A	Rated current (40 °C)
Durchgangswiderstand	≤ 5 mΩ	Contact resistance
Material Kontakt	CuSn (Bronze/bronze), CuZn (Messing/brass)	Material of contact
Kontaktoberfläche	Ag (Silber/silver)	Contact plating
Material Kontaktkörper	PBT (UL 94 HB)	Material of contact body
Material Gehäuse	PUR	Material of housing

**Maschinensteckverbinder Serie 692 - 693**  
**Connectors for machines series 692 - 693**

Bezeichnung  
Description

Flanschstecker 3+PE, Schraubanschluss  
Male socket 3+PE, screw termination

Flanschstecker 3+PE, Schraubanschluss,  
VDE, SEV, UL Zulassung  
Male socket 3+PE, screw termination  
VDE, SEV, UL approval

Abbildung  
Figure



Maßzeichnung  
Drawing

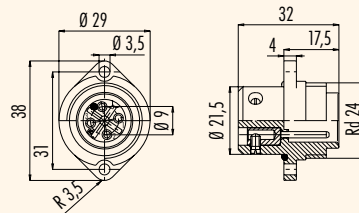
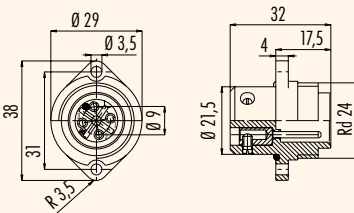

Bestell-Nr.  
Ordering-No.

Polzahl Contacts	Bestell-Nr. Ordering-No.
3+PE	09-0211-00-04

Polzahl Contacts	Bestell-Nr. Ordering-No.
3+PE	09-4223-00-04

**Technische Daten**  
Specifications

Polzahl	3+PE	Number of contacts
Steckverbinder Verriegelung	Schrauben/screw	Connector locking system
Anschlussart	Schrauben/screw	Termination
Anschlussquerschnitt	0,5-2,5 mm <sup>2</sup> (AWG 20-14)	Wire gauge
Kabeldurchlass	-	Cable outlet
Schutzart	IP67	Degree of protection
Mechanische Lebensdauer	> 500 Steckzyklen/> 500 mating cycles	Mechanical operation
Obere Grenztemperatur	+ 100 °C	Upper temperature
Untere Grenztemperatur	- 40 °C	Lower temperature
Bemessungsspannung	400 V (600 V UL)	Rated voltage
Bemessungs-Stoßspannung	6000 V	Rated impulse voltage
Verschmutzungsgrad	3	Pollution degree
Überspannungskategorie	III	Overvoltage category
Isolierstoffgruppe	III	Material group
Bemessungsstrom (40°C)	16 A (12 A UL)	Rated current (40 °C)
Durchgangswiderstand	≤ 3 mΩ	Contact resistance
Material Kontakt	CuZn (Messing/brass)	Material of contact
Kontaktoberfläche	Ag (Silber/silver)	Contact plating
Material Kontaktkörper	PBT	Material of contact body
Material Gehäuse	-	Material of housing

**Maschinensteckverbinder Serie 692 - 693**  
**Connectors for machines series 692 - 693**
**Bezeichnung**  
*Description*
**Flanschstecker 6+PE, Lötanschluss**  
**Male socket 6+PE, solder termination**
**Flanschstecker 6+PE, Lötanschluss**  
**VDE, SEV, UL Zulassung**  
**Male socket 6+PE, solder termination**  
**VDE, SEV, UL approval**
**Abbildung**  
*Figure*

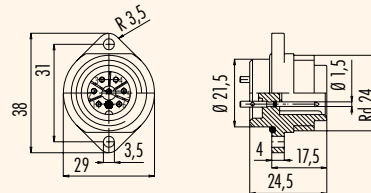
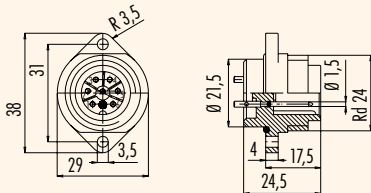
**Maßzeichnung**  
*Drawing*

**Bestell-Nr.**  
**Ordering-No.**

Polzahl Contacts	Bestell-Nr. Ordering-No.
6+PE	09-0215-00-07

Polzahl Contacts	Bestell-Nr. Ordering-No.
6+PE	09-4227-00-07

**Technische Daten**  
**Specifications**

Polzahl	6+PE	Number of contacts
Steckverbinder Verriegelung	Schrauben/Screw	Connector locking system
Anschlussart	Löten/Solder	Termination
Anschlussquerschnitt	max. 0,75 mm <sup>2</sup> (max. AWG 20)	Wire gauge
Kabeldurchlass	-	Cable outlet
Schutzart	IP67	Degree of protection
Mechanische Lebensdauer	> 500 Steckzyklen/> 500 mating cycles	Mechanical operation
Obere Grenztemperatur	+ 100 °C	Upper temperature
Untere Grenztemperatur	- 40 °C	Lower temperature
Bemessungsspannung	250 V	Rated voltage
Bemessungs-Stoßspannung	4000 V	Rated impulse voltage
Verschmutzungsgrad	3	Pollution degree
Überspannungskategorie	III	Overvoltage category
Isolierstoffgruppe	III	Material group
Bemessungsstrom (40°C)	10 A (8 A UL)	Rated current (40 °C)
Durchgangswiderstand	≤ 3 mΩ	Contact resistance
Material Kontakt	CuZn (Messing/brass)	Material at contact
Kontaktfläche	Ag (Silber/silver)	Contact plating
Material Kontaktkörper	PBT	Material of contact body
Material Gehäuse	-	Material of housing



**Maschinensteckverbinder Serie 692 - 693**  
**Connectors for machines series 692 - 693**

Bezeichnung  
Description

Flanschstecker 6+PE, Schraubanschluss  
Male socket 6+PE, screw termination

Flanschstecker 6+PE, Schraubanschluss  
VDE, SEV, UL Zulassung  
Male socket 6+PE, screw termination  
VDE, SEV, UL approval

Abbildung  
Figure



Maßzeichnung  
Drawing

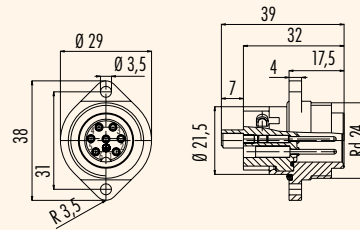
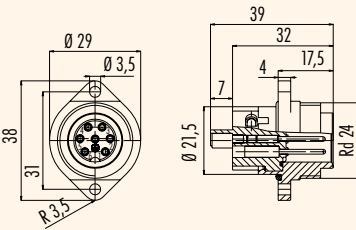

Bestell-Nr.  
Ordering-No.

Polzahl Contacts	Bestell-Nr. Ordering-No.
6+PE	09-0219-00-07

Polzahl Contacts	Bestell-Nr. Ordering-No.
6+PE	09-4219-00-07

Technische Daten  
Specifications

Polzahl	6+PE	Number of contacts
Steckverbinder Verriegelung	Schrauben/screw	Connector locking system
Anschlussart	Schrauben/screw	Termination
Anschlussquerschnitt	0,34-1,5 mm <sup>2</sup> (AWG 22-16)	Wire gauge
Kabeldurchlass	-	Cable outlet
Schutzart	IP67	Degree of protection
Mechanische Lebensdauer	> 500 Steckzyklen/> 500 mating cycles	Mechanical operation
Obere Grenztemperatur	+ 100 °C	Upper temperature
Untere Grenztemperatur	- 40 °C	Lower temperature
Bemessungsspannung	250 V	Rated voltage
Bemessungs-Stoßspannung	4000 V	Rated impulse voltage
Verschmutzungsgrad	3	Pollution degree
Überspannungskategorie	III	Overvoltage categorie
Isolierstoffgruppe	III	Material group
Bemessungsstrom (40°C)	10 A (8 V UL)	Rated current (40 °C)
Durchgangswiderstand	≤ 3 mΩ	Contact resistance
Material Kontakt	CuZn (Messing/brass)	Material of contact
Kontaktoberfläche	Ag (Silber/silver)	Contact plating
Material Kontaktkörper	PA (UL 94 V-0)	Material of contact body
Material Gehäuse	-	Material of housing

## Maschinensteckverbinder Serie 692 - 693

### Connectors for machines series 692 - 693

**Bezeichnung**  
*Description*
**Abbildung**  
*Figure*
**Flanschstecker 6+PE, Crimpschluss**  
**Male socket 6+PE, crimp termination**

 Crimpkontakte siehe Seite 27.  
*Crimp contacts see page 27.*

**Flanschstecker 6+PE, Crimpschluss**  
**VDE, SEV, UL Zulassung**  
**Male socket 6+PE, crimp termination**  
**VDE, SEV, UL approval**

 Crimpkontakte siehe Seite 27.  
*Crimp contacts see page 27.*

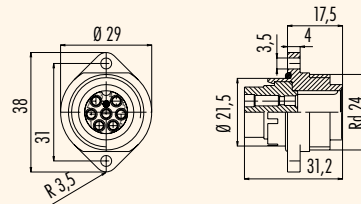
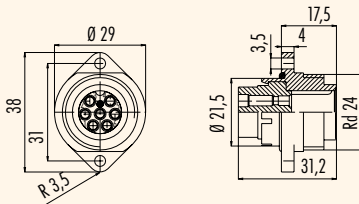
**Maßzeichnung**  
*Drawing*

**Bestell-Nr.**  
**Ordering-No.**

Polzahl Contacts	Bestell-Nr. Ordering-No.
6+PE	09-0203-00-07

Polzahl Contacts	Bestell-Nr. Ordering-No.
6+PE	09-4203-00-07

**Technische Daten**  
**Specifications**

Polzahl	6+PE	Number of contacts
Steckverbinder Verriegelung	Schrauben/screw	Connector locking system
Anschlussart	crimpen/crimp	Termination
Anschlussquerschnitt	0,14-1,5 mm <sup>2</sup> (AWG 26-16)	Wire gauge
Kabeldurchlass	-	Cable outlet
Schutzart	IP67	Degree of protection
Mechanische Lebensdauer	> 500 Steckzyklen/> 500 mating cycles	Mechanical operation
Obere Grenztemperatur	+ 100 °C	Upper temperature
Untere Grenztemperatur	- 40 °C	Lower temperature
Bemessungsspannung	250 V	Rated voltage
Bemessungs-Stoßspannung	4000 V	Rated impulse voltage
Verschmutzungsgrad	3	Pollution degree
Überspannungskategorie	III	Overvoltage categorie
Isolierstoffgruppe	III	Material group
Bemessungsstrom (40°C)	10 A (8 V UL)	Rated current (40 °C)
Durchgangswiderstand	≤ 3 mΩ	Contact resistance
Material Kontakt	CuZn (Messing/brass)	Material at contact
Kontaktoberfläche	Ag (Silber/silver)	Contact plating
Material Kontaktkörper	PBT	Material of contact body
Material Gehäuse	-	Material of housing

**Maschinensteckverbinder Serie 692 - 693**  
**Connectors for machines series 692 - 693**

Bezeichnung  
Description

Flanschdose 3+PE, **Schraubanschluss**  
Female socket 3+PE, **screw termination**

Flanschdose 3+PE, **Schraubanschluss**  
**VDE, SEV, UL Zulassung**  
Female socket 3+PE, **screw termination**  
**VDE, SEV, UL approval**

Abbildung  
Figure



Maßzeichnung  
Drawing

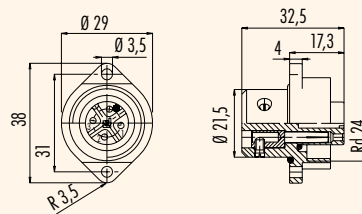
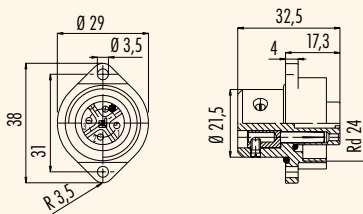

Bestell-Nr.  
Ordering-No.

Polzahl Contacts	Bestell-Nr. Ordering-No.
3+PE	09-0212-00-04

Polzahl Contacts	Bestell-Nr. Ordering-No.
3+PE	09-4224-00-04

**Technische Daten**  
Specifications

Polzahl	3+PE	Number of contacts
Steckverbinder Verriegelung	Schrauben/screw	Connector locking system
Anschlussart	Schrauben/screw	Termination
Anschlussquerschnitt	0,5-2,5 mm <sup>2</sup> (AWG 20-14)	Wire gauge
Kabeldurchlass	-	Cable outlet
Schutzart	IP67	Degree of protection
Mechanische Lebensdauer	> 500 Steckzyklen / > 500 mating cycles	Mechanical operation
Obere Grenztemperatur	+ 100 °C	Upper temperature
Untere Grenztemperatur	- 40 °C	Lower temperature
Bemessungsspannung	400 V (600 V UL)	Rated voltage
Bemessungs-Stoßspannung	6000 V	Rated impulse voltage
Verschmutzungsgrad	3	Pollution degree
Überspannungskategorie	III	Overvoltage category
Isolierstoffgruppe	III	Material group
Bemessungsstrom (40°C)	16 A (12 A UL)	Rated current (40 °C)
Durchgangswiderstand	≤ 3 mΩ	Contact resistance
Material Kontakt	CuSn (Bronze/bronze)	Material of contact
Kontaktoberfläche	Ag (Silber/silver)	Contact plating
Material Kontaktkörper	PBT	Material of contact body
Material Gehäuse	-	Material of housing

**Maschinensteckverbinder Serie 692 - 693**  
**Connectors for machines series 692 - 693**
**Bezeichnung**  
*Description*
**Flanschdose 6+PE, Lötanschluss**  
**Female socket 6+PE, solder termination**
**Flanschdose 6+PE, Lötanschluss**  
**VDE, SEV, UL Zulassung**  
**Female socket 6+PE, solder termination**  
**VDE, SEV, UL approval**
**Abbildung**  
*Figure*

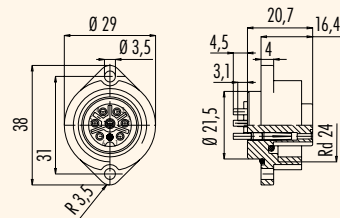
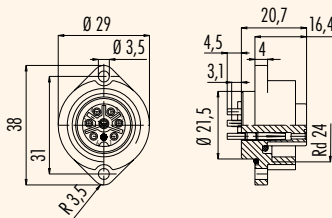
**Maßzeichnung**  
*Drawing*

**Bestell-Nr.**  
**Ordering-No.**

Polzahl Contacts	Bestell-Nr. Ordering-No.
6+PE	09-0216-00-07

Polzahl Contacts	Bestell-Nr. Ordering-No.
6+PE	09-4228-00-07

**Technische Daten**  
**Specifications**

	6+PE	Number of contacts
Steckverbinder Verriegelung	Schrauben/screw	Connector locking system
Anschlussart	löten/solder	Termination
Anschlussquerschnitt	max. 0,75 mm <sup>2</sup> (max. AWG 20)	Wire gauge
Kabeldurchlass	-	Cable outlet
Schutzart	IP67	Degree of protection
Mechanische Lebensdauer	> 500 Steckzyklen/> 500 mating cycles	Mechanical operation
Obere Grenztemperatur	+ 100 °C	Upper temperature
Untere Grenztemperatur	- 40 °C	Lower temperature
Bemessungsspannung	250 V	Rated voltage
Bemessungs-Stoßspannung	4000 V	Rated impulse voltage
Verschmutzungsgrad	3	Pollution degree
Überspannungskategorie	III	Overvoltage categorie
Isolierstoffgruppe	III	Material group
Bemessungsstrom (40°C)	10 A (8 A UL)	Rated current (40 °C)
Durchgangswiderstand	≤ 3 mΩ	Contact resistance
Material Kontakt	CuSn (Bronze/bronze)	Material at contact
Kontaktoberfläche	Ag (Silber/silver)	Contact plating
Material Kontaktkörper	PBT	Material of contact body
Material Gehäuse	-	Material of housing

## Maschinensteckverbinder Serie 692 - 693

### Connectors for machines series 692 - 693

Bezeichnung  
Description

Flanschdose 6+PE, **Schraubanschluss**  
Female socket 6+PE, **screw termination**

Abbildung  
Figure



Flanschdose 6+PE, **Schraubanschluss**  
**VDE, SEV, UL Zulassung**  
Female socket 6+PE, **screw termination**  
**VDE, SEV, UL approval**



Maßzeichnung  
Drawing

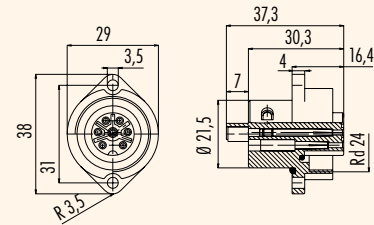
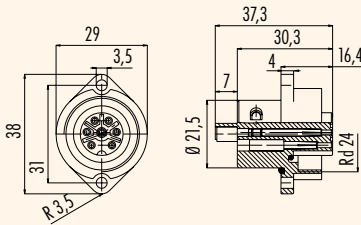

Bestell-Nr.  
Ordering-No.

Polzahl Contacts	Bestell-Nr. Ordering-No.
6+PE	09-0220-00-07

Polzahl Contacts	Bestell-Nr. Ordering-No.
6+PE	09-4220-00-07

Technische Daten  
Specifications

Polzahl	6+PE	Number of contacts
Steckverbinder Verriegelung	schrauben/screw	Connector locking system
Anschlussart	schrauben/screw	Termination
Anschlussquerschnitt	0,34-1,5 mm <sup>2</sup> (AWG 22-16)	Wire gauge
Kabeldurchlass	-	Cable outlet
Schutzart	IP67	Degree of protection
Mechanische Lebensdauer	> 500 Steckzyklen/> 500 mating cycles	Mechanical operation
Obere Grenztemperatur	+ 100 °C	Upper temperature
Untere Grenztemperatur	- 40 °C	Lower temperature
Bemessungsspannung	250 V	Rated voltage
Bemessungs-Stoßspannung	4000 V	Rated impulse voltage
Verschmutzungsgrad	3	Pollution degree
Überspannungskategorie	III	Overvoltage categorie
Isolierstoffgruppe	III	Material group
Bemessungsstrom (40°C)	10 A (8 A UL)	Rated current (40 °C)
Durchgangswiderstand	≤ 3 mΩ	Contact resistance
Material Kontakt	CuSn (Bronze/bronze)	Material of contact
Kontaktoberfläche	Ag (Silber/silver)	Contact plating
Material Kontaktkörper	PBT	Material of contact body
Material Gehäuse	-	Material of housing

## Maschinensteckverbinder Serie 692 - 693

### Connectors for machines series 692 - 693

Bezeichnung  
Description

Abbildung  
Figure

Flanschdose 6+PE, **Crimpschluss**  
Female socket 6+PE, **crimp termination**

Crimpkontakte siehe Seite 27.  
Crimp contacts see page 27.



Flanschdose 6+PE, **Crimpschluss**  
**VDE, SEV, UL Zulassung**  
Female socket 6+PE, **crimp termination**  
**VDE, SEV, UL approval**

Crimpkontakte siehe Seite 27.  
Crimp contacts see page 27.



Maßzeichnung  
Drawing

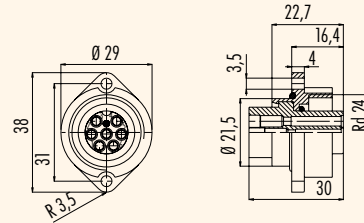
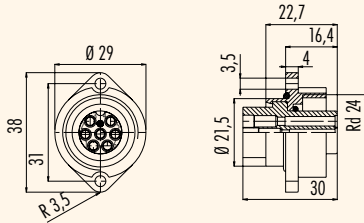

Bestell-Nr.  
Ordering-No.

Polzahl Contacts	Bestell-Nr. Ordering-No.
6+PE	09-0204-00-07

Polzahl Contacts	Bestell-Nr. Ordering-No.
6+PE	09-4204-00-07

Technische Daten  
Specifications

Polzahl	6+PE	Number of contacts
Steckverbinder Verriegelung	Schrauben/Screw	Connector locking system
Anschlussart	Crimpen/Crimp	Termination
Anschlussquerschnitt	0,14-1,5 mm <sup>2</sup> (AWG 26-16)	Wire gauge
Kabeldurchlass	-	Cable outlet
Schutzart	IP67	Degree of protection
Mechanische Lebensdauer	> 500 Steckzyklen/> 500 mating cycles	Mechanical operation
Obere Grenztemperatur	+ 100 °C	Upper temperature
Untere Grenztemperatur	- 40 °C	Lower temperature
Bemessungsspannung	250 V	Rated voltage
Bemessungs-Stoßspannung	4000 V	Rated impulse voltage
Verschmutzungsgrad	3	Pollution degree
Überspannungskategorie	III	Overvoltage categorie
Isolierstoffgruppe	III	Material group
Bemessungsstrom (40°C)	10 A (8 A UL)	Rated current (40 °C)
Durchgangswiderstand	≤ 3 mΩ	Contact resistance
Material Kontakt	CuSn (Bronze/bronze)	Material at contact
Kontaktoberfläche	Ag (Silber/silver)	Contact plating
Material Kontaktkörper	PBT	Material of contact body
Material Gehäuse	-	Material of housing

**Maschinensteckverbinder Serie 692 - 693**  
**Connectors for machines series 692 - 693**

Einzelteildarstellung  
 Component part drawing

**Kabelsteckverbinder**  
 Cable connectors

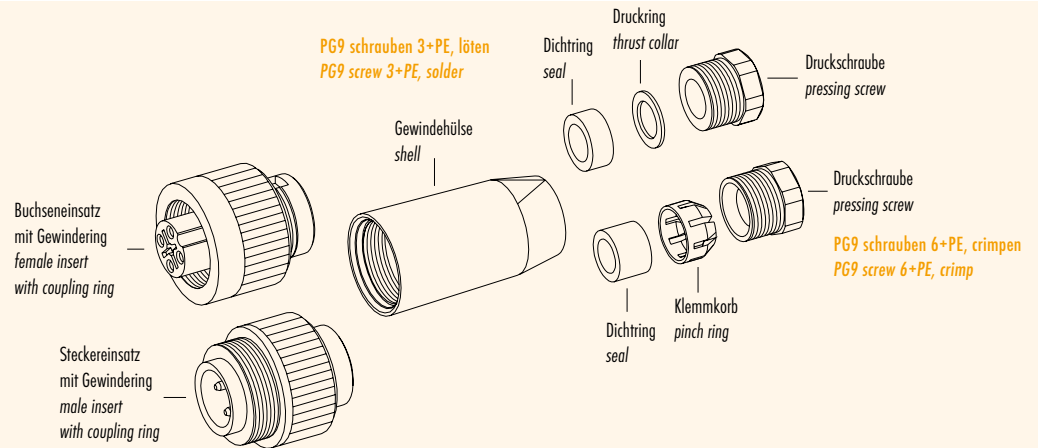

**Kabelsteckverbinder mit Kabelzugentlastung PG9 Version UL, VDE, SEV (schrauben 3+PE, löten)**  
 Cable connectors with cable clamp PG9 version UL, VDE, SEV (screw 3+PE, solder)

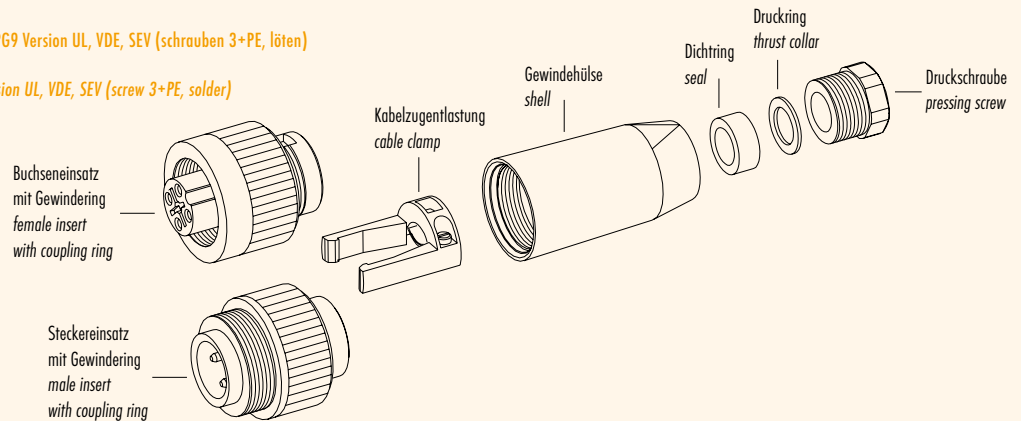

**Kabelsteckverbinder mit Klemmkorb PG11-, PG13,5-, PG16 Version**  
 Cable connectors with pinch ring PG11-, PG13,5-, PG16 version

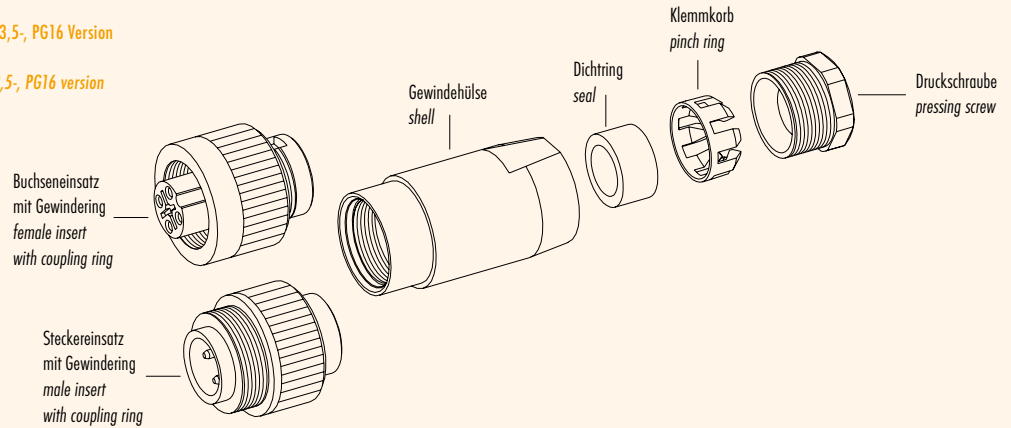

**Winkelsteckverbinder**  
 Angled connectors

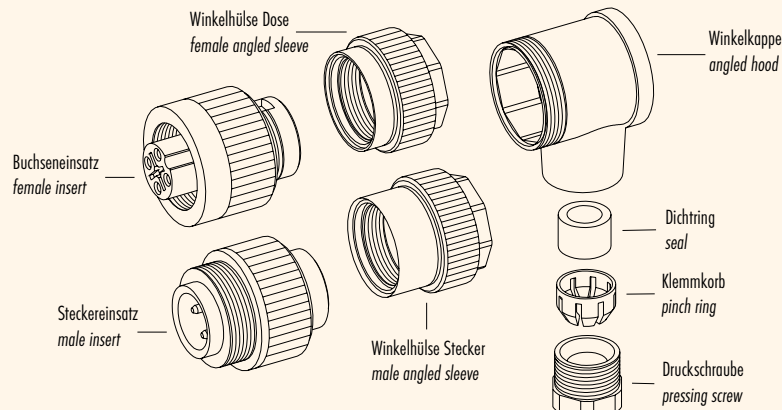

**Maschinensteckverbinder Serie 692 - 693**  
**Connectors for machines series 692 - 693**

Technische Daten Specifications of	Standard Kabel standard cable	
Polzahl	4	Contacts
Querschnitt mm <sup>2</sup> <sup>1)</sup>	4 x 1,5 mm <sup>2</sup>	Wire gauge mm <sup>2</sup> <sup>1)</sup>
Material Mantel	PVC schwarz / black	Material jacket
Isolation Litze	PVC sw 1, sw 2, sw 3, grün/gelb / bl 1, bl 2, bl 3, bl 4, green/yellow	Insulation wire
Litzenaufbau (mm)	28 x 0,25	Design of wire (mm)
Kabelmantel (mm)	8,6	Cable jacket (mm)
Leiterwiderstand	-	Resistance of wire
Temperaturbereich (Kabel bewegt)	- 5 °C / + 80 °C	Temperature range (cable in move)
Temperaturbereich (Kabel fest)	- 20 °C / + 80 °C	Temperature range (cable not in move)
Biegeradius (Kabel bewegt)	60 mm	Bending radius (cable in move)
Biegeradius (Kabel fest)	120 mm	Bending radius (cable not in move)
Zulassung	UL, CSA	Approval

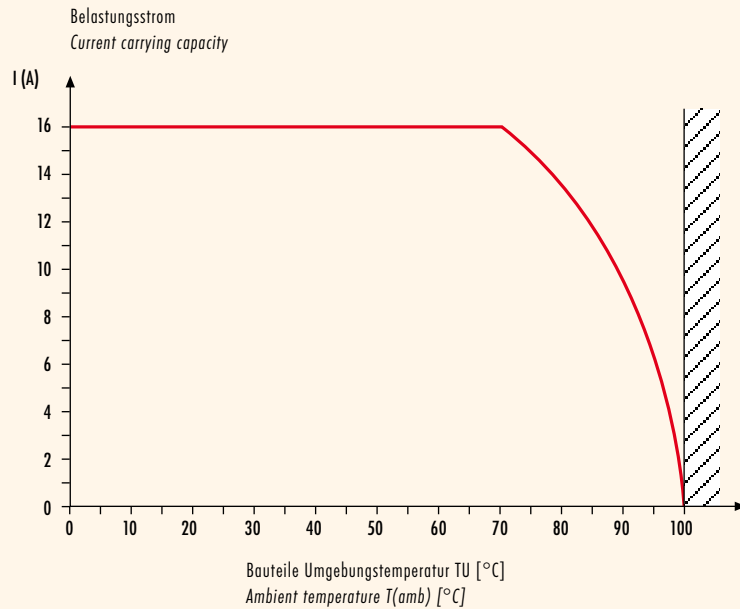
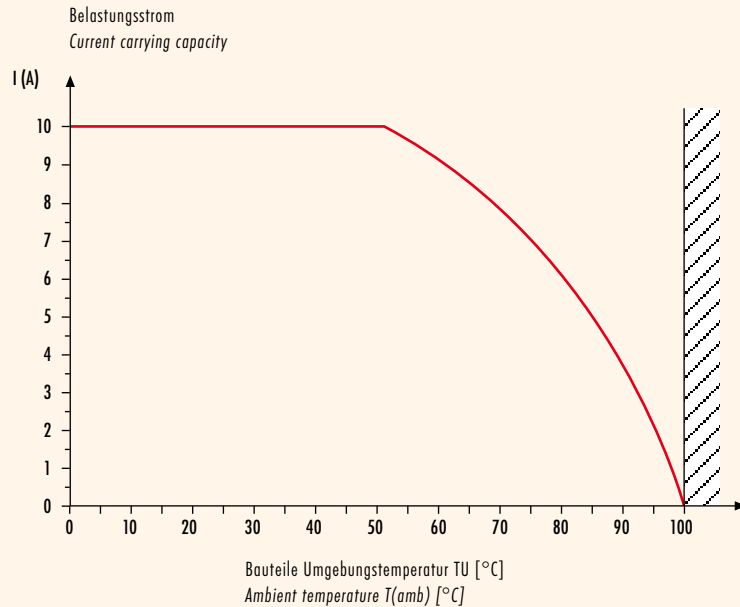
**Kennlinien  
Ratings**
**Strombelastbarkeitskurve 3+PE**  
**Derating curve 3+PE**

**Strombelastbarkeitskurve 6+PE**  
**Derating curve 6+PE**

<sup>1)</sup> Vergleichbare AWG Leiter siehe Seite TI-5. / <sup>1)</sup> Comparable AWG conductors see page TI-5.



**Maschinensteckverbinder Serie 692 - 693**  
**Connectors for machines series 692 - 693**
**Polbilder**  
*Contact arrangements*
**Stifteinsatz (Steckseite)**  
*Male insert (mating side)*
**Buchseinsatz (Steckseite)**  
*Female insert (mating side)*
**1+PE pol**  
*1+PE contacts*



	X	Y
1	-3,18	-3,18
PE	3,18	-3,18



	X	Y
1	3,18	-3,18
PE	-3,18	-3,18

**2+PE pol**  
*2+PE contacts*

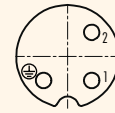

	X	Y
1	-3,18	-3,18
2	-3,18	3,18
PE	3,18	-3,18



	X	Y
1	3,18	-3,18
2	3,18	3,18
PE	-3,18	-3,18

**3+PE pol**  
*3+PE contacts*

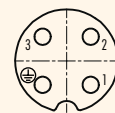

	X	Y
1	-3,18	-3,18
2	-3,18	3,18
3	3,18	3,18
PE	3,18	-3,18



	X	Y
1	3,18	-3,18
2	3,18	3,18
3	-3,18	3,18
PE	-3,18	-3,18

**6+PE pol**  
*6+PE contacts*

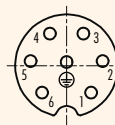
	X	Y
1	-3,25	-3,54
2	-4,76	0,63
3	-2,22	4,26
4	2,22	4,26
5	4,76	0,63
6	3,25	-3,54
PE	0,00	0,50





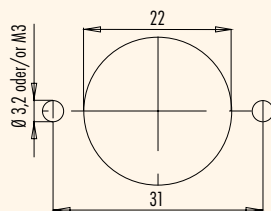





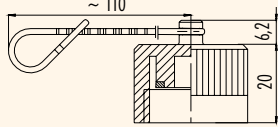
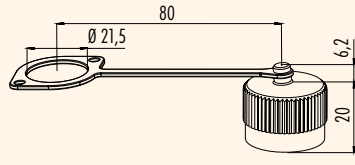
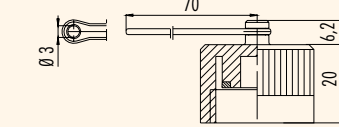

	X	Y
1	3,25	-3,54
2	4,76	0,63
3	2,22	4,26
4	-2,22	4,26
5	-4,76	0,63
6	-3,25	-3,54
PE	0,00	0,50

**Montageausschnitt**  
*Panel cut out*

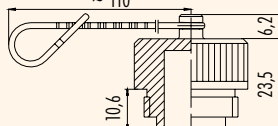
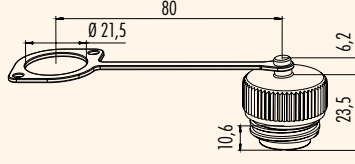
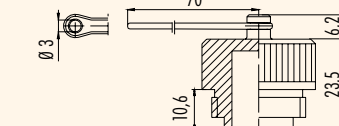
**Maschinensteckverbinder Serie 692 - 693**  
**Connectors for machines series 692 - 693**

**Zubehör**  
**Accessories**

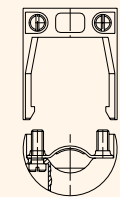
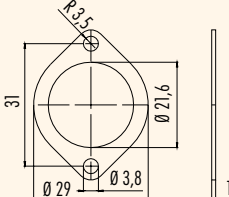
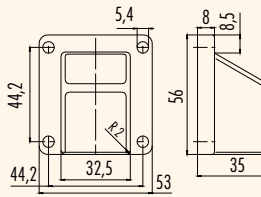
<p><b>Bezeichnung</b> Description</p>	<p>Schutzkappe für Kabelstecker, IP 67 Protection cap for male cable connector, IP 67</p>	<p>Schutzkappe für Flanschstecker, IP 67 Protection cap for male socket, IP 67</p>	<p>Schutzkappe für Flanschstecker, IP 67 Protection cap for male socket, IP 67</p>
<p><b>Abbildung</b> Figure</p>			
<p><b>Maßzeichnung</b> Drawing</p>			
<p><b>Bestell-Nr.</b> Ordering-No.</p>	<p>Bestell-Nr. Ordering-No. 08-2299-000-000</p>	<p>Bestell-Nr. Ordering-No. 08-2672-000-000</p>	<p>Bestell-Nr. Ordering-No. 08-2301-000-000</p>
<p><b>Bezeichnung</b> Description</p>	<p>Schutzkappe für Kabeldose, IP 67 Protection cap for female cable connector, IP 67</p>	<p>Schutzkappe für Flanschdose, IP 67 Protection cap for female socket, IP 67</p>	<p>Schutzkappe für Flanschdose, IP 67 Protection cap for female socket, IP 67</p>
<p><b>Abbildung</b> Figure</p>			
<p><b>Maßzeichnung</b> Drawing</p>			
<p><b>Bestell-Nr.</b> Ordering-No.</p>	<p>Bestell-Nr. Ordering-No. 08-2300-000-000</p>	<p>Bestell-Nr. Ordering-No. 08-2673-000-000</p>	<p>Bestell-Nr. Ordering-No. 08-2302-000-000</p>
<p><b>Bezeichnung</b> Description</p>	<p>Zugentlastung Cable clamp</p>	<p>Flachdichtung für Flanschsteckverbinder Flat seal for sockets</p>	<p>Anbaugehäuse Bulkhead housing</p>
<p><b>Abbildung</b> Figure</p>			
<p><b>Maßzeichnung</b> Drawing</p>			
<p><b>Bestell-Nr.</b> Ordering-No.</p>	<p>Bestell-Nr. Ordering-No. 08-0628-000-000</p>	<p>Bestell-Nr. Ordering-No. 04-0722-000</p>	<p>Bestell-Nr. Ordering-No. 16-0566-00-00</p>

**Maschinensteckverbinder Serie 692 - 693**  
**Connectors for machines series 692 - 693**
**Zubehör**  
**Accessories**

<b>Bezeichnung</b> <i>Description</i>  <b>Abbildung</b> <i>Figure</i>	Schutzkappe für Anschlussseite, Flanschsteckverbinder mit Schraubanschluss <i>Protection cap - screw termination side for socket</i>  	Stiftkontakt (VE=100 Stck.) <i>Male contact (PU=100 pcs)</i>  	Buchsenkontakt (VE=100 Stck.) <i>Female contact (PU=100 pcs)</i>  																																																				
<b>Maßzeichnung</b> <i>Drawing</i>																																																							
<b>Bestell-Nr.</b> <i>Ordering-No.</i>	Bestell-Nr. <i>Ordering-No.</i>  16-0565-00-00	<table border="1"> <thead> <tr> <th>A</th> <th>B</th> <th>Für Leiterquerschnitt for wire gauge</th> <th>AWG</th> <th>Bestell-Nr. Ordering-No.</th> </tr> </thead> <tbody> <tr> <td>0,9</td> <td>2,6</td> <td>0,14-0,34 mm<sup>2</sup></td> <td>26-22</td> <td>61-0891-139</td> </tr> <tr> <td>1,1</td> <td>2,6</td> <td>0,5 mm<sup>2</sup></td> <td>20</td> <td>61-0892-139</td> </tr> <tr> <td>1,45</td> <td>2,6</td> <td>0,75-1 mm<sup>2</sup></td> <td>18</td> <td>61-0893-139</td> </tr> <tr> <td>1,8</td> <td>3,0</td> <td>1,5 mm<sup>2</sup></td> <td>16</td> <td>61-0894-139</td> </tr> </tbody> </table>		A	B	Für Leiterquerschnitt for wire gauge	AWG	Bestell-Nr. Ordering-No.	0,9	2,6	0,14-0,34 mm <sup>2</sup>	26-22	61-0891-139	1,1	2,6	0,5 mm <sup>2</sup>	20	61-0892-139	1,45	2,6	0,75-1 mm <sup>2</sup>	18	61-0893-139	1,8	3,0	1,5 mm <sup>2</sup>	16	61-0894-139	<table border="1"> <thead> <tr> <th>A</th> <th>B</th> <th>Für Leiterquerschnitt for wire gauge</th> <th>AWG</th> <th>Bestell-Nr. Ordering-No.</th> </tr> </thead> <tbody> <tr> <td>0,9</td> <td>2,6</td> <td>0,14-0,34 mm<sup>2</sup></td> <td>26-22</td> <td>61-0896-139</td> </tr> <tr> <td>1,1</td> <td>2,6</td> <td>0,5 mm<sup>2</sup></td> <td>20</td> <td>61-0897-139</td> </tr> <tr> <td>1,45</td> <td>2,6</td> <td>0,75-1 mm<sup>2</sup></td> <td>18</td> <td>61-0898-139</td> </tr> <tr> <td>1,8</td> <td>3,0</td> <td>1,5 mm<sup>2</sup></td> <td>16</td> <td>61-0899-139</td> </tr> </tbody> </table>		A	B	Für Leiterquerschnitt for wire gauge	AWG	Bestell-Nr. Ordering-No.	0,9	2,6	0,14-0,34 mm <sup>2</sup>	26-22	61-0896-139	1,1	2,6	0,5 mm <sup>2</sup>	20	61-0897-139	1,45	2,6	0,75-1 mm <sup>2</sup>	18	61-0898-139	1,8	3,0	1,5 mm <sup>2</sup>	16	61-0899-139
A	B	Für Leiterquerschnitt for wire gauge	AWG	Bestell-Nr. Ordering-No.																																																			
0,9	2,6	0,14-0,34 mm <sup>2</sup>	26-22	61-0891-139																																																			
1,1	2,6	0,5 mm <sup>2</sup>	20	61-0892-139																																																			
1,45	2,6	0,75-1 mm <sup>2</sup>	18	61-0893-139																																																			
1,8	3,0	1,5 mm <sup>2</sup>	16	61-0894-139																																																			
A	B	Für Leiterquerschnitt for wire gauge	AWG	Bestell-Nr. Ordering-No.																																																			
0,9	2,6	0,14-0,34 mm <sup>2</sup>	26-22	61-0896-139																																																			
1,1	2,6	0,5 mm <sup>2</sup>	20	61-0897-139																																																			
1,45	2,6	0,75-1 mm <sup>2</sup>	18	61-0898-139																																																			
1,8	3,0	1,5 mm <sup>2</sup>	16	61-0899-139																																																			
<b>Bezeichnung</b> <i>Description</i>  <b>Abbildung</b> <i>Figure</i>	Crimpzange für gedrehte Crimpkontakte <i>Hand crimping tool for turned crimp contacts</i>  	Lösewerkzeug für Kontakte <i>Removal tool for contacts</i>  																																																					
<b>Bestell-Nr.</b> <i>Ordering-No.</i>	Bestell-Nr. <i>Ordering-No.</i>  66-0003-001	Bestell-Nr. <i>Ordering-No.</i>  66-0004-001																																																					

Maschinensteckverbinder Serie 692 - 693  
Connectors for machines series 692 - 693

Notizen  
Notes

Large blank area with horizontal lines for notes.

- ü
- Ti
- SI IP40
- SI IP67
- Bejonett
- PP IP67
- M9 IP40
- M9 IP67
- SI IP67
- Bejonett
- PP IP67
- M16 IP40
- M16 IP67
- M23
- Bejonett
- M25
- RD24
- RD30
- M5
- M8
- M12-A
- VL
- M12 PP
- Verteiler
- M12-B
- M12-D
- M12-US
- M18
- 7/8"
- BF-A
- BF-B
- BF-C
- R