

Miniatur Rundsteckverbinder Serie 423 Miniature circular connectors series 423

Kurzinformation Brief information

Kabelsteckverbinder

- Steckverbinder mit Schraubverriegelung nach IEC 130-9
- Schutzart IP 67¹⁾
- Robuste Metallbauweise
- Sehr gute EMV Eigenschaften (360° Schutz bei Schirmring Version)
- Innenliegende Zugentlastung
- Ausführungen mit Schirmringen oder mit Kabelklemme
- Winkelsteckverbinder in 4 Winkelpositionen einstellbar

Cable Connector

- Connector with screw locking according to IEC 130-9
- Degree of protection IP 67¹⁾
- Precision metal construction
- Excellent EMC shielding (versions with shielding rings 360°)
- Internal strain relief
- Versions with shielding rings or cable clamp
- Angled connector adjustable in 4 angled positions

Aufbau des Steckverbinders:
Construction of the connector:

Version mit Schirmringen
Version with shielding rings

Version mit Kabelklemme
Version with cable clamp

Winkelsteckverbinder
Angled connector

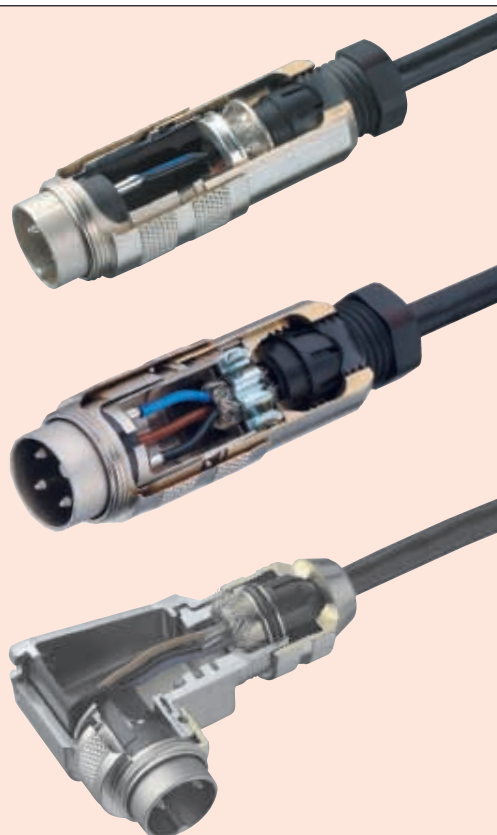

Flanschsteckverbinder

- 1 Standard: mit Lötanschluss, wird von vorn eingesetzt und von hinten verschraubt.
- 2 Mit Lötanschluss für die Verschraubung von vorne. Besonders geeignet für vorkonfektionierte Kabelbäume, die nach dem Lötén eingebaut werden.
- 3 Mit Tauchlötanschluss für den Anschluss auf die Leiterplatte (Abbildung vor dem Einbau in das Gehäuse).
- 4 Mit Tauchlötanschluss nach der Gehäusemontage.

Chassis sockets

- 1 Standard, with solder termination, mounted from front side and fastened from back side.
- 2 With solder termination, mounted from back side and fastened from front side, especially suited for preassembled cable trees which are mounted after soldering.
- 3 Dip solder termination for connection to PCB (figure: before built in into housing).
- 4 Dip solder termination after installation into housing.

1

2

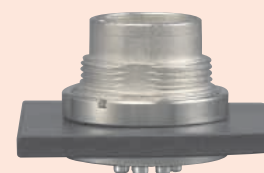
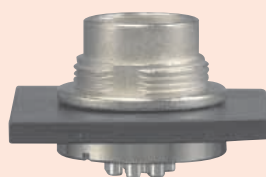

3

4

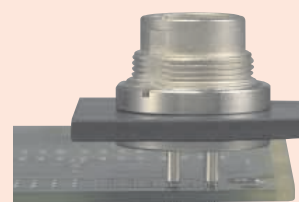
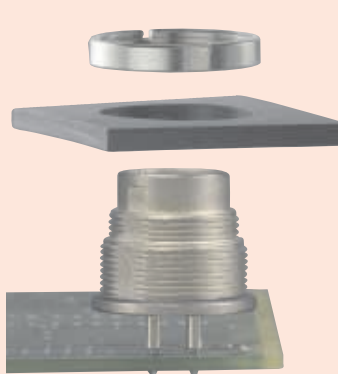







¹⁾ Erläuterung der Schutzarten siehe Seite TI-3 – TI-4. / ¹⁾ Explanation of protection standards see page TI-3 – TI-4.

Miniatur Rundsteckverbinder Serie 423 Miniature circular connectors series 423		Technische Daten ¹⁾ Specifications ¹⁾												
Allgemeine Kennwerte		General Characteristics												
Polzahl	Number of contacts	2	3 DIN	4	5	5 DIN	6 DIN	7	7 DIN	8 DIN	12	14	19	24
Verriegelung	Locking system	schrauben / screw												
Anschlussart	Termination	löten, tauchlöten / solder, dip solder												
Anschlussquerschnitt in mm ²	Wire gauge in mm ²	max. 0,75									max. 0,25		0,14	
Anschlussquerschnitt in AWG	Wire gauge in AWG	max. 20									max. 24		26	
Kabeldurchlass	Cable outlet	4 - 6 mm (PG 7) [.16 - .24] / 6 - 8 mm (PG 9) [.24 - .32]												
Schutzart Gehäuse	Shell protection	IP 67												
Mechanische Lebensdauer	Mechanical operation	> 500 Steckzyklen / > 500 mating cycles												
Obere Grenztemperatur	Upper temperature	+ 95 °C (+ 203 °F)												
Untere Grenztemperatur	Lower temperature	- 30 °C (- 22 °F)												
Gewicht Kabelsteckverbinder	Weight cable connector	~ 40 g (gerade/straight) / ~65 g (gewinkelt/angled)												
Gewicht Flanschsteckverbinder	Weight socket	~ 12 g												
Elektrische Kennwerte		Electrical Characteristics												
Bemessungsspannung	Rated voltage	250 V			60 V		125 V			60 V				
Bemessungsstoßspannung	Rated impulse voltage	1500 V			500 V		800 V			500 V				
Verschmutzungsgrad	Pollution degree	1												
Überspannungskategorie	Overvoltage categorie	I												
Isolierstoffgruppe	Material group	III												
Prüfstoßspannung	Test voltage	1750 V			550 V		910 V			550 V				
Bemessungsstrom (40 °C)	Rated current (40 °C)	7 A		6 A			5 A			3 A		1 A		
Durchgangswiderstand	Contact resistance	≤ 5 mΩ									≤ 3 mΩ			
Isolationswiderstand	Insulation resistance	≥ 10 ¹⁰ Ω												
Werkstoffe		Materials												
Kontaktstift	Pin contact	CuZn (Messing/brass)												
Kontaktbuchse	Socket contact	CuSn (Bronze/bronze)												
Kontaktoberfläche	Contact plating	Ag (Silber/silver) / Au (Gold/gold)									Au (Gold/gold)			
Steckerkörper	Male insert	PBT (UL 94 V-0)												
Buchsenkörper	Female Insert	PBT (UL 94 V-0)												
Gehäuse Kabelstecker gerade	Housing straight cable connector	CuZn (Messing, vernickelt/brass, nickel plated)												
Gehäuse Kabelstecker gewinkelt	Housing angled cable connector	Zink-Druckguss, vernickelt/zinc diecasting, nickel plated												
Flanschgehäuse	Socket	Zink-Druckguss, vernickelt/zinc diecasting, nickel plated												

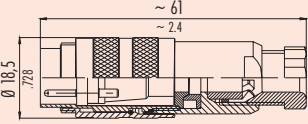
¹⁾ Normen und Prüfbedingungen für diese Angaben siehe Seite TI-16. / Standards and test parameters for this data see page TI-16.

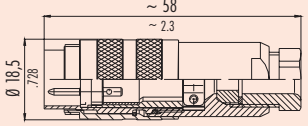

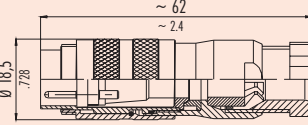

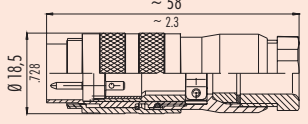

Miniatur Rundsteckverbinder Serie 423 Miniature circular connectors series 423

Kabelstecker Male cable connectors

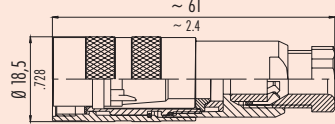
Bezeichnung – Abbildung Description – Figure	Maßzeichnung Drawing	Polzahl Contacts	Bestell-Nr./Ordering-No.	
			versilberte Kontakte silver plated contacts	vergoldete Kontakte gold plated contacts
Kabelstecker mit Schirmring Kabeldurchlass 4 - 6 mm <i>Male cable connector with shielding ring cable outlet 4 - 6 mm (.16 - .24 in.)</i> 		2	99-5101-15-02	99-5101-19-02
		3 DIN	99-5105-15-03	99-5105-19-03
		4	99-5109-15-04	99-5109-19-04
		5	99-5113-15-05	99-5113-19-05
		5 (Stereo)	99-5117-15-05	99-5117-19-05
		6 DIN	99-5121-15-06	99-5121-19-06
		7	99-5125-15-07	99-5125-19-07
		7 DIN	99-5181-15-07	–
		8 DIN	99-5171-15-08	99-5171-19-08
		12	–	99-5129-15-12
		14	–	99-5451-15-14
		19	–	99-5461-15-19
		24	–	99-5495-15-24
Kabelstecker mit Kabelklemme Kabeldurchlass 4 - 6 mm <i>Male cable connector with cable clamp cable outlet 4 - 6 mm (.16 - .24 in.)</i> 		2	99-5101-00-02	99-5101-09-02
		3 DIN	99-5105-00-03	99-5105-09-03
		4	99-5109-00-04	99-5109-09-04
		5	99-5113-00-05	99-5113-09-05
		5 (Stereo)	99-5117-00-05	99-5117-09-05
		6 DIN	99-5121-00-06	99-5121-09-06
		7	99-5125-00-07	99-5125-09-07
		7 DIN	99-5181-00-07	–
		8 DIN	99-5171-00-08	99-5171-09-08
		12	–	99-5129-00-12
		14	–	99-5451-00-14
		19	–	99-5461-00-19
		24	–	99-5495-00-24
Kabelstecker mit Schirmring Kabeldurchlass 6 - 8 mm <i>Male cable connector with shielding ring cable outlet 6 - 8 mm (.24 - .32 in.)</i> 		2	99-5601-15-02	99-5601-19-02
		3 DIN	99-5605-15-03	99-5605-19-03
		4	99-5609-15-04	99-5609-19-04
		5	99-5613-15-05	99-5613-19-05
		5 (Stereo)	99-5617-15-05	99-5617-19-05
		6 DIN	99-5621-15-06	99-5621-19-06
		7	99-5625-15-07	99-5625-19-07
		7 DIN	99-5681-15-07	–
		8 DIN	99-5671-15-08	99-5671-19-08
		12	–	99-5629-15-12
		14	–	99-5651-15-14
		19	–	99-5661-15-19
		24	–	99-5695-15-24
Kabelstecker mit Kabelklemme Kabeldurchlass 6 - 8 mm <i>Male cable connector with cable clamp cable outlet 6 - 8 mm (.24 - .32 in.)</i> 		2	99-5601-00-02	99-5601-09-02
		3 DIN	99-5605-00-03	99-5605-09-03
		4	99-5609-00-04	99-5609-09-04
		5	99-5613-00-05	99-5613-09-05
		5 (Stereo)	99-5617-00-05	99-5617-09-05
		6 DIN	99-5621-00-06	99-5621-09-06
		7	99-5625-00-07	99-5625-09-07
		7 DIN	99-5681-00-07	–
		8 DIN	99-5671-00-08	99-5671-09-08
		12	–	99-5629-00-12
		14	–	99-5651-00-14
		19	–	99-5661-00-19
		24	–	99-5695-00-24

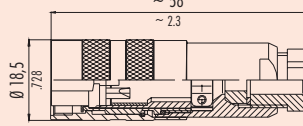

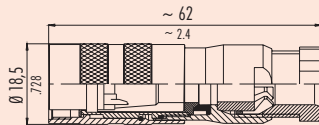

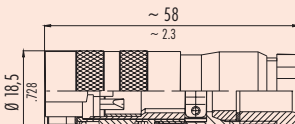

Miniatur Rundsteckverbinder Serie 423 Miniature circular connectors series 423



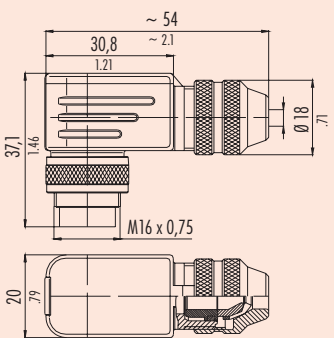

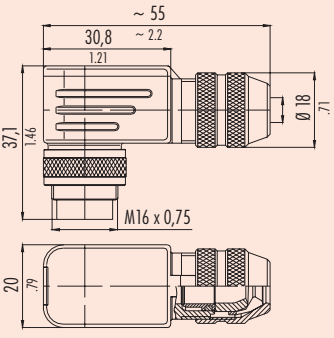

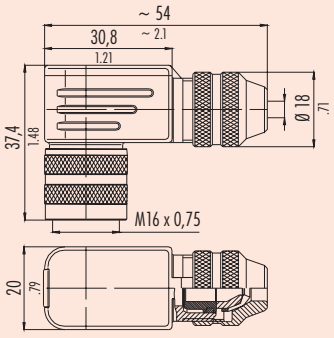
Kabel Dosen Female cable connectors

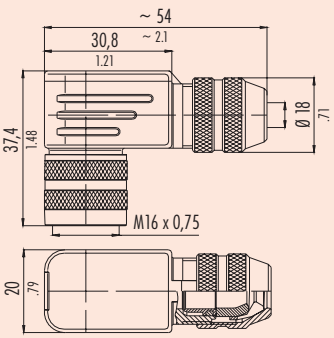
Bezeichnung — Abbildung Description — Figure	Maßzeichnung Drawing	Polzahl Contacts	Bestell-Nr./Ordering-No.	
			versilberte Kontakte silver plated contacts	vergoldete Kontakte gold plated contacts
Kabeldose mit Schirmring Kabeldurchlass 4 - 6 mm <i>Female cable connector with shielding ring cable outlet 4 - 6 mm (.16 - .24 in.)</i> 		2	99-5102-15-02	99-5102-19-02
		3 DIN	99-5106-15-03	99-5106-19-03
		4	99-5110-15-04	99-5110-19-04
		5	99-5114-15-05	99-5114-19-05
		5 (Stereo)	99-5118-15-05	99-5118-19-05
		6 DIN	99-5122-15-06	99-5122-19-06
		7	99-5126-15-07	99-5126-19-07
		7 DIN	99-5182-15-07	—
		8 DIN	99-5172-15-08	99-5172-19-08
		12	—	99-5130-15-12
		14	—	99-5452-15-14
		19	—	99-5462-15-19
		24	—	99-5496-15-24
		Kabeldose mit Kabelklemme Kabeldurchlass 4 - 6 mm <i>Female cable connector with cable clamp cable outlet 4 - 6 mm (.16 - .24 in.)</i> 		2
3 DIN	99-5106-00-03			99-5106-09-03
4	99-5110-00-04			99-5110-09-04
5	99-5114-00-05			99-5114-09-05
5 (Stereo)	99-5118-00-05			99-5118-09-05
6 DIN	99-5122-00-06			99-5122-09-06
7	99-5126-00-07			99-5126-09-07
7 DIN	99-5182-00-07			—
8 DIN	99-5172-00-08			99-5172-09-08
12	—			99-5130-00-12
14	—			99-5452-00-14
19	—			99-5462-00-19
24	—			99-5496-00-24
Kabeldose mit Schirmring Kabeldurchlass 6 - 8 mm <i>Female cable connector with shielding ring cable outlet 6 - 8 mm (.24 - .32 in.)</i> 				2
		3 DIN	99-5606-15-03	99-5606-19-03
		4	99-5610-15-04	99-5610-19-04
		5	99-5614-15-05	99-5614-19-05
		5 (Stereo)	99-5618-15-05	99-5618-19-05
		6 DIN	99-5622-15-06	99-5622-19-06
		7	99-5626-15-07	99-5626-19-07
		7 DIN	99-5682-15-07	—
		8 DIN	99-5672-15-08	99-5672-19-08
		12	—	99-5630-15-12
		14	—	99-5652-15-14
		19	—	99-5662-15-19
		24	—	99-5696-15-24
		Kabeldose mit Kabelklemme Kabeldurchlass 6 - 8 mm <i>Female cable connector with cable clamp cable outlet 6 - 8 mm (.24 - .32 in.)</i> 		2
3 DIN	99-5606-00-03			99-5606-09-03
4	99-5610-00-04			99-5610-09-04
5	99-5614-00-05			99-5614-09-05
5 (Stereo)	99-5618-00-05			99-5618-09-05
6 DIN	99-5622-00-06			99-5622-09-06
7	99-5626-00-07			99-5626-09-07
7 DIN	99-5682-00-07			—
8 DIN	99-5672-00-08			99-5672-09-08
12	—			99-5630-00-12
14	—			99-5652-00-14
19	—			99-5662-00-19
24	—			99-5696-00-24

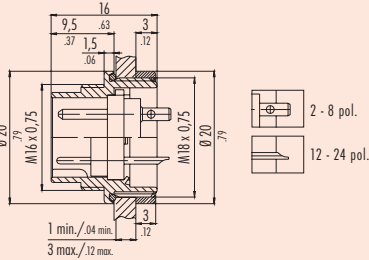

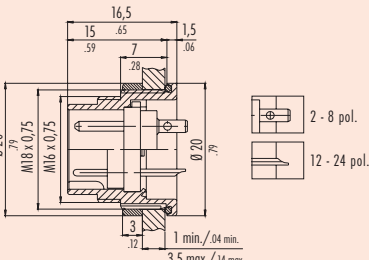

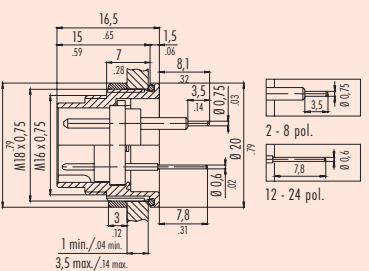

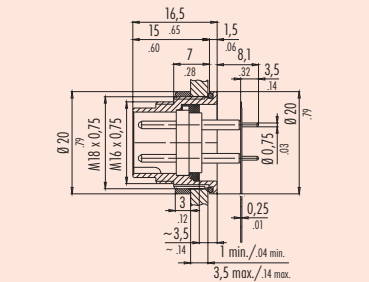
Miniatur Rundsteckverbinder Serie 423 Miniature circular connectors series 423

Winkelsteckverbinder Angled connectors

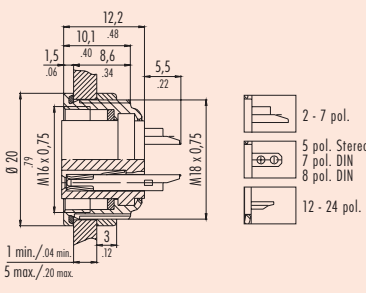
Bezeichnung – Abbildung Description – Figure	Maßzeichnung Drawing	Polzahl Contacts	Bestell-Nr./Ordering-No.	
			versilberte Kontakte silver plated contacts	vergoldete Kontakte gold plated contacts
Winkelstecker Kabeldurchlass 4 - 6 mm Male angled connector cable outlet 4 - 6 mm (.16 - .24 in.) 		2	99-5101-75-02	–
		3 DIN	99-5105-75-03	–
		4	99-5109-75-04	–
		5	99-5113-75-05	–
		5 (Stereo)	99-5117-75-05	–
		6 DIN	99-5121-75-06	–
		7	99-5125-75-07	–
		7 DIN	99-5181-75-07	–
		8 DIN	99-5171-75-08	–
		12	–	99-5129-75-12
14	–	99-5451-75-14		
19	–	99-5461-75-19		
24	–	99-5495-75-24		
Winkelstecker Kabeldurchlass 6 - 8 mm Male angled connector cable outlet 6 - 8 mm (.24 - .32 in.) 		2	99-5601-75-02	–
		3 DIN	99-5605-75-03	–
		4	99-5609-75-04	–
		5	99-5613-75-05	–
		5 (Stereo)	99-5617-75-05	–
		6 DIN	99-5621-75-06	–
		7	99-5625-75-07	–
		7 DIN	99-5681-75-07	–
		8 DIN	99-5671-75-08	–
		12	–	99-5629-75-12
14	–	99-5651-75-14		
19	–	99-5661-75-19		
24	–	99-5695-75-24		
Winkeldose Kabeldurchlass 4 - 6 mm Female angled connector cable outlet 4 - 6 mm (.16 - .24 in.) 		2	99-5102-75-02	–
		3 DIN	99-5106-75-03	–
		4	99-5110-75-04	–
		5	99-5114-75-05	–
		5 (Stereo)	99-5118-75-05	–
		6 DIN	99-5122-75-06	–
		7	99-5126-75-07	–
		7 DIN	99-5182-75-07	–
		8 DIN	99-5172-75-08	–
		12	–	99-5130-75-12
14	–	99-5452-75-14		
19	–	99-5462-75-19		
24	–	99-5496-75-24		
Winkeldose Kabeldurchlass 6 - 8 mm Female angled connector cable outlet 6 - 8 mm (.24 - .32 in.) 		2	99-5602-75-02	–
		3 DIN	99-5606-75-03	–
		4	99-5610-75-04	–
		5	99-5614-75-05	–
		5 (Stereo)	99-5618-75-05	–
		6 DIN	99-5622-75-06	–
		7	99-5626-75-07	–
		7 DIN	99-5682-75-07	–
		8 DIN	99-5672-75-08	–
		12	–	99-5630-75-12
14	–	99-5652-75-14		
19	–	99-5662-75-19		
24	–	99-5696-75-24		

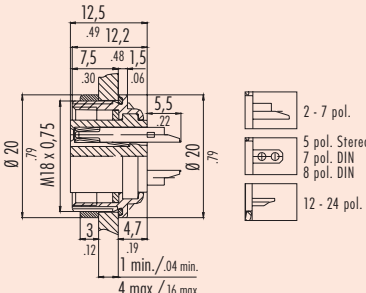

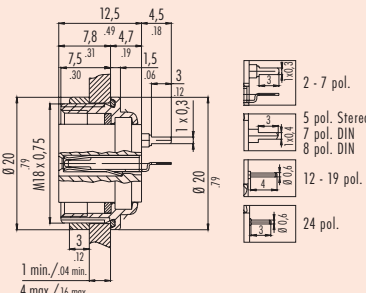

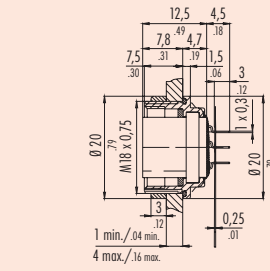





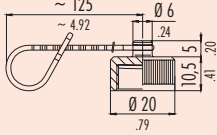

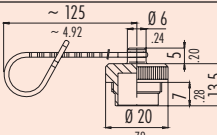

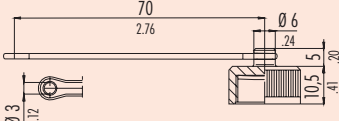

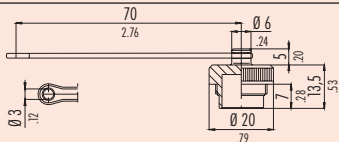

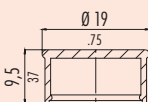

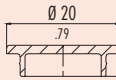

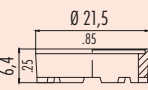
Miniatur Rundsteckverbinder Serie 423 Miniature circular connectors series 423		Flanschstecker Male sockets		
Bezeichnung — Abbildung Description — Figure	Maßzeichnung Drawing	Polzahl Contacts	Bestell-Nr./Ordering-No.	
			versilberte Kontakte silver plated contacts	vergoldete Kontakte gold plated contacts
Flanschstecker, löten Male socket, solder 		2	09-0103-00-02	09-0103-09-02
		3 DIN	09-0107-00-03	09-0107-09-03
		4	09-0111-00-04	09-0111-09-04
		5	09-0115-00-05	09-0115-09-05
		5 (Stereo)	09-0119-00-05	09-0119-09-05
		6 DIN	09-0123-00-06	09-0123-09-06
		7	09-0127-00-07	09-0127-09-07
		7 DIN	09-0583-00-07	—
		8 DIN	09-0173-00-08	09-0173-09-08
		12	—	09-0131-00-12
		14	—	09-0453-00-14
		19	—	09-0463-00-19
Flanschstecker, löten, von vorn verschraubbar Male socket, solder, front fastened 		2	09-0103-80-02	09-0103-89-02
		3 DIN	09-0107-80-03	09-0107-89-03
		4	09-0111-80-04	09-0111-89-04
		5	09-0115-80-05	09-0115-89-05
		5 (Stereo)	09-0119-80-05	09-0119-89-05
		6 DIN	09-0123-80-06	09-0123-89-06
		7	09-0127-80-07	09-0127-89-07
		7 DIN	—	—
		8 DIN	09-0173-80-08	09-0173-89-08
		12	—	09-0131-80-12
		14	—	09-0453-80-14
		19	—	09-0463-80-19
Flanschstecker, tauchlöten, von vorn verschraubbar Male socket, dip solder, front fastened 		2	09-0103-90-02	09-0103-99-02
		3 DIN	09-0107-90-03	09-0107-99-03
		4	09-0111-90-04	09-0111-99-04
		5	09-0115-90-05	09-0115-99-05
		5 (Stereo)	09-0119-90-05	09-0119-99-05
		6 DIN	09-0123-90-06	09-0123-99-06
		7	09-0127-90-07	09-0127-99-07
		7 DIN	—	—
		8 DIN	09-0173-90-08	09-0173-99-08
		12	—	09-0131-90-12
		14	—	09-0453-90-14
		19	—	09-0463-90-19
Flanschstecker mit Flexplatte, von vorn verschraubbar Male socket with flexible PCB, front fastened 	 <p>Weitere Maße siehe Seite 423-14 Additional dimensions see page 423-14</p>	7	09-0127-65-07	
		8	09-0173-65-08	
		12		09-0131-62-12
		12		09-0131-68-12

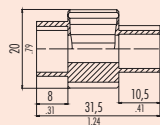
¹⁾ Flanschstecker von Serie 723 / Sockets from series 723.

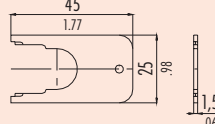
Miniatur Rundsteckverbinder Serie 423 Miniature circular connectors series 423		Flanschdosen Female sockets		
Bezeichnung – Abbildung Description – Figure	Maßzeichnung Drawing	Polzahl Contacts	Bestell-Nr./Ordering-No. versilberte Kontakte <i>silver plated contacts</i>	
			vergoldete Kontakte <i>gold plated contacts</i>	
Flanschdose, löten <i>Female socket, solder</i> 		2	09-0104-00-02	09-0104-09-02
		3 DIN	09-0108-00-03	09-0108-09-03
		4	09-0112-00-04	09-0112-09-04
		5	09-0116-00-05	09-0116-09-05
		5 (Stereo)	09-0120-00-05	09-0120-09-05
		6 DIN	09-0124-00-06	09-0124-09-06
		7	09-0128-00-07	09-0128-09-07
		7 DIN	09-0584-00-07	–
		8 DIN	09-0174-00-08	09-0174-09-08
		12	–	09-0132-00-12
		14	–	09-0454-00-14
		19	–	09-0464-00-19
Flanschdose, löten, von vorn verschraubbar <i>Female socket, solder, front fastened</i> 		2	09-0104-80-02	09-0104-89-02
		3 DIN	09-0108-80-03	09-0108-89-03
		4	09-0112-80-04	09-0112-89-04
		5	09-0116-80-05	09-0116-89-05
		5 (Stereo)	09-0120-80-05	09-0120-89-05
		6 DIN	09-0124-80-06	09-0124-89-06
		7	09-0128-80-07	09-0128-89-07
		7 DIN	–	–
		8 DIN	09-0174-80-08	09-0174-89-08
		12	–	09-0131-80-12
		14	–	09-0454-80-14
		19	–	09-0464-80-19
Flanschdose, tauchlöten, von vorn verschraubbar <i>Female socket, dip solder, front fastened</i> 		2	09-0104-90-02	09-0104-99-02
		3 DIN	09-0108-90-03	09-0108-99-03
		4	09-0112-90-04	09-0112-99-04
		5	09-0116-90-05	09-0116-99-05
		5 (Stereo)	09-0120-90-05	09-0120-99-05
		6 DIN	09-0124-90-06	09-0124-99-06
		7	09-0128-90-07	09-0128-99-07
		7 DIN	–	–
		8 DIN	09-0174-90-08	09-0174-99-08
		12	–	09-0132-90-12
		14	–	09-0454-90-14
		19	–	09-0464-90-19
Flanschdose mit Flexplatte, von vorn verschraubbar <i>Female socket with flex board, front fastened</i> 		7	09-0128-65-07	
		8	09-0174-65-08	
		12		09-0132-65-12
		12		09-0132-66-12

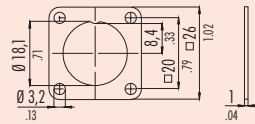
Weitere Maße siehe Seite 423-14
 Additional dimensions see page 423-14

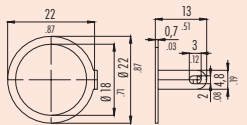
¹⁾ Flanschstecker von Serie 723 / Sockets from series 723.

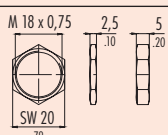
Miniatur Rundsteckverbinder Serie 423 Miniature circular connectors series 423		Zubehör Accessories	
Bezeichnung Description	Abbildung Figure	Maßzeichnung Drawing	Bestell-Nr. Ordering-No.
Schutzkappe für Kabelstecker, wasserdicht, IP 67 <i>Protection cap for male cable connector, waterproof, IP 67</i>			08-1077-000-000
Schutzkappe für Kabeldose, wasserdicht, IP 67 <i>Protection cap for female cable connector, waterproof, IP 67</i>			08-1078-000-000
Schutzkappe für Flanschstecker, wasserdicht, IP 67 <i>Protection cap for male socket, waterproof, IP 67</i>			08-1079-000-000
Schutzkappe für Flanschdose, wasserdicht, IP 67 <i>Protection cap for female socket, waterproof, IP 67</i>			08-1080-000-000
Schutzkappe für Kabel- und Flanschstecker, staubdicht, IP 54 <i>Protection cap for male cable connector and male socket, dustproof, IP 54</i>			02-0054-000
Schutzkappe für Kabel- und Flanschdose, staubdicht, IP 54 <i>Protection cap for female cable connector and female socket, dustproof, IP 54</i>			02-0055-001 02-0055-000 (Schwarz/black)
Distanzhülse für Flanschsteckverbinder, Tauchlöt Ausführung, 2-19 contacts <i>Distance shell for socket, dip solder version, 2-19 contacts</i>			02-0007-000
Montageschlüssel für Kabelsteckverbinder <i>Mounting spanner for cable connector</i>			02-1785-000
Montageschlüssel für Flanschsteckverbinder <i>Mounting spanner for socket</i>			07-0010-001
Viereckflansch für Flanschsteckverbinder <i>Rectangular flange for socket</i>			08-0045-000-001
Lötösenring (Schutzart kann sich verringern) <i>Solder eye ring (Protection standard may be reduce)</i>			04-0186-009
6-kant Mutter <i>Hexagonal nut</i>			01-0146-001 (2,5 mm/.10) 01-5006-001 (5 mm/.20)

Miniatur Rundsteckverbinder Serie 423 Miniature circular connectors series 423

Einzelteildarstellung Component part drawings

Kabelstecker
mit Schirmring
Male cable connector
with shielding ring

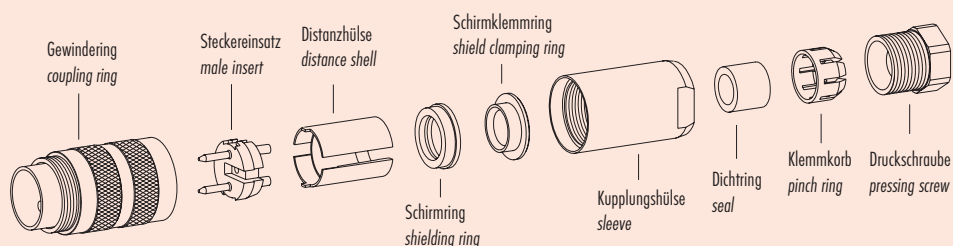

Kabelstecker
mit Kabelklemme
Male cable connector
with cable clamp

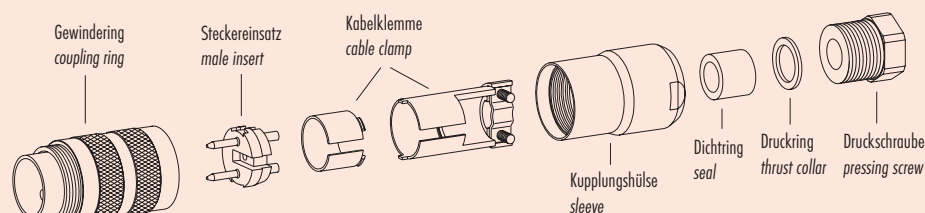

Kabeldose
mit Schirmring
Female cable connector
with shield ring

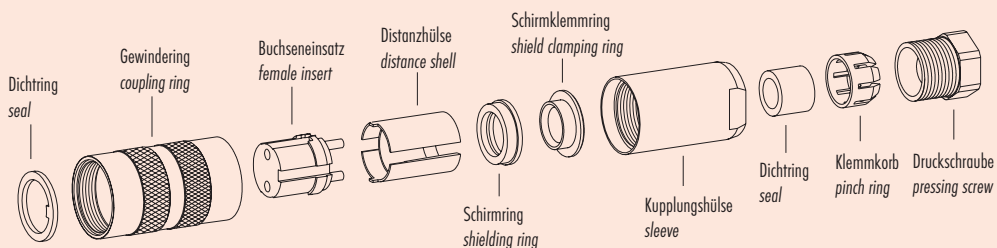

Kabeldose
mit Kabelklemme
Female cable connector
with cable clamp

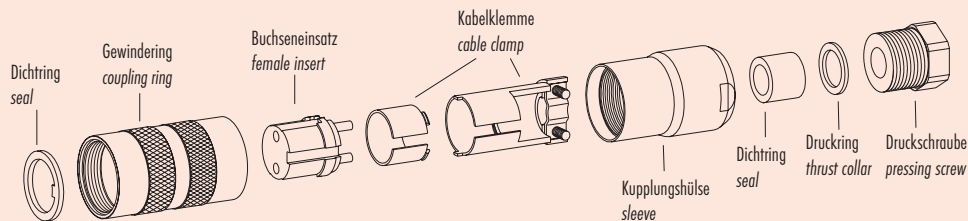

Winkelsteckverbinder
Angled connector

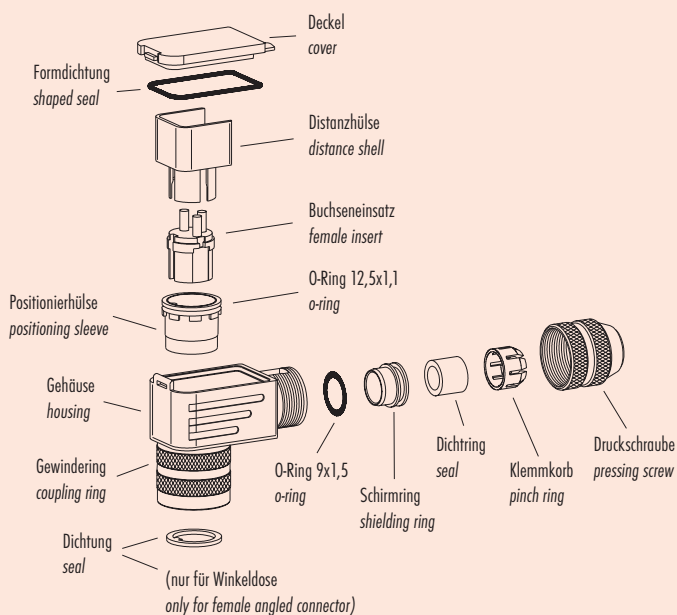

Miniatur Rundsteckverbinder Serie 423 Miniature circular connectors series 423

Montageanleitung Assembly instruction

Gerade Version

(Ausführung mit Schirmring)

1. Teile auffädeln
2. Abisolieren und Schirm aufweiten
3. Schirmklemmring montieren
4. Litze anlöten, Distanzhülse überschnappen
5. Überstehenden Schirm abschneiden
6. Übrige Teile gemäß Darstellung montieren

Straight version

(Version with shielding ring)

1. Stringing parts
2. Stripping and widening of shield
3. Assembling shield clamping ring
4. Soldering wire, tripping distance bush
5. Cutting off projecting shield
7. Assembling remaining parts according to plan

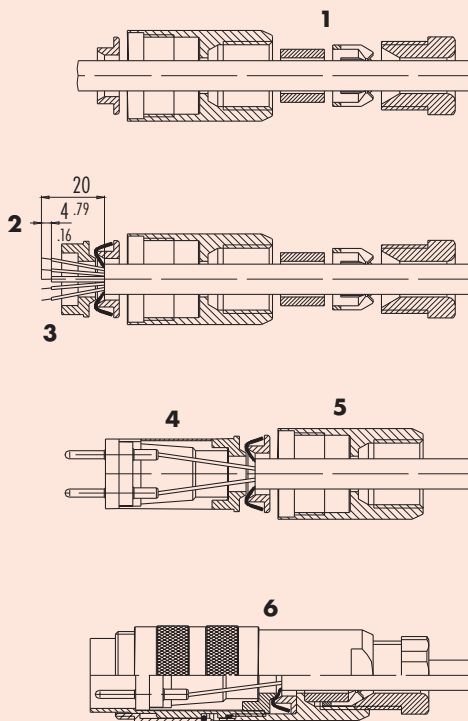

Winkelversion

1. Dichtungen montieren (3x)
2. Kabelteile auffädeln
3. Kabel und Schirm abmanteln
4. Litzen durch das Gehäuse fädeln
5. Schirmring, Klemmkorb montieren
6. Druckschraube leicht andrehen
7. Litzen an Kontakteinsatz löten
8. Verdrehhülse in Winkelstellung montieren
9. Kontakteinsatz, Distanzhülse einsetzen
10. Deckel einhaken
11. Druckschraube festziehen (ca. 10-20 Nm)

Angled version

1. Assembly of seal (3x)
2. Stringing cable parts
3. Dismantle cable and shield
4. Thread-up wires through the housing
5. Mount shielding ring and pinch ring
6. Turn on the pressing screw very slightly
7. Solder wires on insert
8. Mount torsion carrier sleeve in angled position
9. Set in insert and distance sleeve
10. Mount cover
11. Fix pressing screw (approx. 10-20 Nm)

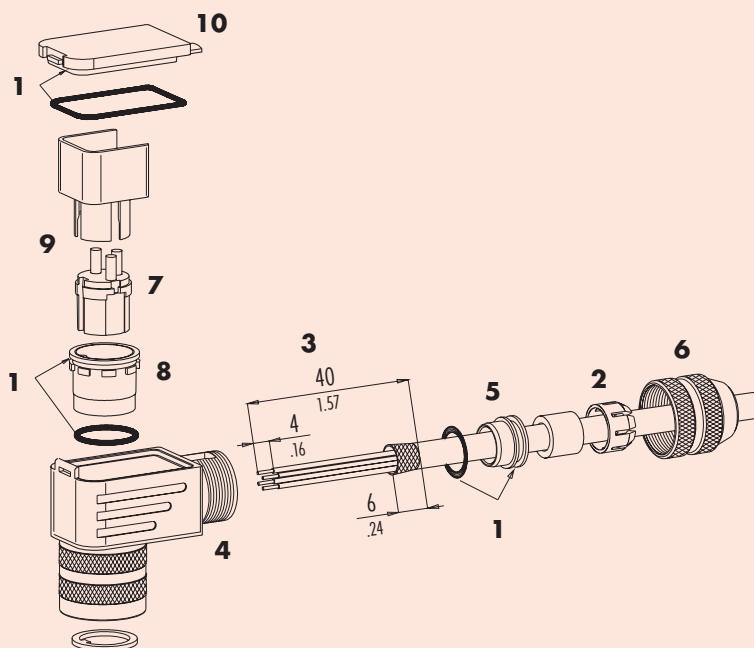

Miniatur Rundsteckverbinder Serie 423 Miniature circular connectors series 423

Polbilder Contact arrangements

Polbilder mit Sicht auf die Lötanschlussseite der Stifteinsätze
Contact arrangements with view on the solder termination side of male inserts

x-y Koordinaten
x-y Coordinates

2 pol

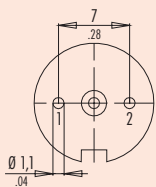

3 pol (DIN 41524)

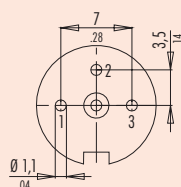

4 pol

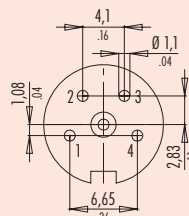

8 pol

	X	Y
1	-3,50	0,00
2	0,00	3,50
3	3,50	0,00
4	-2,47	2,47
5	2,47	2,47
6	-2,47	-2,47
7	2,47	-2,47
8	0,00	-0,70

5 pol

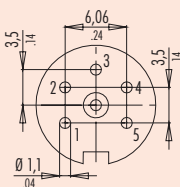

5 pol stereo (DIN 41524)

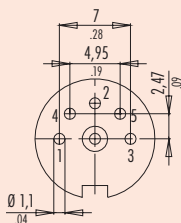

6 pol (DIN 45322)

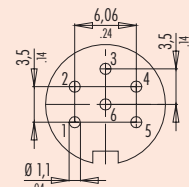

12 pol

	X	Y
A	-0,41	-3,45
B	2,29	-3,61
C	4,10	-1,21
D	3,20	1,34
E	2,71	3,59
F	0,41	3,45
G	-2,29	3,61
H	-4,10	1,21
J	-3,20	-1,34
K	-2,71	-3,59
L	-2,00	-1,51
M	-2,00	-1,51

7 pol

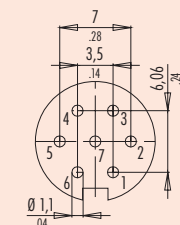

7 pol (DIN 45329)

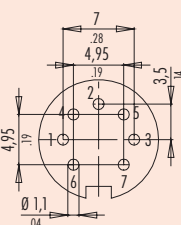

8 pol (DIN 45326)

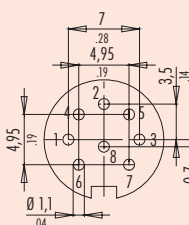

14 pol

	X	Y		X	Y
A	2,50	-4,00	T	-2,40	-0,95
C	4,25	0,00	U	-0,95	-2,40
E	2,30	4,00			
J	-4,25	0,00			
L	-2,50	-4,00			
M	0,95	-2,40			
N	2,40	-0,95			
O	2,40	0,95			
P	0,95	2,40			
R	-0,95	2,40			
S	-2,40	0,95			

12 pol

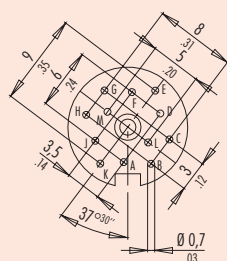

14 pol

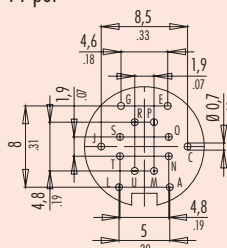

19 pol

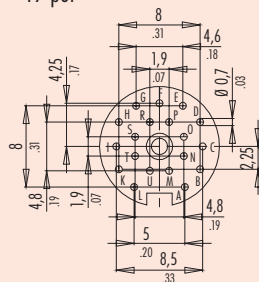

19 pol

	X	Y		X	Y
A	2,50	-4,00	N	2,40	-0,95
B	4,00	-2,25	O	2,40	0,95
C	4,25	0,00	P	0,95	2,40
D	4,00	2,40	R	-0,95	2,40
E	2,30	4,00	S	-2,40	0,95
F	0,00	4,25	T	-2,40	-0,95
G	-2,30	4,00	U	-0,95	-2,40
H	-4,00	2,40			
I	-4,25	0,00			
K	-4,00	-2,25			
L	-2,50	-4,00			
M	0,95	-2,40			

24 pol

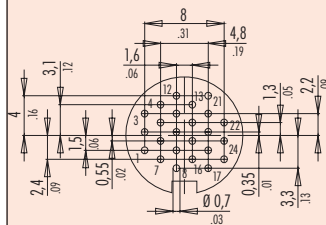

Montageausschnitt
Panel cut out

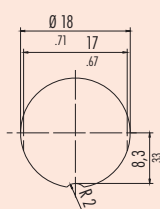

Empfohlene Bohrdurchmesser
Recommended drill hole

2-8 pol 1,1 mm (.043 in.)
12-24 pol 0,8 mm (.031 in.)

24 pol

	X	Y		X	Y
1	-4,00	-1,50	13	0,80	3,10
2	-4,00	0,35	14	0,80	1,30
3	-4,00	2,20	15	0,80	-0,55
4	-2,40	3,10	16	0,80	-2,40
5	-2,40	1,30	17	2,40	-3,30
6	-2,40	-0,55	18	2,40	-1,50
7	-2,40	2,40	19	2,40	0,35
8	-0,80	-3,30	20	2,40	2,20
9	-0,80	-1,50	21	2,40	4,00
10	-0,80	0,35	22	4,00	1,30
11	-0,80	2,20	23	4,00	-0,55
12	-0,80	4,00	24	4,00	-2,40

Miniatur Rundsteckverbinder Serie 423 Miniature circular connectors series 423

Kennlinien Ratings

Schirmdämpfungskurve nach DIN 47 250-6 für Kabelstecker, gerade Ausführung mit Schirmring, (Kabeltyp IEEE 802.3)

Attenuation curve according to DIN 47 250-6 for straight male cable connectors with shielding ring, (cable version IEEE 802.3)

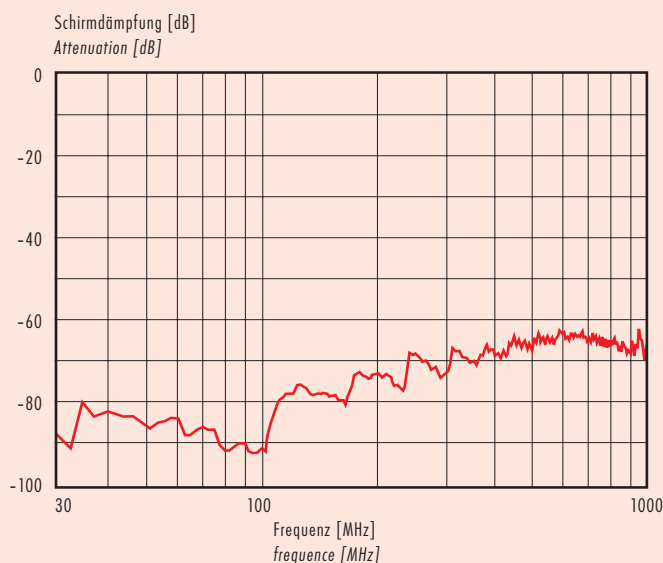

Schirmdämpfungskurve nach DIN 47 250-6 für Kabelstecker, gerade Ausführung mit Kabelklemme, (Kabeltyp IEEE 802.3)

Attenuation curve according to DIN 47 250-6 for straight female cable connector with cable clamp, (cable version IEEE 802.3)

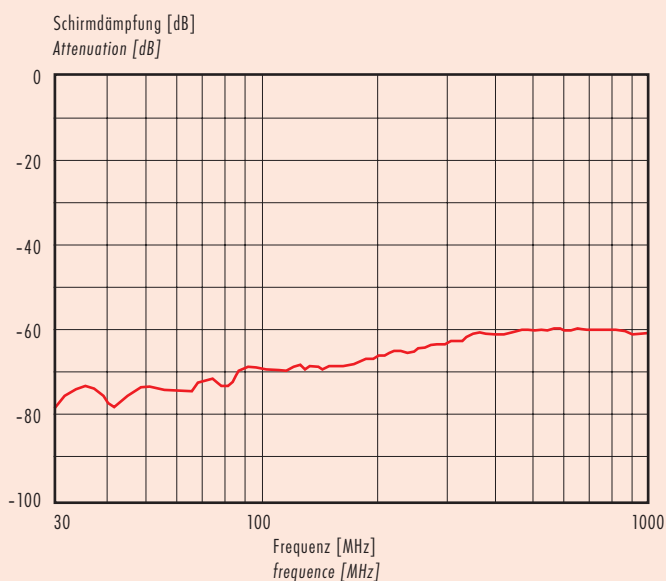

Schirmdämpfungskurve nach DIN 47 250 für Winkelsteckverbinder (Kabeltyp IEEE 802.3)

Attenuation curve according to DIN 47 250 for angled cable connectors (cable version IEEE 802.3)

