





120×120×38 mm

San Ace 120W 9WV type   

General Specifications

- Material Frame: Aluminum (Black coating), Impeller: Plastic (Flammability: UL 94V-1)
- Expected life See the table below. (L10 life: 90% survival rate for continuous operation in indoor free air at 60°C, rated voltage)
- Motor protection function Locked rotor burnout protection, Reverse polarity protection
For details, please refer to p. 547.
- Dielectric strength 50/60 Hz, 500 VAC, for 1 minute (between lead wire conductors and frame)
- Insulation resistance 10 MΩ or more with a 500 VDC megger (between lead wire conductors and frame)
- Sound pressure level (SPL) At 1 m away from the air inlet
- Storage temperature -30 to +70°C (Non-condensing)
- Lead wire ⊕Red ⊖Black (Sensor) Yellow (Control) Brown
- Mass 440 g
- Ingress protection IP68

Specifications

The models listed below **have pulse sensors with PWM control function.**

Model no.	Rated voltage [V]	Operating voltage range [V]	PWM duty cycle* [%]	Rated current [A]	Rated input [W]	Rated speed [min ⁻¹]	Max. airflow [m ³ /min] [CFM]	Max. static pressure [Pa] [inchH ₂ O]	SPL [dB (A)]	Operating temperature [°C]	Expected life [h]
9WV1212P1J001	12	10.2 to 13.8	100	3	36	6400	6.35 224.0	360 1.45	64	-20 to +70	60000/60°C
			0	0.2	2.4	1500	1.49 52.6	19.8 0.08	33		
9WV1224P1J601	24	20.4 to 27.6	100	1.5	36	6400	6.35 224.0	360 1.45	64		
			0	0.12	2.88	1500	1.49 52.6	26.1 0.105	33		
9WV1224P1H001**			100	0.8	19.2	5200	5.16 182	237 0.95	58		
9WV1248P1J001	48	40.8 to 55.2	100	0.65	31.2	6400	6.35 224.0	360 1.45	64		
			0	0.06	2.88	1500	1.49 52.6	26.1 0.105	33		

* PWM frequency: 25 kHz ** Fan does not rotate when PWM duty cycle is 0%.

The following sensor and control options are available for selection.

Available for all models. **Without sensor**

Differs according to the model. Refer to the table on p. 581. **Pulse sensor** **Lock sensor**

Airflow - Static Pressure Characteristics / PWM Duty - Speed Characteristics Example

9WV1212P1J001 With pulse sensor with PWM control function

PWM duty cycle

Operating voltage range

PWM duty - Speed characteristics example

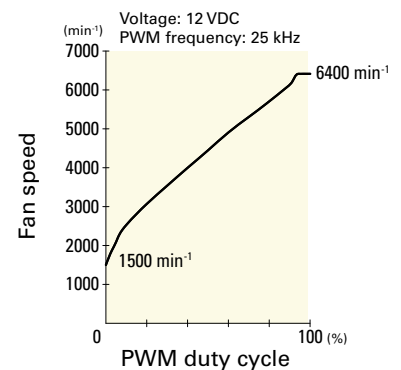
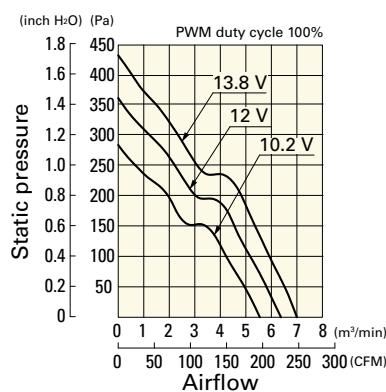
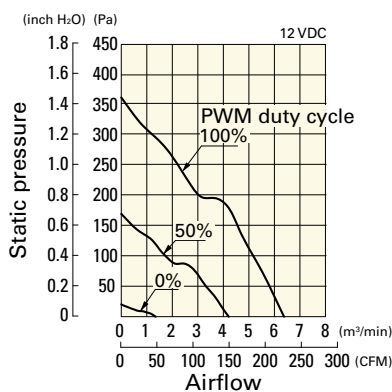

Airflow - Static Pressure Characteristics / PWM Duty - Speed Characteristics Example

9WV1224P1J601 With pulse sensor with PWM control function

PWM duty cycle

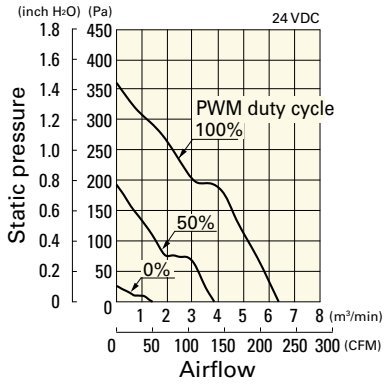

Operating voltage range

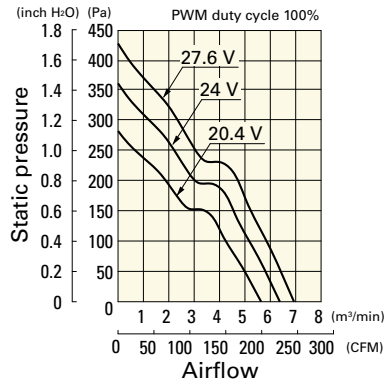

PWM duty - Speed characteristics example

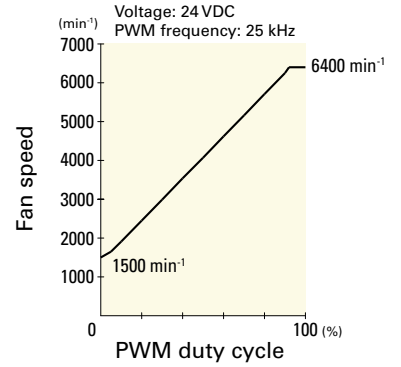

9WV1224P1H001 With pulse sensor with PWM control function

PWM duty cycle

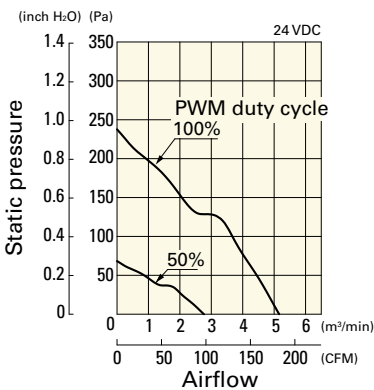

Operating voltage range

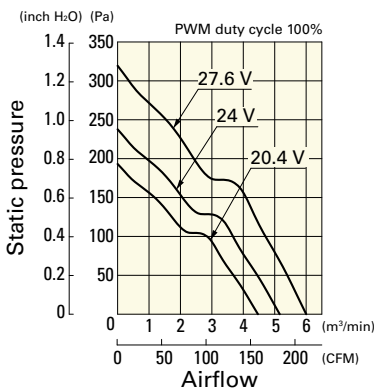

PWM duty - Speed characteristics example

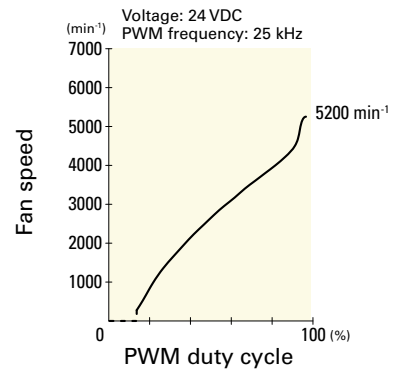

9WV1248P1J001 With pulse sensor with PWM control function

PWM duty cycle

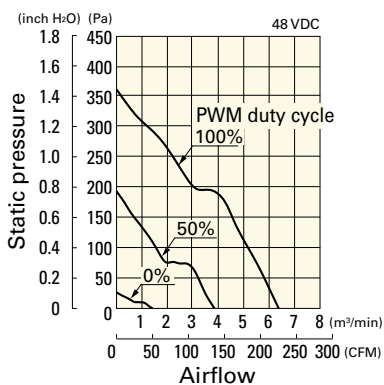

Operating voltage range

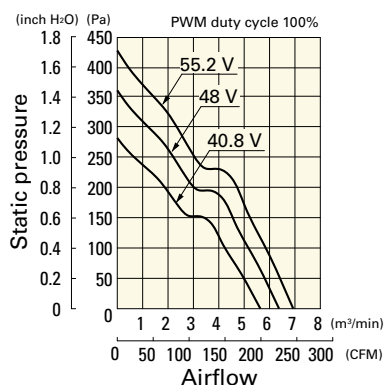

PWM duty - Speed characteristics example

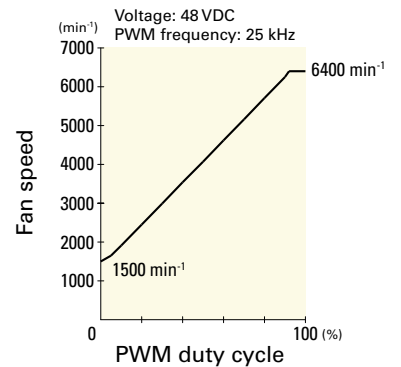

Dimensions (unit: mm)

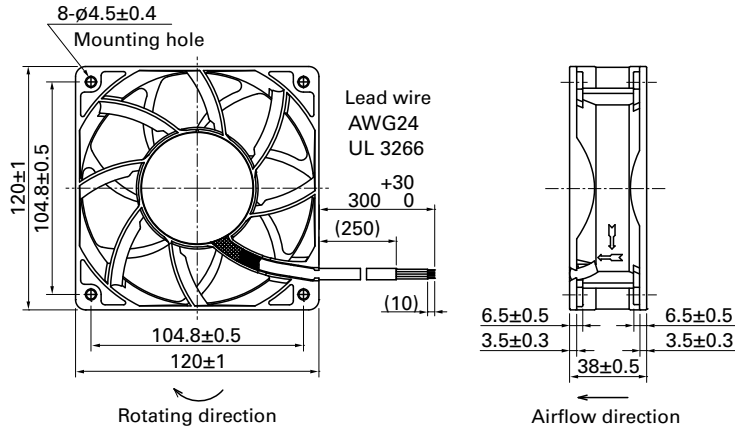

Reference Dimensions of Mounting Holes and Vent Opening (unit: mm)

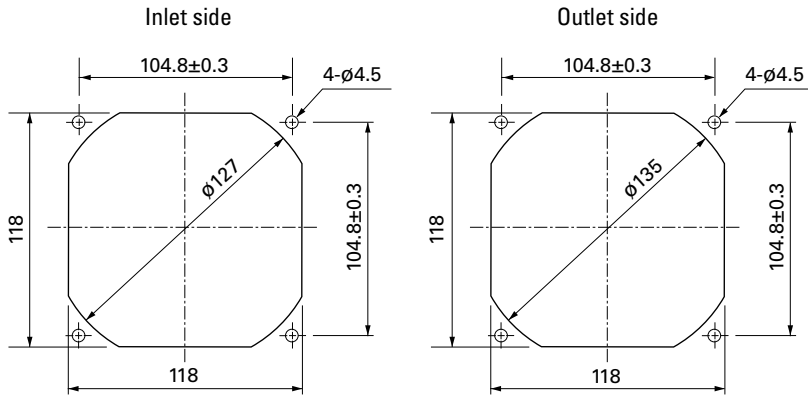

Options

Finger guards

page: p. 533

Model no.: 109-019E, 109-019K, 109-019C, 109-019H

Resin finger guards

page: p. 539

Model no.: 109-1000G