

SISO V-Pol Panel Antenna, 694MHz-4000MHz

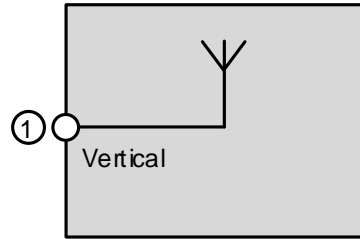

not binding



block diagram

| Part number                               |            | BN A77140            |         |           |           |           |
|---|------------|----------------------|---------|-----------|-----------|-----------|
| Connector                                 |            | 4.3-10 female (50 Ω) |         |           |           |           |
| Frequency range, [MHz]                    |            | 694-806              | 806-960 | 1350-1710 | 1710-2700 | 3400-4000 |
| Gain, [dBi]                               |            | 5.0±0.5              | 6.0±0.5 | 7.0±0.5   | 7.5±0.5   | 8.5±0.5   |
| Polarization                              |            | Vertical             |         |           |           |           |
| Beam width, [deg]                         | Horizontal | 80                   | 80      | 65        | 60        | 55        |
|   | Vertical   | 73                   | 70      | 60        | 60        | 30        |
| Front-To-Back Ratio, [dB]                 |            | ≥5                   | ≥8      | ≥10       | ≥12       | ≥10       |
| VSWR                                      |            | ≤2.0                 |         |           |           |           |
| Intermodulation (IM3)<br>@ 2x 20 W, [dBc] |            | ≤ -153               |         |           |           |           |
| Input power, [W]                          |            | max. 50              |         |           |           |           |
| Degree of protection                      |            | Indoor / IP54        |         |           |           |           |
| Weight, without Mounting Kit, [kg]        |            | 0.4                  |         |           |           |           |
| Radome Material and Color                 |            | ABS, White, RAL9003  |         |           |           |           |
| Temperature range, [°C]                   |            | -55 – +60            |         |           |           |           |
| Dimensions (H x W x D), [mm]              |            | 180 x 170 x 60       |         |           |           |           |
| Operational Humidity                      |            | <95%                 |         |           |           |           |
| RoHS                                      |            | Compliant            |         |           |           |           |
| Flammability rating                       |            | UL 94-V0             |         |           |           |           |
| Mounting Kit                              |            | On-wall              |         |           |           |           |

**Radiation pattern:**

**Horizontal pattern**

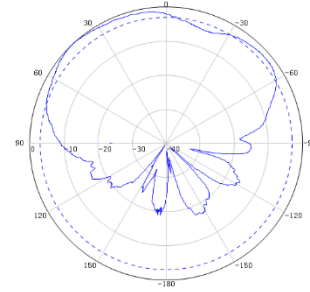
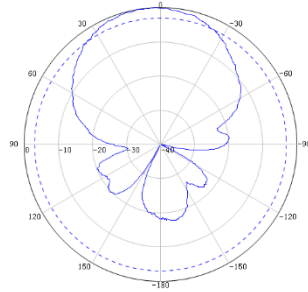
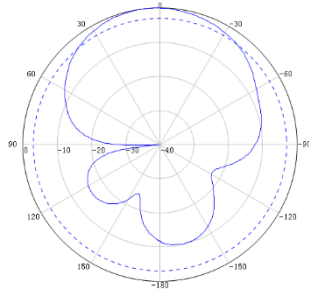

**Vertical pattern**

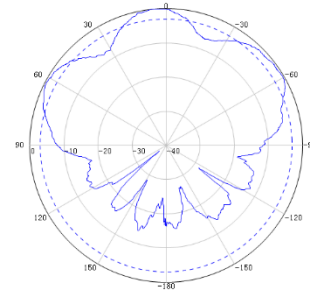
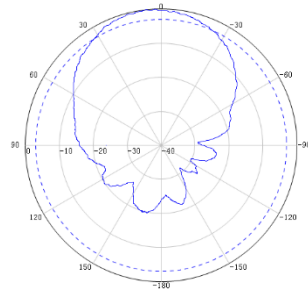
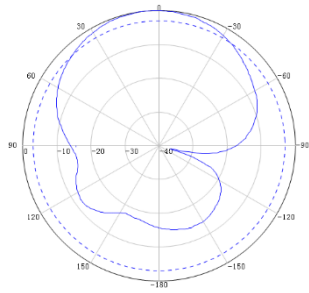

900MHz

1880MHz

3500MHz

**Dimensions and mounting:**

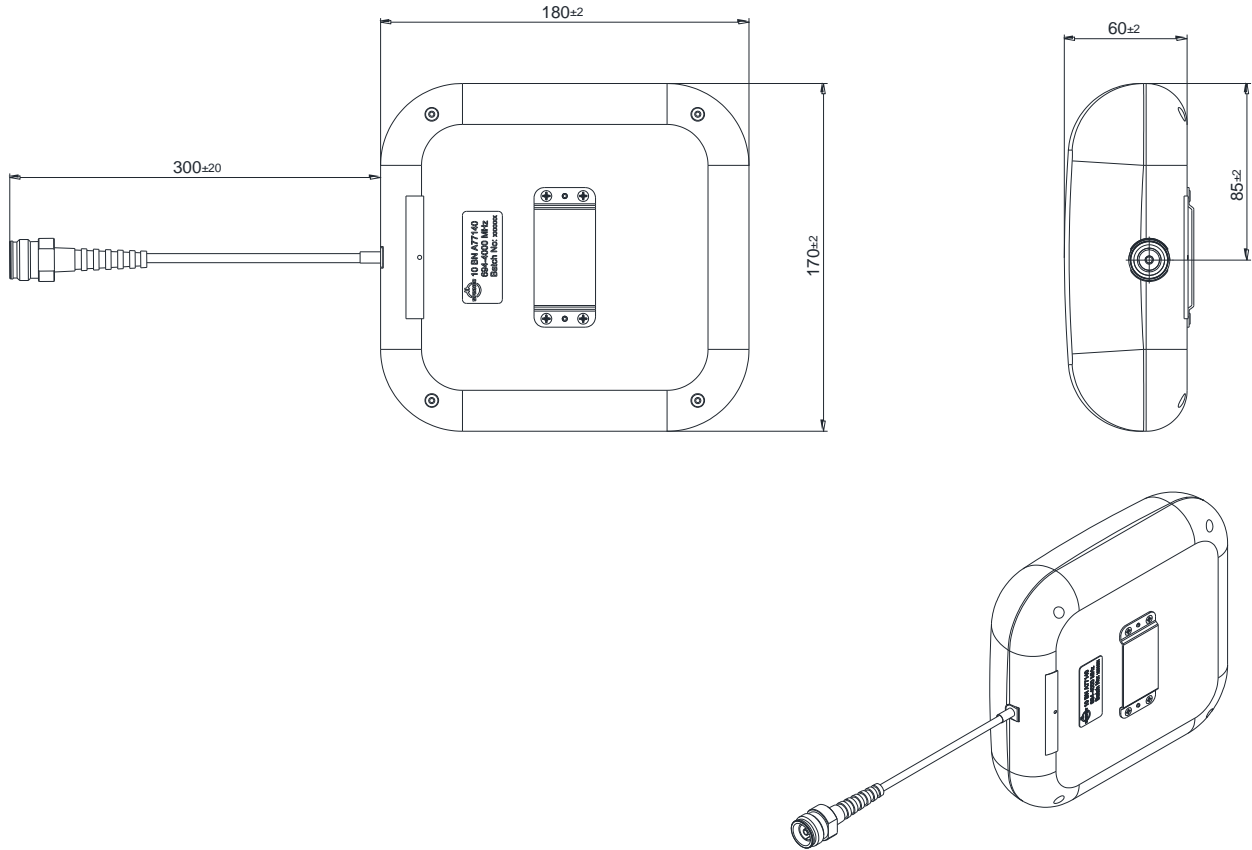

**Standard:**  
4.3-10 female (50 ohms): IEC 61169-54

Subject to change without notice

**Mounting kit:**

