

Surface Mount Band Stop Filter

BSF-C75+

50Ω 65 to 85 MHz

The Big Deal

- High rejection, 48 dB typical
- Stopband (65 to 85 MHz)
- Miniature shielded package



CASE STYLE: HU1186

Product Overview

The BSF-C75+ is stopband filter fabricated using SMT Technology. Covering 65 to 85 MHz stopband, this units offer good rejection. This unit uses a miniature high Q capacitors and wire welded inductors for high reliability. It has repeatable performance across production lots and consistent performance across temperature.

Key Features

Feature	Advantages
High rejection, 48 dB typical	BSF-C75+ enables the filter to attenuate spurious signals and reject harmonics for broadband of frequencies.
Shielded package	Shielded package (Size of .087" x 0.80" x 0.25") reduced interface with and from the surrounding components.
Application	Useful in broadcast systems and SATCOM transceiver

Notes

- A. Performance and quality attributes and conditions not expressly stated in this specification document are intended to be excluded and do not form a part of this specification document.
B. Electrical specifications and performance data contained in this specification document are based on Mini-Circuit's applicable established test performance criteria and measurement instructions.
C. The parts covered by this specification document are subject to Mini-Circuits standard limited warranty and terms and conditions (collectively, "Standard Terms"); Purchasers of this part are entitled to the rights and benefits contained therein. For a full statement of the Standard Terms and the exclusive rights and remedies thereunder, please visit Mini-Circuits' website at www.minicircuits.com/MCLStore/terms.jsp



Surface Mount Band Stop Filter

BSF-C75+

50Ω 65 to 85 MHz



CASE STYLE: HU1186

Features

- High rejection, 48 dB typical
- Aqueous washable
- Miniature shielded package

Applications

- FM radio
- Broadcast system
- SATCOM transceiver
- Lab use

Electrical Specifications at 25°C

Parameter	F#	Frequency (MHz)	Min.	Typ.	Max.	Unit	
Pass Band, Lower	Insertion Loss	DC-F1	DC -48	-	0.6	1.5	dB
	VSWR	DC-F1	DC - 48	-	1.3	1.7	:1
Stop Band	Rejection	F4-F5	65 - 85	30	48	-	dB
	VSWR	F4-F5	65 - 85	-	11	-	:1
Pass Band, Upper	Insertion Loss	F2-F3	115 - 1000	-	0.7	1.5	dB
	VSWR	F2-F3	115 - 1000	-	1.3	1.7	:1

Maximum Ratings

Operating Temperature	-40°C to 85°C
Storage Temperature	-55°C to 100°C
RF Power Input	250 mW max.

Permanent damage may occur if any of these limits are exceeded.

Functional Schematic

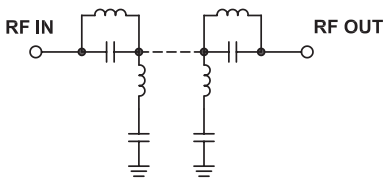

Typical Performance Data at 25°C

Frequency (MHz)	Insertion Loss (dB)	VSWR (:1)
1	0.02	1.01
25	0.14	1.20
48	0.54	1.28
56	4.45	3.16
58	13.16	9.38
60	24.68	15.67
62	39.60	19.98
65	55.90	25.19
75	65.61	35.46
85	54.91	30.49
89	40.91	24.48
93	21.00	15.67
95	13.94	10.31
98	5.95	3.92
100	3.03	2.04
105	1.16	1.10
110	0.81	1.16
115	0.62	1.08
500	0.21	1.03
1000	0.32	1.10

Typical Frequency Response

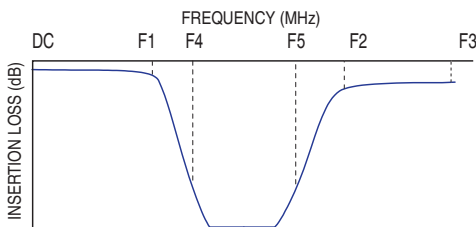

+RoHS Compliant

The +Suffix identifies RoHS Compliance. See our web site for RoHS Compliance methodologies and qualifications

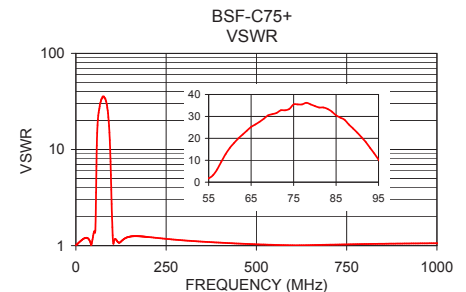
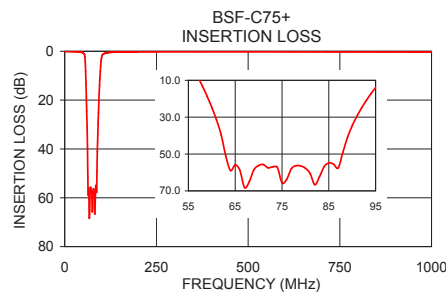

Notes

- Performance and quality attributes and conditions not expressly stated in this specification document are intended to be excluded and do not form a part of this specification document.
- Electrical specifications and performance data contained in this specification document are based on Mini-Circuit's applicable established test performance criteria and measurement instructions.
- The parts covered by this specification document are subject to Mini-Circuits standard limited warranty and terms and conditions (collectively, "Standard Terms"); Purchasers of this part are entitled to the rights and benefits contained therein. For a full statement of the Standard Terms and the exclusive rights and remedies thereunder, please visit Mini-Circuits' website at www.minicircuits.com/MCLStore/terms.jsp



www.minicircuits.com P.O. Box 350166, Brooklyn, NY 11235-0003 (718) 934-4500 sales@minicircuits.com

REV. A
M160153
BSF-C75+
EDU1284
URJ/NY
161230
Page 2 of 3

Pin Connections

INPUT	2
OUTPUT	13
NOT CONNECTED	6,9
GROUND	1,3,4,5,7,8,10,11,12,14

Demo Board MCL P/N: TB-378 Suggested PCB Layout (PL-347)

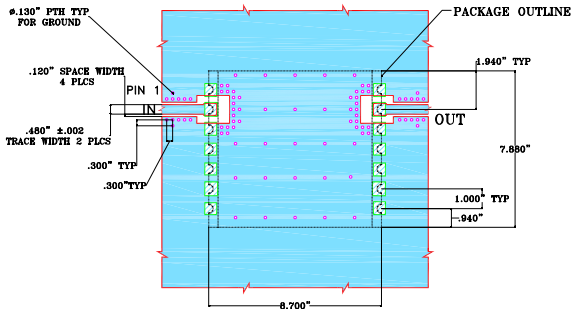

NOTES:

- TRACE WIDTH IS SHOWN FOR ROGERS R04350B WITH DIELECTRIC THICKNESS .030" ±.003". COPPER: 1/2 OZ. EACH SIDE. FOR OTHER MATERIALS TRACE WIDTH MAY NEED TO BE MODIFIED.
- BOTTOM SIDE OF THE PCB IS CONTINUOUS GROUND PLANE.

- DENOTES PCB COPPER LAYOUT WITH SMOBC (SOLDER MASK OVER BARE COPPER)
- DENOTES COPPER LAND PATTERN FREE OF SOLDERMASK

Outline Drawing

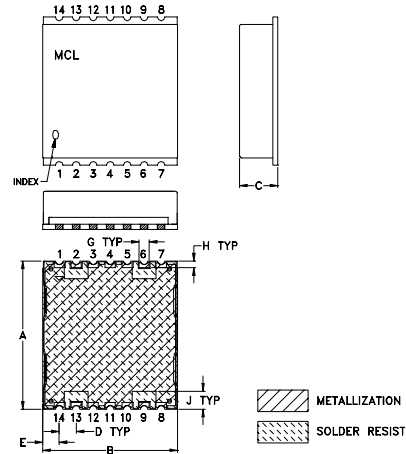

PCB Land Pattern

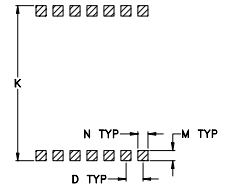

Suggested Layout,
Tolerance to be within ±.002

Outline Dimensions (inch)

A	B	C	D	E	F	G	H
.870	.800	.25	.100	.097	--	.060	.040
22.10	20.32	6.35	2.54	2.46	--	1.52	1.02
J	K	L	M	N	P	wt	
.105	.910	--	.060	.060	--	grams	
2.67	23.11	--	1.52	1.52	--	2.85	

Notes

- Performance and quality attributes and conditions not expressly stated in this specification document are intended to be excluded and do not form a part of this specification document.
- Electrical specifications and performance data contained in this specification document are based on Mini-Circuit's applicable established test performance criteria and measurement instructions.
- The parts covered by this specification document are subject to Mini-Circuits standard limited warranty and terms and conditions (collectively, "Standard Terms"); Purchasers of this part are entitled to the rights and benefits contained therein. For a full statement of the Standard Terms and the exclusive rights and remedies thereunder, please visit Mini-Circuits' website at www.minicircuits.com/MCLStore/terms.jsp