

Proximity Inductive Sensors Extended Range, Nickel-Plated Brass Housing Types ICB, M12

CARLO GAVAZZI



- Sensing distance: 4 to 8 mm
- Flush or non-flush types
- Short or long body versions
- Rated operational voltage (U_b): 10 - 36 VDC
- Output: DC 200 mA, NPN or PNP
- Normally open or Normally closed
- LED indication for output ON
- Protection: reverse polarity, short circuit, transients
- Cable or M12 plug versions
- According to IEC 60947-5-2
- Laser engraved on front cap, permanently legible
- CSA certified for Hazardous Locations



Product Description

A family of inductive proximity switches in industrial standard nickel-plated brass housings. They are able to handle applications where high sensing range is requested.

Output is open collector NPN or PNP transistors.

Ordering Key **ICB12S30F04NOM1**

Type	_____
Housing style	_____
Housing material	_____
Housing size	_____
Housing length	_____
Thread length	_____
Detection principle	_____
Sensing distance	_____
Output type	_____
Output configuration	_____
Connection	_____

Type Selection

Conne- ction	Body style	Rated operating distance S_n	Ordering no. NPN, Normally open	Ordering no. PNP, Normally open	Ordering no. NPN, Normally closed	Ordering no. PNP, Normally closed
Cable	Short	4 mm ¹⁾	ICB12S30F04NO	ICB12S30F04PO	ICB12S30F04NC	ICB12S30F04PC
Cable	Short	8 mm ²⁾	ICB12S30N08NO	ICB12S30N08PO	ICB12S30N08NC	ICB12S30N08PC
Plug	Short	4 mm ¹⁾	ICB12S30F04NOM1	ICB12S30F04POM1	ICB12S30F04NCM1	ICB12S30F04PCM1
Plug	Short	8 mm ²⁾	ICB12S30N08NOM1	ICB12S30N08POM1	ICB12S30N08NCM1	ICB12S30N08PCM1
Cable	Long	4 mm ¹⁾	ICB12L50F04NO	ICB12L50F04PO	ICB12L50F04NC	ICB12L50F04PC
Cable	Long	8 mm ²⁾	ICB12L50N08NO	ICB12L50N08PO	ICB12L50N08NC	ICB12L50N08PC
Plug	Long	4 mm ¹⁾	ICB12L50F04NOM1	ICB12L50F04POM1	ICB12L50F04NCM1	ICB12L50F04PCM1
Plug	Long	8 mm ²⁾	ICB12L50N08NOM1	ICB12L50N08POM1	ICB12L50N08NCM1	ICB12L50N08PCM1

¹⁾ For flush mounting in metal

²⁾ For non-flush mounting in metal

Specifications

Rated operational voltage (U_b)	10 to 36 VDC (ripple incl.)	Indication for short circuit/ overload	LED blinking (f = 2 Hz)
Ripple	≤ 10%	Assured operating sensing distance (S_a)	$0 \leq S_a \leq 0.81 \times S_n$
Output current (I_o)	≤ 200 mA @ 50°C (≤ 150 mA @ 50-70°C)	Effective operating distance (S_e)	$0.9 \times S_n \leq S_e \leq 1.1 \times S_n$
OFF-state current (I_i)	≤ 50 μA	Usable operating distance (S_u)	$0.9 \times S_r \leq S_u \leq 1.1 \times S_r$
No load supply current (I_o)	≤ 15 mA	Repeat accuracy (R)	≤ 10%
Voltage drop (U_d)	Max. 2.5 VDC @ 200 mA	Differential travel (H) (Hysteresis)	1 to 20% of sensing dist.
Protection	Reverse polarity, short-circuit, transients	Ambient temperature	Operating -25° to +70°C (-13° to +158°F) Storage -30° to +80°C (-22° to +176°F)
Voltage transient	1 kV/0.5 J	Shock and vibration	IEC 60947-5-2/7.4
Power ON delay (t_o)	≤ 20 ms		
Operating frequency (f)	≤ 2000 Hz		
Indication for output ON	Activated LED, yellow		
NO version	Target present		
NC version	Target not present		

Specifications (cont.)

Housing material	
Body	Nickel-plated brass
Front	Grey thermoplastic polyester
Connection	
Cable	Ø4.1 x 2 m, 3 x 0.25 mm ² , grey PVC, oil proof
Plug	M12 x 1
Degree of protection	IP 67
Weight (cable/nuts included)	
Cable	Max. 120 g
Plug	Max. 30 g
Dimensions	See diagrams below
Tightening torque	10 Nm
Approvals	cULus (UL508)
	cCSAus As Process Control Equipment for Hazardous Locations.
	- Class I, Division 2, Groups A, B, C and D.
	- T5, Enclosure Type 4.
	Ambient temperature Ta: -25° to +60°C

Note: The terminal connector (version ...M1) was not evaluated. The suitability of the terminal connector should be determined in the end-use application.

Approvals (cont.)	CCC is not required for products with a maximum operating voltage of ≤ 36 V
EMC protection	According to IEC 60947-5-2
IEC 61000-4-2 (ESD)	8 KV air discharge, 4 KV contact discharge
IEC 61000-4-3	3 V/m
IEC 61000-4-4	2 kV
IEC 61000-4-6	3 V
IEC 61000-4-8	30 A/m
MTTF_d	750 years @ 50°C (122°F)

Dimensions (mm)

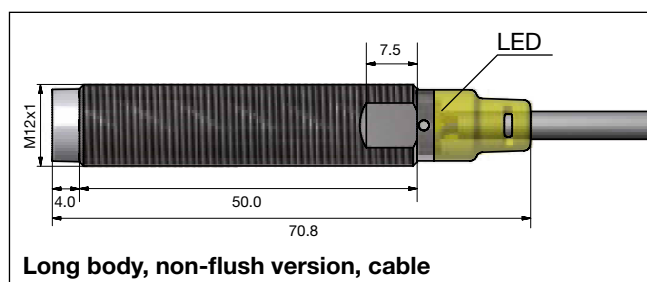
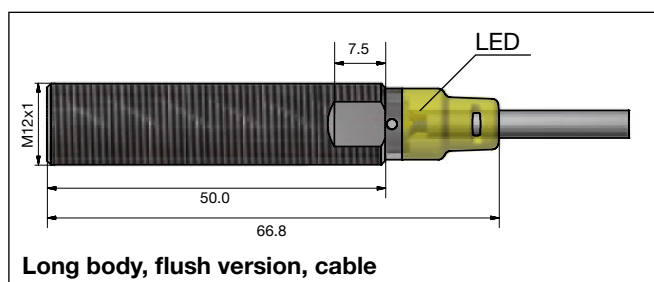
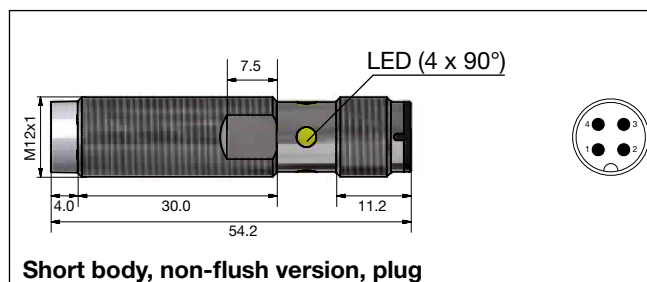
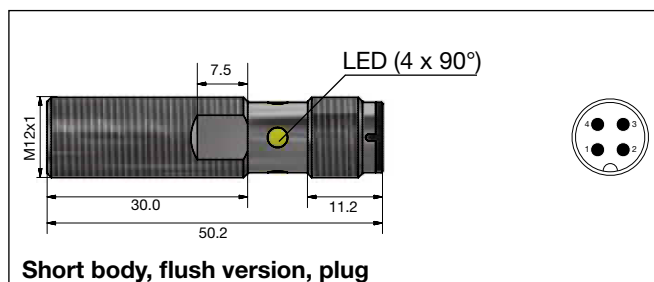
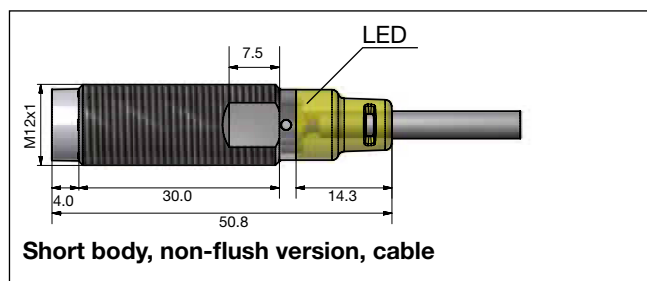
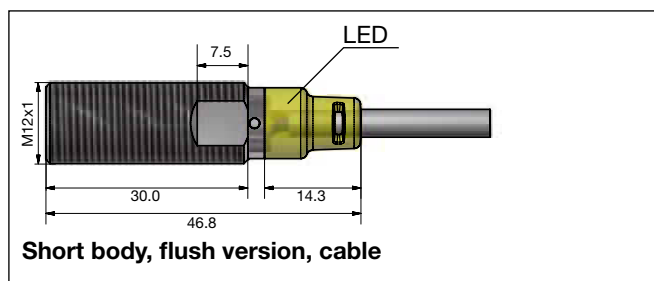

Dimensions (mm) (cont.)

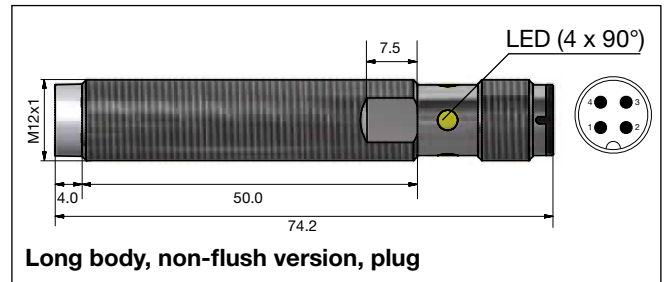
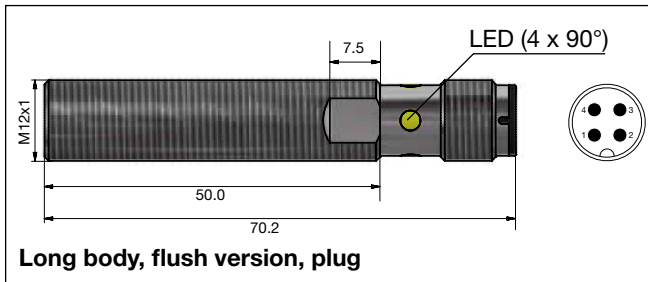

Installation

Flush sensor, when installed in damping material, must be according to Picture 1A.

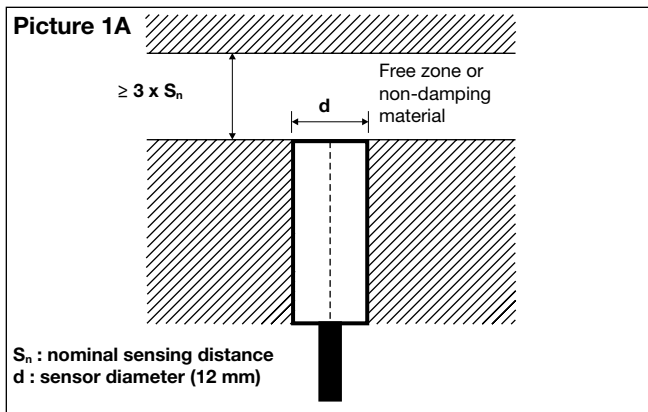

Non-flush sensor, when installed in damping material, must be according to Picture 1B.

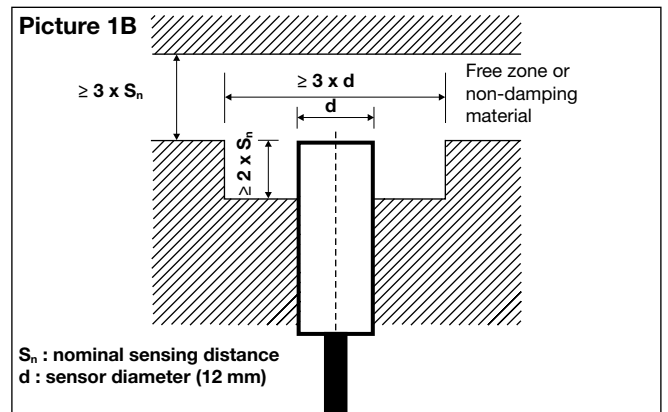

Flush sensors, when installed together in damping material, must be according to Picture 2A.

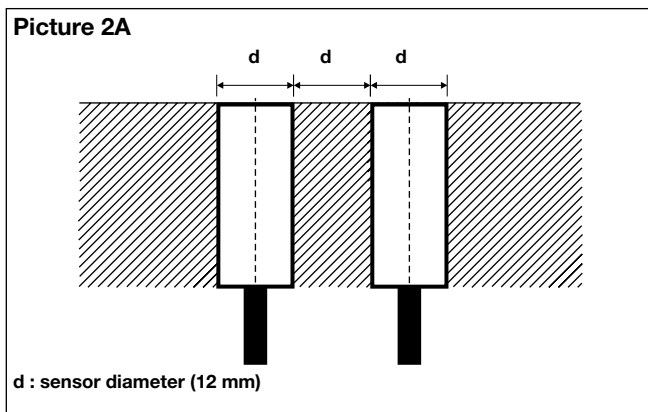

Non-flush sensors, when installed together in damping material, must be according to Picture 2B.

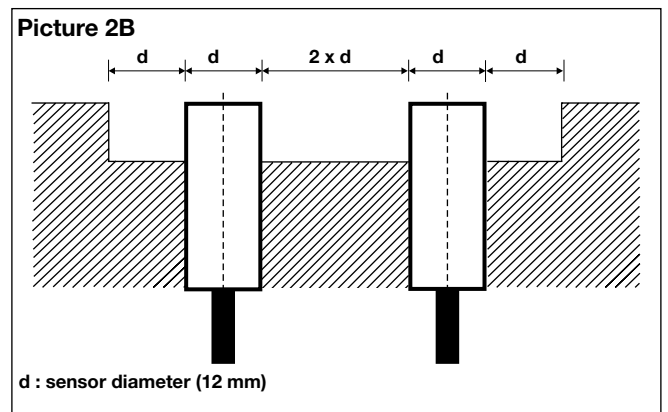

For sensors installed opposite each other, a minimum space of $6 \times S_n$ (the nominal sensing distance) must be observed (See Picture 3).

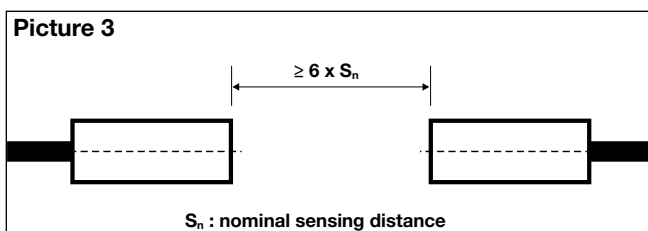



Wiring Diagram

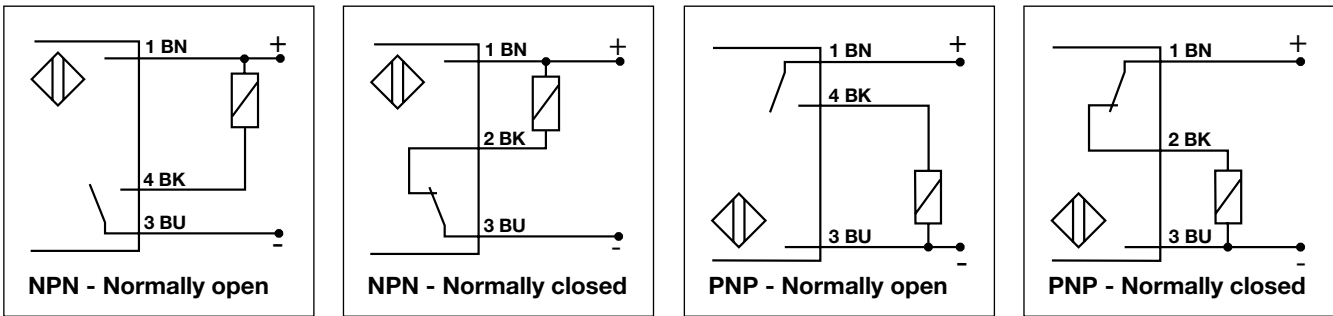

Reduction Factors

The rated operating distance is reduced by the use of metals and alloys other than Fe360.

The most important reduction factors for inductive proximity sensors are shown in Picture 4.

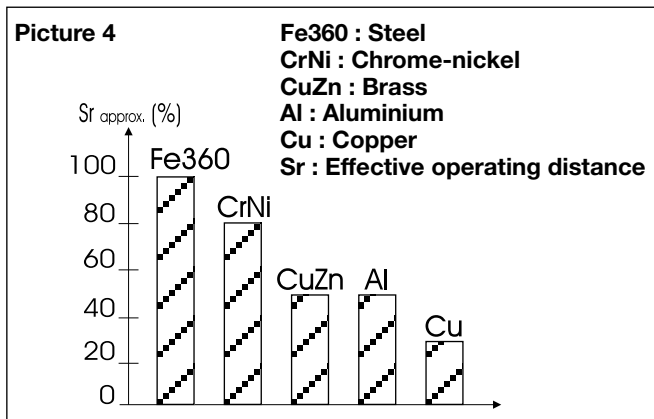

Delivery Contents

- Inductive proximity switch ICB.
- 2 nuts NPB
- Packaging: plastic bag

Accessories for Plug Versions

	PVC	PUR
3-wire angled connector, 2 m cable	CONB13NF-A2	CONB13NF-A2P
3-wire angled connector, 5 m cable	CONB13NF-A5	CONB13NF-A5P
3-wire angled connector, 10 m cable	CONB13NF-A10	CONB13NF-A10P
3-wire angled connector, 15 m cable	CONB13NF-A15	CONB13NF-A15P
3-wire straight connector, 2 m cable	CONB13NF-S2	CONB13NF-S2P
3-wire straight connector, 5 m cable	CONB13NF-S5	CONB13NF-S5P
3-wire straight connector, 10 m cable	CONB13NF-S10	CONB13NF-S10P
3-wire straight connector, 15 m cable	CONB13NF-S15	CONB13NF-S15P

For any additional information or different options, please refer to the "General Accessories - Connector Cables -Type CONB1..." datasheets.