

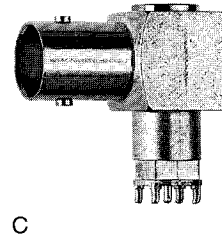

2 BNC

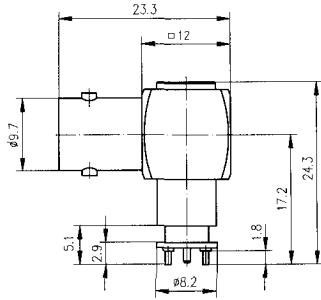
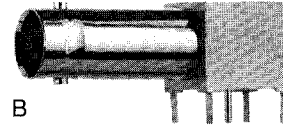
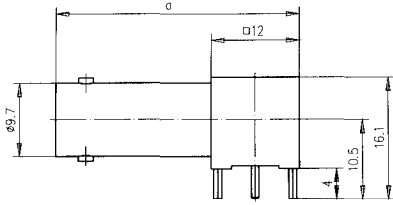

Bestell-Nr. Order Nr.	Z	Montage Assembly	Abb. Fig.	Anmerkungen Remarks
J01001A1948	50	Z06	A	a = 23
J01001A0064	50	Z06	A	a = 30
J01001A0049	50	Z25	C	
J01003A0018	75	Z06	A	a = 30
J01003A1949	75	Z06	A	a = 23
J01003A0030	75	Z06	B	a = 33.3
J01003A0026	75	Z25	C	

20. BNC-Kupplung
BNC Adaptor

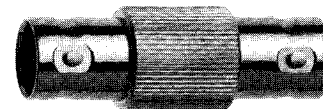
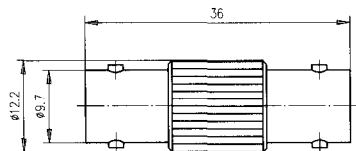
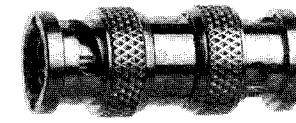
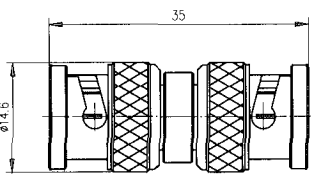

Bestell-Nr. Order Nr.	MIL-Std. MIL-Std.	Z	Abb. Fig.	Anmerkungen Remarks
J01004A0806	UG-491A/U	50	A	Sti-Sti/m-m
J01004A0618	UG-914/U	50	B	Bu-Bu/f-f
J01005A1230		75	A	Sti-Sti/m-m
J01005A1229		75	B	Bu-Bu/f-f