

Ceramic

Low Pass Filter

LFCN-900+

50Ω DC⁽¹⁾ to 850 MHz

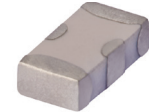

Generic photo used for illustration purposes only
CASE STYLE: FV1206

Maximum Ratings

| | |
|-----------------------|------------------|
| Operating Temperature | -55°C to 100°C |
| Storage Temperature | -55°C to 100°C |
| RF Power Input* | 10W max. at 25°C |

* Passband rating, derate linearly to 3.5-W at 100°C ambient. Permanent damage may occur if any of these limits are exceeded.

Pin Connections

| | |
|--------|-----|
| RF IN | 1 |
| RF OUT | 3 |
| GROUND | 2,4 |

Outline Drawing

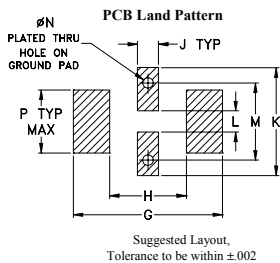
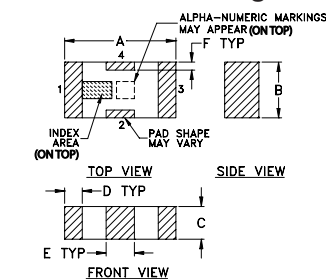

Outline Dimensions (inch/mm)

| A | B | C | D | E | F | G | |
|------|------|------|------|------|------|------|-------|
| .126 | .063 | .037 | .020 | .032 | .009 | .169 | |
| 3.20 | 1.60 | 0.94 | 0.51 | 0.81 | 0.23 | 4.29 | |
| H | J | K | L | M | N | P | wt |
| .087 | .024 | .122 | .024 | .087 | .012 | .071 | grams |
| 2.21 | 0.61 | 3.10 | 0.61 | 2.21 | 0.30 | 1.80 | .020 |

Demo Board MCL P/N: TB-270 Suggested PCB Layout (PL-137)

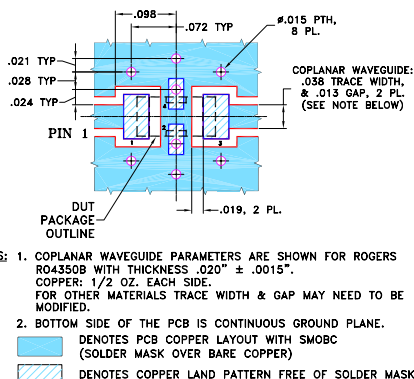

- NOTES:
1. COPLANAR WAVEGUIDE PARAMETERS ARE SHOWN FOR ROGERS RO4350B WITH THICKNESS .020" ± .0015". COPPER: 1/2 OZ. EACH SIDE. FOR OTHER MATERIALS TRACE WIDTH & GAP MAY NEED TO BE MODIFIED.
 2. BOTTOM SIDE OF THE PCB IS CONTINUOUS GROUND PLANE.
 - DENOTES PCB COPPER LAYOUT WITH SMOBC (SOLDER MASK OVER BARE COPPER)
 - DENOTES COPPER LAND PATTERN FREE OF SOLDER MASK

Features

- excellent power handling, 10W
- small size
- 7 sections
- temperature stable
- LTCC construction
- rejection in stopband, 45-50 dB typ.
- protected by U.S. Patent 6,943,646

Applications

- harmonic rejection
- VHF/UHF transmitters/receivers
- lab use

Electrical Specifications^(1,2) at 25°C

| Parameter | F# | Frequency (MHz) | Min. | Typ. | Max. | Unit | |
|-----------|----------------|-----------------|-----------|------|------|------|----|
| Pass Band | Insertion Loss | DC-F1 | DC-850 | — | — | 1.3 | dB |
| | Freq. Cut-Off | F2 | 1075 | — | 3.0 | — | dB |
| | VSWR | DC-F1 | DC-850 | — | 1.2 | — | :1 |
| Stop Band | Rejection Loss | F3 | 1275 | 20 | — | — | dB |
| | | F4-F5 | 1350-4850 | — | 30 | — | dB |
| | VSWR | F6 | 5100 | — | 20 | — | dB |
| | | F3-F6 | 1275-5100 | — | 20 | — | :1 |

- (1) In Applications where DC isolation to ground is required, coupling capacitors are recommended to avoid DC leakage. Alternatively, if DC pass IN-OUT is required, Mini-Circuits "D" suffix version of this model will support DC IN-OUT, and provide >100 MOhm isolation to ground.
(2) Measured on Mini-Circuits Characterization Test Board TB-270.

Typical Frequency Response

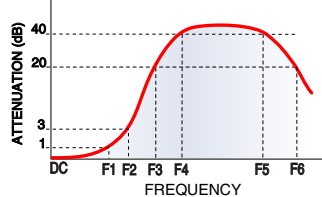

Electrical Schematic

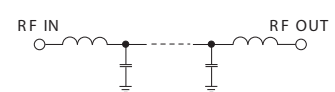

Typical Performance Data at 25°C

| Frequency (MHz) | Insertion Loss (dB) | VSWR (:1) |
|-----------------|---------------------|-----------|
| 50.00 | 0.10 | 1.05 |
| 500.00 | 0.38 | 1.14 |
| 840.00 | 0.81 | 1.14 |
| 1075.00 | 3.36 | 1.88 |
| 1275.00 | 28.73 | 18.50 |
| 1300.00 | 29.98 | 20.22 |
| 1350.00 | 31.63 | 23.18 |
| 2600.00 | 51.39 | 52.65 |
| 2860.00 | 48.32 | 51.10 |
| 4840.00 | 28.59 | 32.79 |
| 5000.00 | 26.32 | 30.49 |
| 5200.00 | 21.44 | 25.94 |
| 6500.00 | 21.81 | 20.22 |
| 7000.00 | 20.93 | 21.73 |
| 8000.00 | 20.09 | 22.29 |

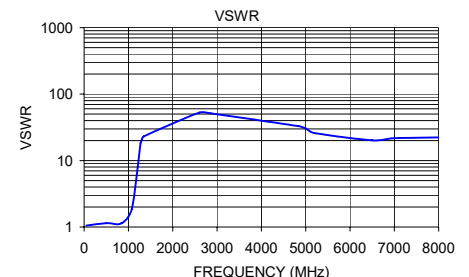

Notes

- A. Performance and quality attributes and conditions not expressly stated in this specification document are intended to be excluded and do not form a part of this specification document.
B. Electrical specifications and performance data contained in this specification document are based on Mini-Circuit's applicable established test performance criteria and measurement instructions.
C. The parts covered by this specification document are subject to Mini-Circuits standard limited warranty and terms and conditions (collectively, "Standard Terms"); Purchasers of this part are entitled to the rights and benefits contained therein. For a full statement of the Standard Terms and the exclusive rights and remedies thereunder, please visit Mini-Circuits' website at www.minicircuits.com/MCLStore/terms.jsp

