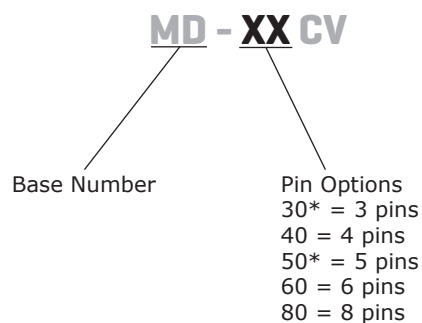

**SERIES:** MD-CV | **DESCRIPTION:** MINI DIN CONNECTOR**FEATURES**

- panel mount
- locking nut
- plastic bushing

**PART NUMBER KEY**

Notes: \*Discontinued models MD-30CV &amp; MD-50CV

**SPECIFICATIONS**

parameter	conditions/description	min	typ	max	units
rated input voltage			12		Vdc
rated input current	at 12 Vdc			2	A
contact resistance				30	mΩ
insulation resistance	at 250 Vdc	50			MΩ
voltage withstand	for 1 minute			250	Vac
insertion force				45	N
withdrawal force		9		30	N
operating temperature		-20		85	°C
life			1,000		cycles
flammability rating	UL94V-0				
RoHS	yes				

## MECHANICAL DRAWINGS

units: mm[inches]

tolerance:

X.X ±0.2 mm

X.XX ±0.10 mm

X.XXX ±0.050 mm

X.XXXX ±0.030 mm

	MATERIAL	PLATING
earth terminal	brass	nickel
terminal contacts (1~8)	phosphor bronze	tin
housing	PBT (UL94V-0)	black
nut	PBT (UL94V-0)	black

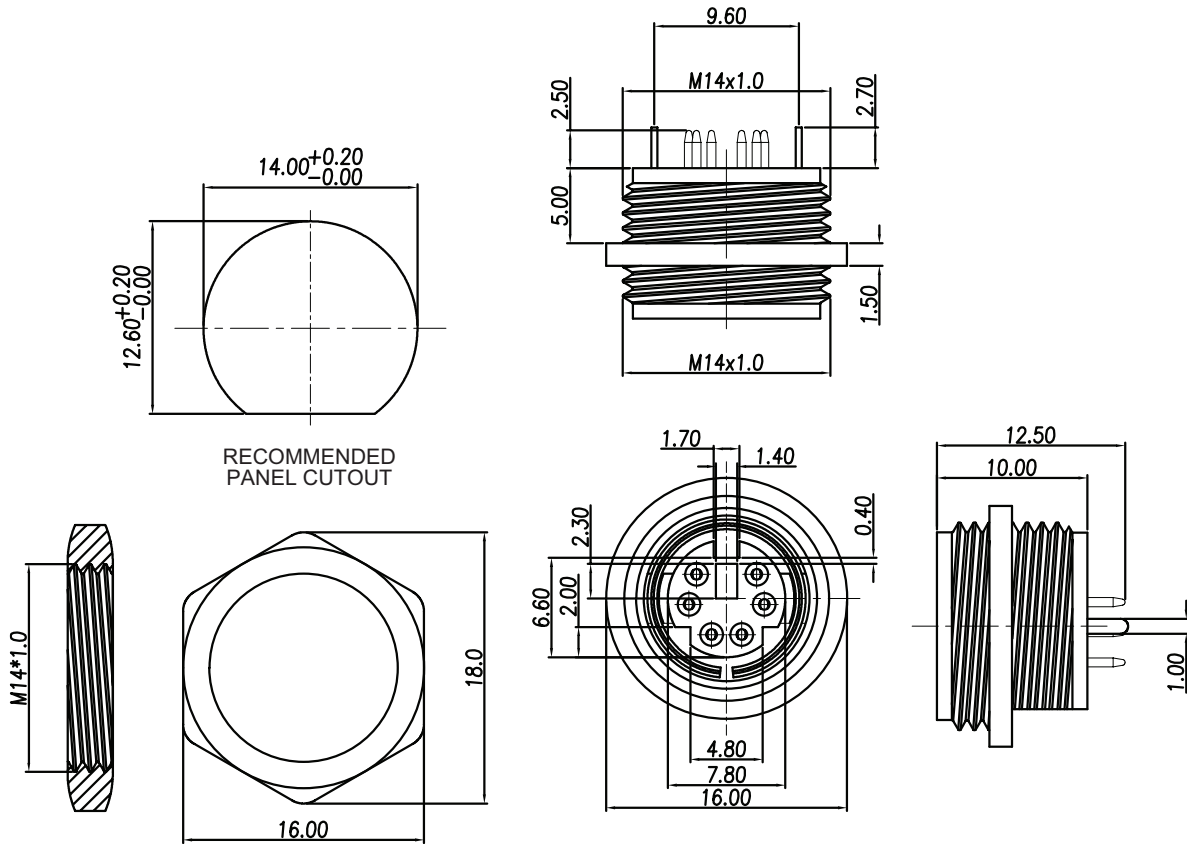

### MD-30CV

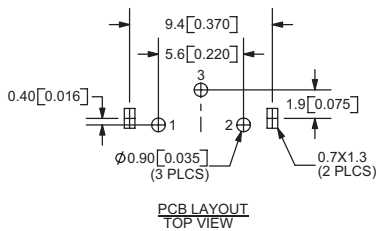
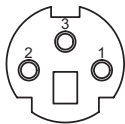

### MD-40CV

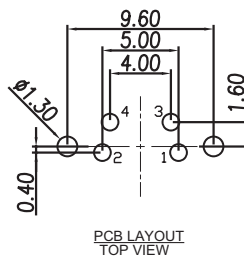
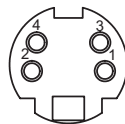

### MD-50CV

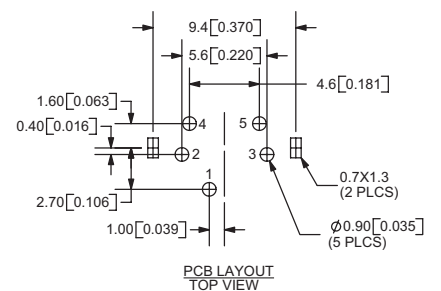
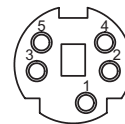

## MECHANICAL DRAWINGS (CONTINUED)

### MD-60CV

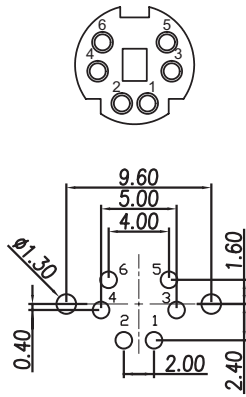

PCB LAYOUT  
TOP VIEW

### MD-80CV

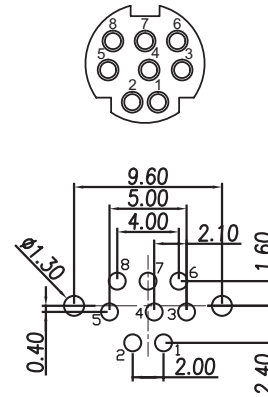

PCB LAYOUT  
TOP VIEW

## REVISION HISTORY

---

rev.	description	date
1.0	initial release	02/23/2006
1.01	new template applied	02/20/2012
1.02	updated datasheet	09/01/2017
1.03	discontinued models MD-30CV and MD-50CV, brand update	10/08/2019
1.04	updated housing	11/19/2019
1.05	updated PCB footprints	09/01/2020

The revision history provided is for informational purposes only and is believed to be accurate.

---

# CUI DEVICES

CUI Devices offers a one (1) year limited warranty. Complete warranty information is listed on our website.

CUI Devices reserves the right to make changes to the product at any time without notice. Information provided by CUI Devices is believed to be accurate and reliable. However, no responsibility is assumed by CUI Devices for its use, nor for any infringements of patents or other rights of third parties which may result from its use.

CUI Devices products are not authorized or warranted for use as critical components in equipment that requires an extremely high level of reliability. A critical component is any component of a life support device or system whose failure to perform can be reasonably expected to cause the failure of the life support device or system, or to affect its safety or effectiveness.