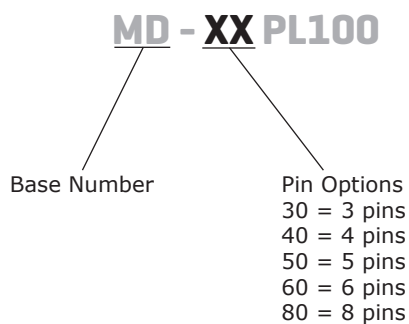

**SERIES:** MD-PL100 | **DESCRIPTION:** MINI DIN CONNECTOR**FEATURES**

- panel mount
- 10 cm lead wires
- 3~8 pins

**PART NUMBER KEY****SPECIFICATIONS**

parameter	conditions/description	min	typ	max	units
rated input voltage			30		Vdc
rated input current				1	A
contact resistance				30	mΩ
insulation resistance	at 250 Vdc	1,000			MΩ
voltage withstand	for 1 minute			500	Vac
insertion force				45	N
withdrawal force		9			N
operating temperature		-25		85	°C
life			500		cycles
flammability rating	UL94V-0				
RoHS	yes				

## MECHANICAL DRAWINGS

units: mm  
 tolerance:  
 X. ±0.2 mm  
 X.X ±0.10 mm  
 X.XX ±0.050 mm  
 X.XXX ±0.005 mm

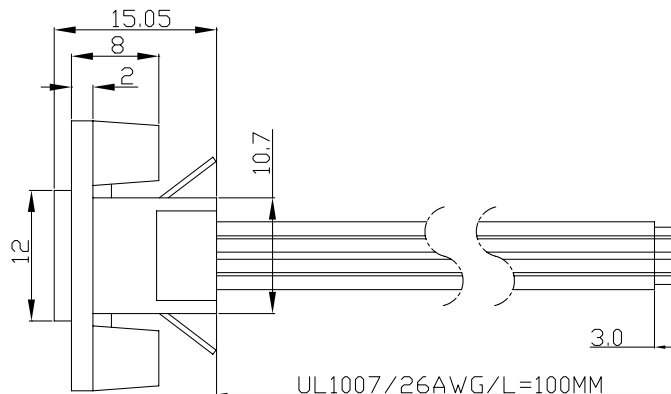
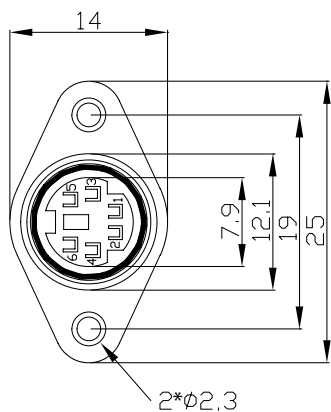
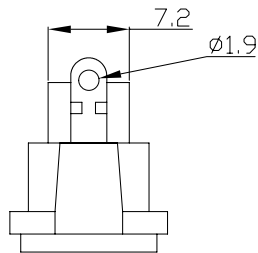

	MATERIAL	PLATING
body	PBT (UL94V-0)	
earth terminal	phosphor bronze	nickel
contact terminals	phosphor bronze	tin
wire	UL 1007/AWG #26	

**MD-30PL100**

**MD-40PL100**

**MD-50PL100**

**MD-60PL100**

**MD-80PL100**

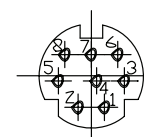
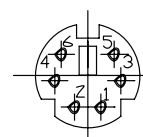
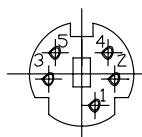
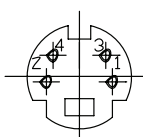
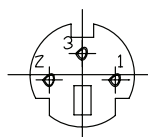

PIN	Wire Color	Wire Color	Wire Color	Wire Color	Wire Color
1	black	black	brown	brown	brown
2	green	green	black	white	white
3	orange	yellow	green	black	black
4		red	yellow	green	blue
5			red	yellow	green
6				red	yellow
7					orange
8					red

## REVISION HISTORY

---

rev.	description	date
1.0	initial release	02/23/2006
1.01	new template applied	03/07/2012
1.02	updated datasheet	08/25/2017
1.03	updated housing, brand update	10/14/2019

The revision history provided is for informational purposes only and is believed to be accurate.

---

# CUI DEVICES

CUI Devices offers a one (1) year limited warranty. Complete warranty information is listed on our website.

CUI Devices reserves the right to make changes to the product at any time without notice. Information provided by CUI Devices is believed to be accurate and reliable. However, no responsibility is assumed by CUI Devices for its use, nor for any infringements of patents or other rights of third parties which may result from its use.

CUI Devices products are not authorized or warranted for use as critical components in equipment that requires an extremely high level of reliability. A critical component is any component of a life support device or system whose failure to perform can be reasonably expected to cause the failure of the life support device or system, or to affect its safety or effectiveness.