

USB & Ethernet Controlled

RF SPDT Switch Matrix

RC-8SPDT-A18

50Ω DC to 18 GHz

The Big Deal

- Eight independent mechanical SPDT switches
- 20W power rating (cold switching)
- High isolation, 85 dB typ
- High reliability



Applications

- Fail safe / redundancy switching
- Automated test equipment
- Satcom switching

RoHS Compliant

See our web site for RoHS Compliance methodologies and qualifications

Product Overview

Mini-Circuits' RC 8SPDT A18 contains eight independently controlled, electro mechanical SPDT switches. Each switch operates over an extremely wide bandwidth, from DC to 18 GHz with high isolation and low insertion loss. The absorptive switches are of a failsafe and break before make configuration, with a lifetime of 5 million switching cycles per switch when used within the noted specifications.

The switch box is constructed in a compact, rugged metal case (4.5 x 12.0 x 2.25") with all SMA (f) RF connectors on the front panel. The switches are controlled via USB or Ethernet, allowing control directly from a PC, or remotely over a network. Full software support is provided, including our user friendly GUI application for Windows and a full API with programming instructions for Windows and Linux environments (both 32 bit and 64 bit systems). Download the software from our website at <https://www.minicircuits.com/softwaredownload/rfswitchcontroller.html>.

Key Features

Feature	Advantages
Eight mechanical SPDT switches	Mechanical absorptive switches provide high reliability, repeatable high performance and internal termination of input signals on the disconnected paths
High power operation from DC to 18 GHz	Supports a wide range of RF test and signal routing applications up to X and Ku bands, with 40W input power.
Break-before make configuration	Prevents a momentary connection of the old and new signal paths, reducing the inconsistent transient effects that could otherwise be observed during switching
USB & Ethernet control	USB HID and Ethernet (HTTP / Telnet) interfaces provide easy compatibility with a wide range of software setups and programming environments
Full software support	User friendly Windows GUI (graphical user interface) allows manual control straight out of the box, while the comprehensive API (application programming interface) with examples and instructions allows easy automation in most programming environments

Electrical Specifications

Parameter	Conditions	Min.	Typ.	Max.	Units
Frequency	—	DC		18	GHz
RF Insertion Loss (per switch)	DC to 1 GHz	—	0.10	0.15	dB
	1 GHz to 8 GHz	—	0.15	0.30	
	8 GHz to 12 GHz	—	0.25	0.40	
	12 GHz to 18 GHz	—	0.30	0.50	
RF VSWR	DC to 1 GHz	—	1.05	—	:1
	1 GHz to 8 GHz	—	1.20	—	
	8 GHz to 12 GHz	—	1.20	—	
	12 GHz to 18 GHz	—	1.25	—	
RF Isolation (per switch)	DC to 1 GHz	85	100	—	dB
	1 GHz to 8 GHz	75	90	—	
	8 GHz to 12 GHz	70	80	—	
	12 GHz to 18 GHz	60	66	—	
Switching Time	—	—	15	—	ms
RF Power (cold switching) ¹	—	—	—	40	W
Rated Voltage	24V _{DC} input USB port	23	24	25	V
Rated Current (24V _{DC} input)	All switches in COM -> 2 position	—	790	1055	mA
	All switches in COM -> 1 position	—	115	165	
Rated Current (USB port)		—	10	20	
Life (per switch)	@ 100 mW (hot switching) ²	—	5	—	million switching cycles
	@ 1 W (hot switching)	—	1	—	

¹. Maximum power for any connected through path as stated; maximum power into any internal termination is 1W

². Hot switching powers above this level will degrade the switch lifetime

Absolute Maximum Ratings⁴

Operating Temperature	0°C to 40°C
Storage Temperature	-15°C to 85°C
DC Voltage max.	26V

⁴ Permanent damage may occur if any of these limits are exceeded.

Connections

24V _{DC} IN	(2.1 mm center positive DC Socket)
RF Switch A (1, COM, 2)	(SMA female)
RF Switch B (1, COM, 2)	(SMA female)
RF Switch C (1, COM, 2)	(SMA female)
RF Switch D (1, COM, 2)	(SMA female)
RF Switch E (1, COM, 2)	(SMA female)
RF Switch F (1, COM, 2)	(SMA female)
RF Switch G (1, COM, 2)	(SMA female)
RF Switch H (1, COM, 2)	(SMA female)
USB	(USB type B receptacle)
Network (Ethernet/LAN)	(RJ45 socket)

Switching Configuration (Per Switch):

- Fail-Safe
- Absorptive (Internal terminations on ports J1-J2)

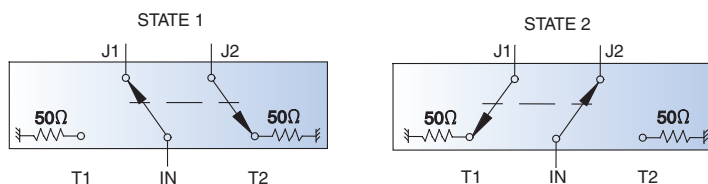

Insertion Loss

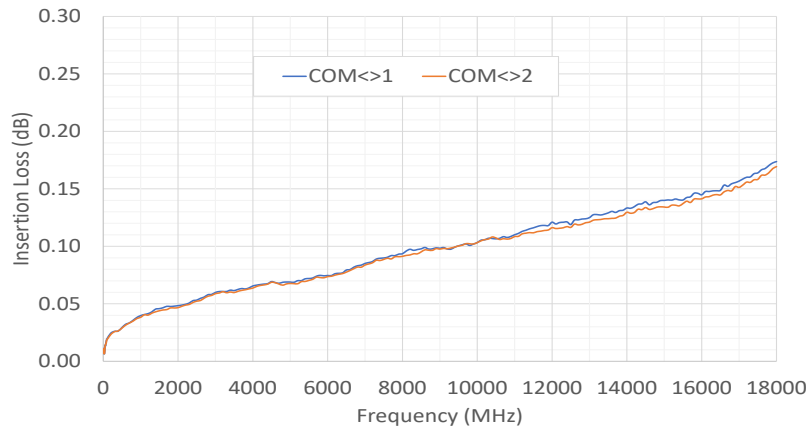

Isolation

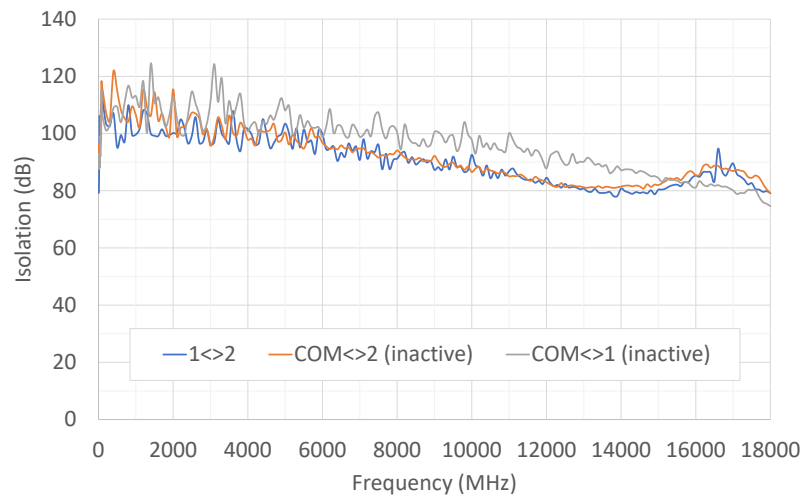

VSWR

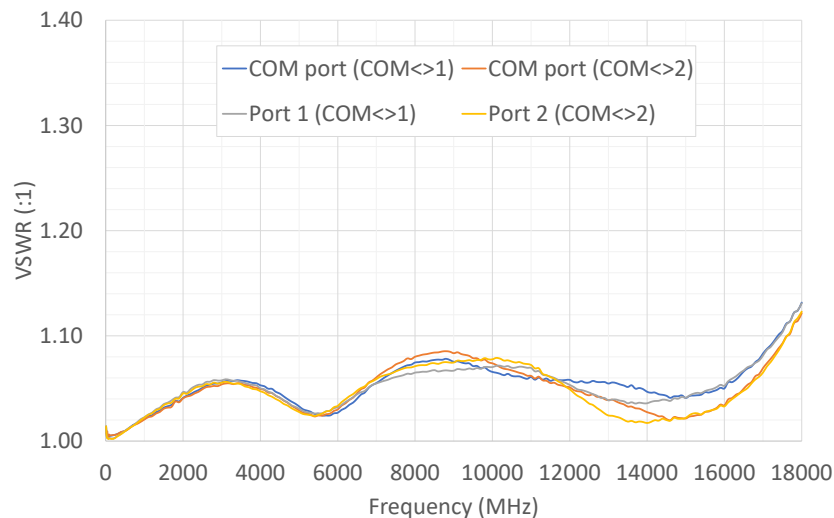

Outline Drawing (LM1852)

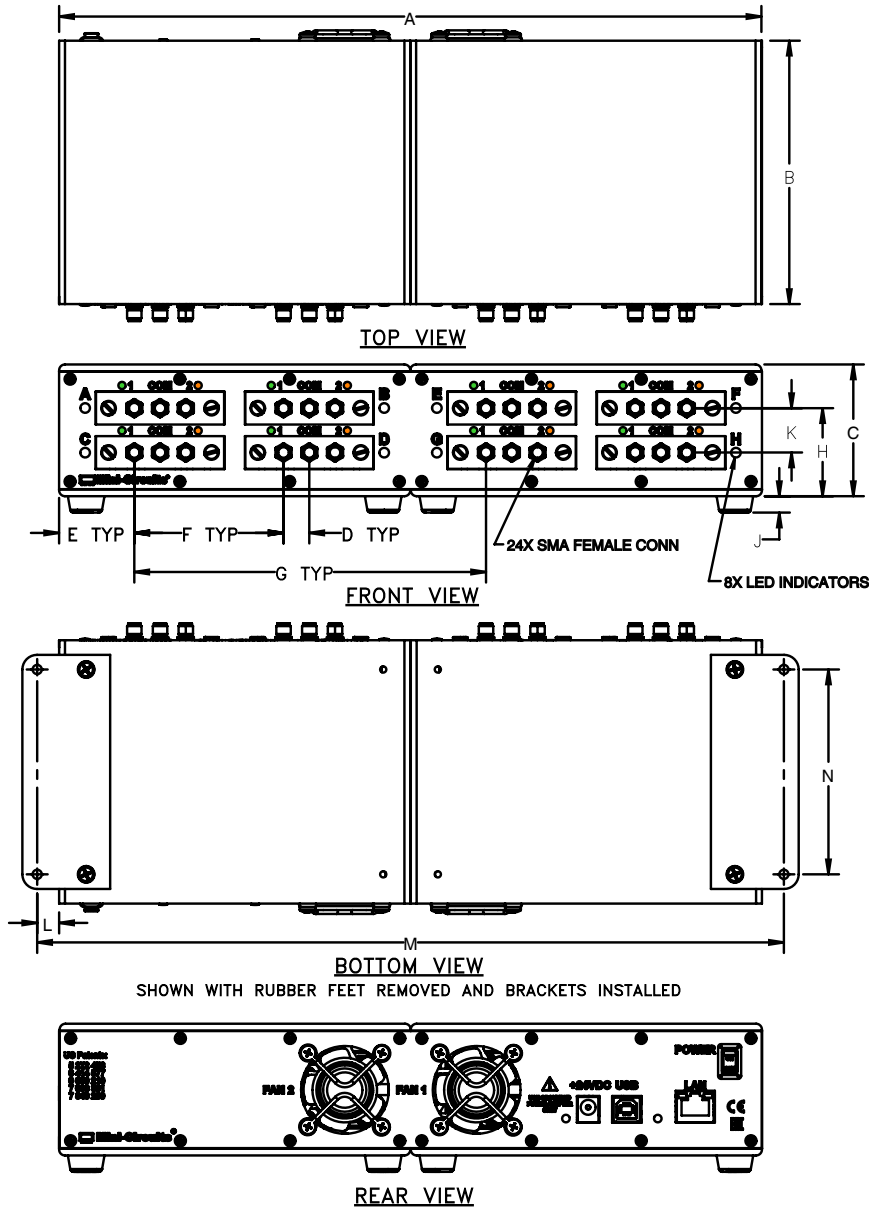

BRACKET OPTION ONE SET OF 2 EACH

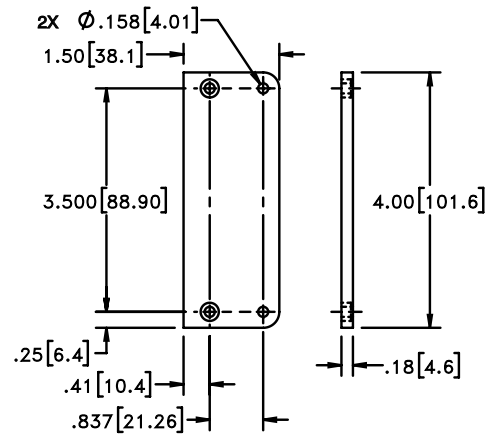

TOLERANCE: $\pm .005$

- INSTRUCTIONS FOR MOUNTING BRACKETS:
 TOOL REQUIRED: PHILLIPS HEAD SCREWDRIVER
 STEP 1: REMOVE RUBBER FEET FROM THE BOTTOM OF THE UNIT, DO NOT DISCARD THE FASTENERS.
 STEP 2: MOUNT THE BRACKETS WITH THE FASTENERS REMOVED IN STEP 1, USING THE COUNTER BORE HOLES IN THE BRACKET.

Outline Dimensions (inch / mm)

A	B	C	D	E	F	G	H	J	K	L	M	M	WT. GRAMS
12.00	4.50	2.25	.44	1.28	2.55	6.01	1.50	.28	.757	.375	12.75	3.500	2240
304.8	114.3	57.2	11.18	32.4	64.8	152.65	38.20	7.1	19.23	9.53	323.85	88.90	

Typical Switching Performance

The graphs below present the typical mechanical switching characteristic from the point of applying the internal DC voltage to the switch actuator (identified by the purple “trigger” trace). USB / Ethernet communication delays are excluded (in the order of several ms , depending on PC / network performance). The break before make process is visible in the sequence of events (the active switch path is disconnected, prior to connecting the final switch path).

Switching from COM<>1 to COM<>2 state: 6.95 ms

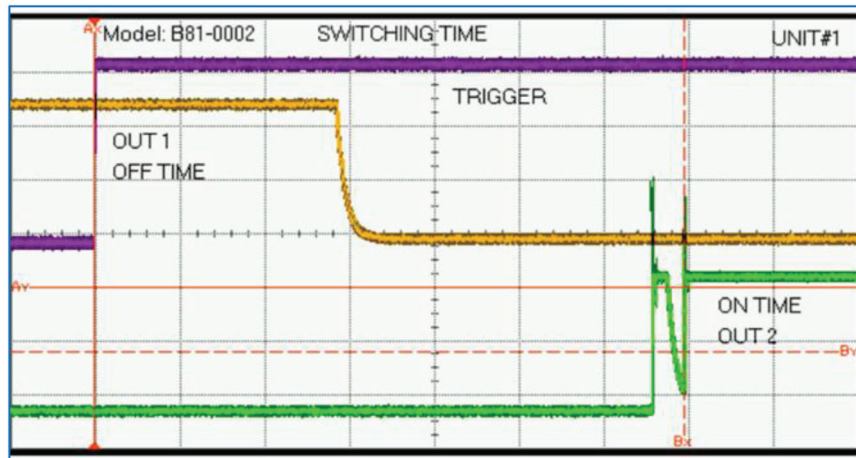

- █ Trigger
- █ COM <> 1 path (off time)
- █ COM <> 2 path (on time)

Horizontal scale: 1 ms per division

Switching from COM<>2 to COM<>1 state: 4.88 ms



- █ Trigger
- █ COM <> 1 path (on time)
- █ COM <> 2 path (off time)

Horizontal scale: 1 ms per division

Software Specifications

Software & Documentation Download:

- Mini-Circuits' full software and support package including user guide, Windows GUI, DLL files, programming manual and examples can be downloaded free of charge from <https://www.minicircuits.com/softwaredownload/rfswitchcontroller.html>
- Please contact testsolutions@minicircuits.com for support

Minimum System Requirements:

Parameter	Requirements	
Interface	USB HID & Ethernet (HTTP & Telnet)	
System Requirements	GUI	Windows 98 or later
	USB API DLL	Windows 98 or later and programming environment with ActiveX or .NET support
	USB Direct Programming	Linux, Windows 98 or later
	Ethernet	Windows, Linux or Mac computer with a network port and Ethernet TCP/IP support
Hardware	Pentium II or later with 256 MB RAM	

Application Programming Interface (API)

Ethernet Support:

- Simple ASCII / SCPI command set for attenuator control
- Communication via HTTP or Telnet
- Supported by most common programming environments

USB Support (Windows):

- ActiveX COM DLL file for creation of 32-bit programs
- .NET library DLL file for creation of 32 / 64-bit programs
- Supported by most common programming environments (refer to application note AN-49-001 for summary of supported environments)

USB Support (Linux):

- Direct USB programming using a series of USB interrupt codes

Full programming instructions and examples available for a wide range of programming environments / languages.

Graphical User Interface (GUI) for Windows - Key Features

- Connect via USB or Ethernet
- Run GUI in “demo mode” to evaluate software without a hardware connection

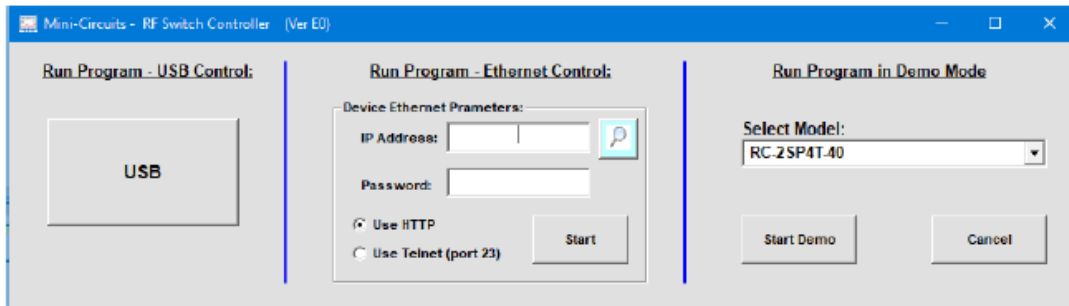



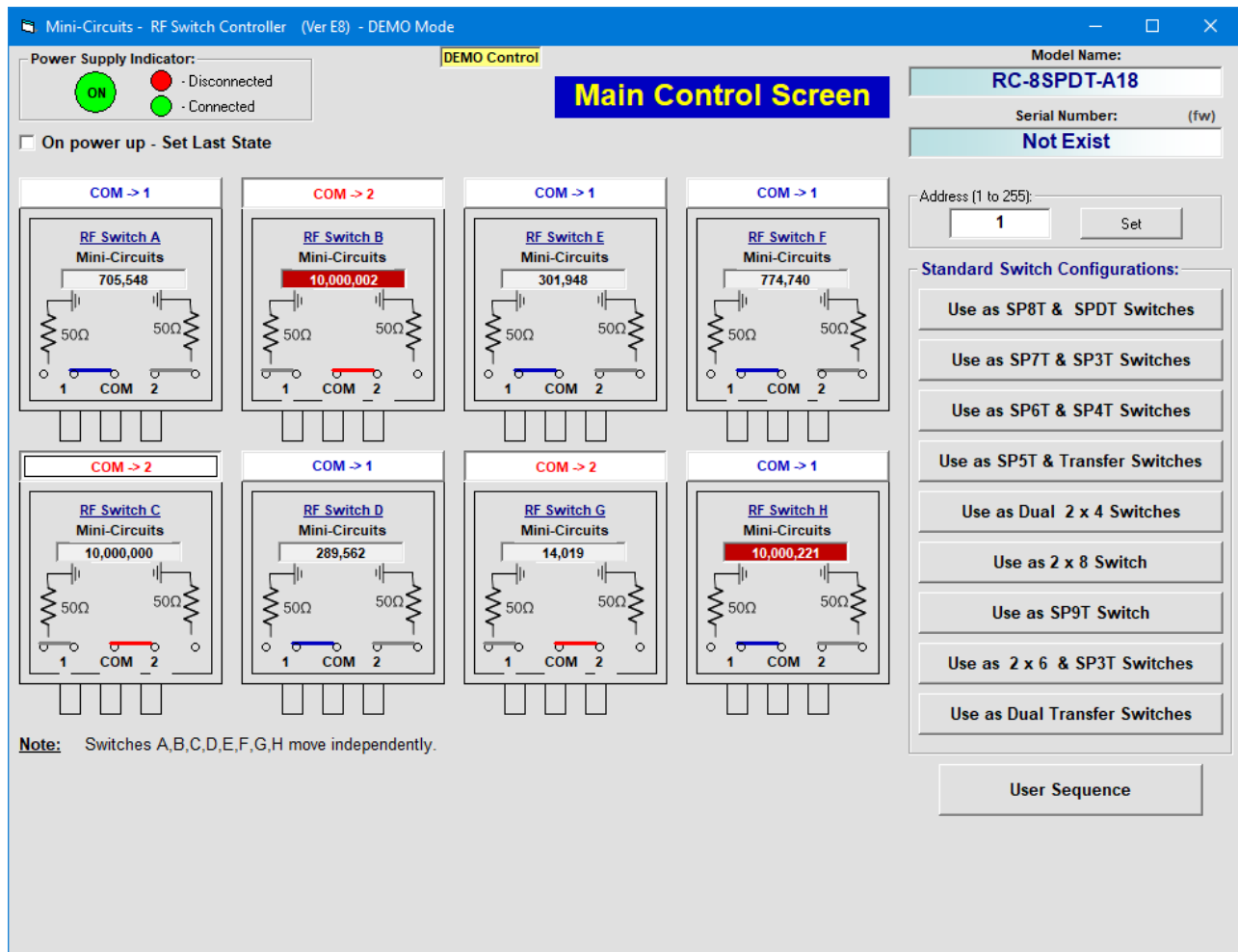





- View and set switch states at the click of a button
- Configure and run timed switching sequences
- Set start-up switch state
- Configure Ethernet IP Settings



Ordering, Pricing & Availability Information see our web site

Model	Description
RC-8SPDT-A18	USB/Ethernet RF SPDT Switch Matrix

Included Accessories	Part No.	Description
	AC/DC-24-3W1	AC/DC 24V _{DC} Grounded Power Adaptor. Operating temperature: 0°C to +40°C, I _{Max} =2.5A
	CBL-3W1-XX	AC Power Cord (Select one power cord from below with each Switch Matrix box)
	USB-CBL-AB-3+	2.7 ft (0.8 m) USB Cable: USB type A(Male) to USB type B(Male)

AC Power Cords ⁵	Part No.	Description
	CBL-3W1-US	Power Cord for United States
	CBL-3W1-EU	Power Cord for Europe
	CBL-3W1-UK	Power Cord for United Kingdom
	CBL-3W1-AU	Power Cord for Australia and China
	CBL-3W1-IL	Power Cord for Israel

⁵ Power cords for other countries are also available, if you need a power cord for a country not listed in the table please contact testsolutions@minicircuits.com.

Optional Accessories	Description
USB-CBL-AB-3+	2.7 ft (0.8 m) USB Cable: USB type A(Male) to USB type B(Male)
USB-CBL-AB-7+	6.8 ft (2.1 m) USB Cable: USB type A(Male) to USB type B(Male)
USB-CBL-AB-11+	11 ft (3.4 m) USB Cable: USB type A(Male) to USB type B(Male)
CBL-RJ45-MM-5+	5 ft (1.5 m) Ethernet cable: RJ45(Male) to RJ45(Male) Cat 5E cable
BKT-272-08+	Bracket (One set of 2 each)

Additional Notes

- A. Performance and quality attributes and conditions not expressly stated in this specification document are intended to be excluded and do not form a part of this specification document.
- B. Electrical specifications and performance data contained in this specification document are based on Mini-Circuit's applicable established test performance criteria and measurement instructions.
- C. The parts covered by this specification document are subject to Mini-Circuits standard limited warranty and terms and conditions (collectively, "Standard Terms"); Purchasers of this part are entitled to the rights and benefits contained therein. For a full statement of the Standard Terms and the exclusive rights and remedies thereunder, please visit Mini-Circuits' website at www.minicircuits.com/MCLStore/terms.jsp