



THE BIG DEAL

- Eight independently programmable channels
- Over 100 dB Isolation between channels
- Repeatable 0-95 dB attenuation range
- SSH Secure Ethernet communication
- Power over Ethernet (PoE) per IEEE 802.3af

APPLICATIONS

- Wi-Fi 6E MIMO development
- LTE / 5G / IoT / Bluetooth / Zigbee
- Cellular handover testing
- C-band radar / satcom testing
- Automated signal sweeping / fading



Generic photo used for illustration purposes only

PRODUCT OVERVIEW

Mini-Circuits' RC8DAT-8G-95 is an 8-channel programmable attenuator capable of supporting a wide range of signal level control applications from 1 MHz to 8 GHz. All 8 channels can be independently controlled with 0.25 dB attenuation resolution and more than 100 dB isolation between the channels. The dynamic range of each channel is 0 to 95 dB for applications up to 7.2 GHz and 0 to 90 dB up to 8 GHz. The unique attenuation design maintains linear attenuation change per dB, even at the highest attenuation settings.

All 4 bi-directional RF channels are housed in a single, compact and rugged package (3.00" x 5.17" x 1.16") with SMA female connectors on all RF ports. Ethernet (RJ45) with PoE and USB (type C) ports are both included to provide flexible control and DC supply options.

Full software support is provided, including our user-friendly GUI application for Windows and a full API with programming instructions for Windows and Linux environments (both 32-bit and 64-bit systems).

KEY FEATURES

Feature	Advantages
Programmable attenuation sequences	Configure timed sweep and hop sequences to run unaided without additional user interaction.
Wide attenuation range	Independently controllable 0-95 dB attenuators on each channel allow simulation of a wide range of test scenarios including receiver sensitivity, device / base-station handovers, device failures, and interference effects.
Safe attenuation transitions	Carefully synchronized attenuation transitions are implemented to prevent momentary reductions in attenuation whilst changing states, which would otherwise cause spikes in power level at the output.
Power over Ethernet (PoE)	Control and power the attenuator via a PoE network to simplify connections and allow remote attenuator operation over long Ethernet cable runs. Compliant with IEEE 802.3af mode A and mode B.
Secure Ethernet communication	Support for SSH (Secure Shell protocol) provides a means for secure communication over Ethernet networks with strict security policies. HTTP & Telnet communication via Ethernet are also supported.

Trademarks:

All trademarks cited within this document are the property of their respective owners. Neither Mini-Circuits nor the Mini-Circuits products are affiliated with or endorsed or sponsored by the owners of the referenced trademarks. Mini-Circuits and the Mini-Circuits logo are registered trademarks of Scientific Components Corporation.



ELECTRICAL SPECIFICATIONS¹, +25°C

Parameter	Conditions	Frequency (MHz)	Min.	Typ.	Max.	Unit
Attenuation Range	0.25 dB step	1 - 7200	0	-	95	dB
		7200 - 8000	0	-	90	
Attenuation Accuracy ²	0.25 - 20 dB	1 - 2000	-0.7	0.4	0.4+5.0% of setting	dB
		2000 - 4000	-0.7	1.0	0.4+5.0% of setting	
		4000 - 6000	-0.4-5.0% of setting	-0.2	0.75+4.0% of setting	
		6000 - 7200	-0.4-5.0% of setting	-0.5	0.7	
		7200 - 8000	-0.6-6.0% of setting	-0.6	0.3	
	20.25 - 60 dB	1 - 2000	-0.4-0.5% of setting	1.7	0.9+4.5% of setting	
		2000 - 4000	-0.7	1.0	0.8+4.5% of setting	
		4000 - 6000	-0.5-4.5% of setting	-0.6	1.2+2.0% of setting	
		6000 - 7200	-0.7-4.5% of setting	-1.8	0.7	
		7200 - 8000	-1.2-4.5% of setting	-2.1	0.3	
	60.25 - 80 dB	1 - 2000	-0.4-0.5% of setting	3.0	-0.4+6.0% of setting	
		2000 - 4000	-0.6-1.0% of setting	2.0	-0.8+6.5% of setting	
		4000 - 6000	-0.2-5.0% of setting	-1.7	2.0+0.5% of setting	
		6000 - 7200	0.2-6.0% of setting	-3.0	0.9	
		7200 - 8000	-0.7-4.5% of setting	-2.7	0.2+2.0% of setting	
	80.25 - 95 dB	1 - 2000	-0.4-0.5% of setting	3.7	-3.6+10.0% of setting	
		2000 - 4000	-0.6-1.0% of setting	2.8	-3.0+9.0% of setting	
		4000 - 6000	3.0-9.0% of setting	-2.3	2.0+0.5% of setting	
		6000 - 7200	3.6-10.0% of setting	-3.7	0.9	
		7200 - 8000	-0.7-4.5% of setting	-2.9	-1.7+6.0% of setting	
Insertion Loss	0 dB	1 - 2000	-	4.2	6.0	dB
		2000 - 4000	-	5.6	8.0	
		4000 - 6000	-	7.4	9.0	
		6000 - 7200	-	8.3	11.5	
		7200 - 8000	-	10.0	12.0	
Isolation	In-Out (within a channel) ³	1 - 8000	-	100	-	dB
	Between channels ⁴	1 - 8000	100	125	-	
Return Loss	0 - 95 dB	1 - 2000	-	23	-	dB
		2000 - 4000	-	21	-	
		4000 - 6000	-	19	-	
		6000 - 7200	-	14	-	
		7200 - 8000	-	11	-	

- Attenuator RF ports support simultaneous, bi-directional signal transmission, within the specified power limits. However the specifications are guaranteed for the RF In and RF Out as noted on the label. There may be minor changes in performance when injecting signals to the RF Out port.
- Max accuracy defined as $\pm[\text{absolute error} + \% \text{ of attenuation setting}]$. For example, if a 20 dB attenuation at a given frequency is defined as max accuracy of $\pm(0.5 + 3.0\%)$ then the maximum error at those settings will be: $\pm(0.5 + 0.03 \times 20) = \pm(0.5 + 0.6) = \pm 1.1$ dB.
- Isolation within a channel is defined as max attenuation plus insertion loss; this is the path loss through the attenuator when initially powered up. After a brief delay (~0.5 sec typically) the attenuator will revert to a user defined "power-up" state (either max attenuation or a pre-set value).
- Isolation between channels may drop to 95 dB when both channels being tested are at 0 dB attenuation state.



ELECTRICAL SPECIFICATIONS¹, +25°C (CONTINUED)

Parameter	Conditions	Frequency (MHz)	Min.	Typ.	Max.	Unit
IP3 Input ⁵	0 dB setting (P _{IN} = +5 dBm)	1 - 5000	-	+53	-	dBm
		5000 - 8000	-	+48	-	
Attenuation Transition Time ⁶	-	1 - 8000	-	650	-	ns
Minimum Dwell Time ⁷	High-speed mode	1 - 8000	-	600	-	μs
Channel Synchronization ⁸	-	1 - 8000	-	400	-	μs
Supply Voltage (V _{DC}) ⁹	USB port	-	4.75	5.00	5.25	V
Supply Current (I _{DC})		-	-	210	330	mA
Supply Voltage (V _{DC}) ⁹	LAN port ¹⁰	-	37	48	57	V
Supply Current (I _{DC})		-	-	40	50	mA
Operating RF Input Power ^{1,11}	0 - 95 dB	1 - 50	-	-	Note 12	dBm
		50 - 8000	-	-	+28	

5. Tested with 1 MHz span between signals.

6. Attenuation Transition Time is specified as the time between starting to change the attenuation state and settling on the requested attenuation state.

7. Minimum Dwell Time is the minimum time from settling on one attenuation level to settling to a new one in response to command (without communication protocol delays).

8. Channel Synchronization is the delay between the first and last attenuator transitions beginning, in response to a command to set all channels.

9. Power supply can be provided from either USB or LAN port regardless of control method used.

10. Compliant with IEEE 802.3af mode A and mode B.

11. Total Operating Input Power from both RF In and RF Out ports. Compression level not noted as it exceeds max safe operating power level.

12. Derates linearly from +28 dBm at 50 MHz to +17 dBm at 1 MHz.

ABSOLUTE MAXIMUM RATINGS ^{13,14}

Operating Temperature	0°C to +50°C	
Storage Temperature	-20°C to +85°C	
DC Voltage @ RF Ports	16 V	
V _{USB} MAX	6 V	
V _{LAN} MAX	57 V	
Max RF Power	1 - 50 MHz	Derates linearly from +33 dBm at 50 MHz to +20 dBm at 1 MHz
	50 - 8000 MHz	+33 dBm

13. Permanent damage may occur if any of these limits are exceeded.

14. Operating in the range between operating power limits and absolute maximum ratings for extended periods of time may result in reduced life and reliability.



TYPICAL PERFORMANCE GRAPHS

Attenuation Accuracy @ 0°C vs. Frequency over Attenuation settings

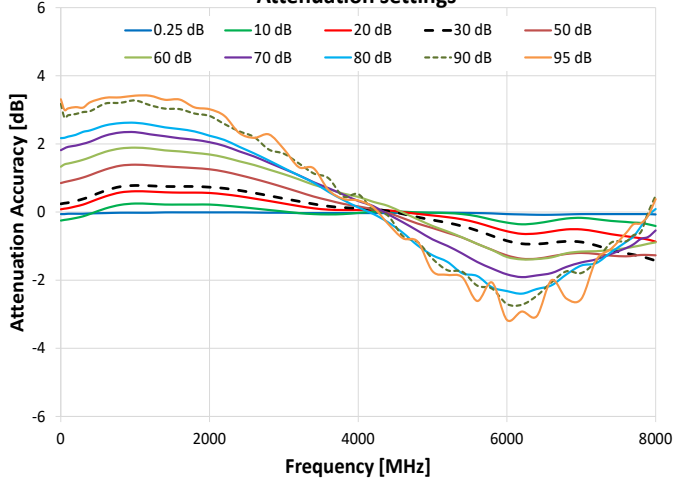

Attenuation Accuracy @ 30 dB vs. Frequency at all Channels

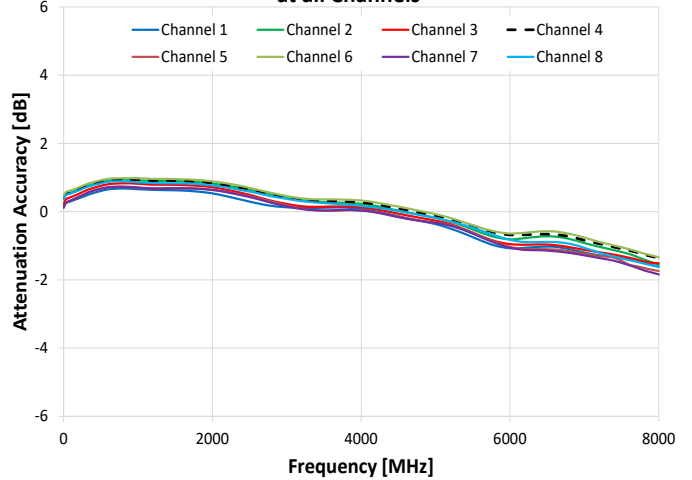

Attenuation Accuracy @ 25°C vs. Frequency over Attenuation settings

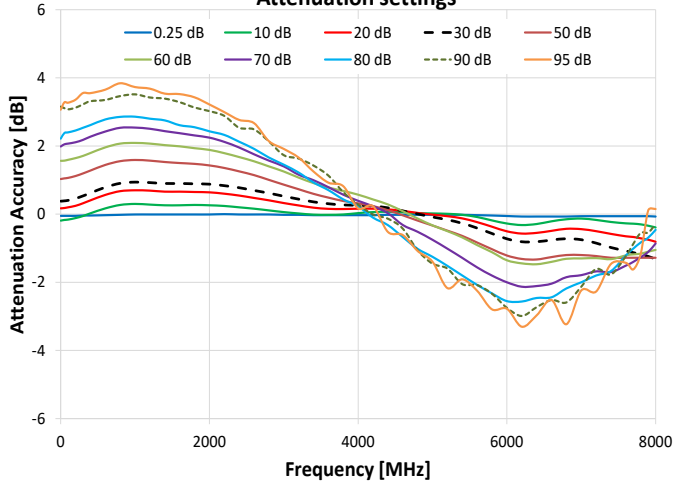

Attenuation Accuracy @ 60 dB vs. Frequency at all Channels

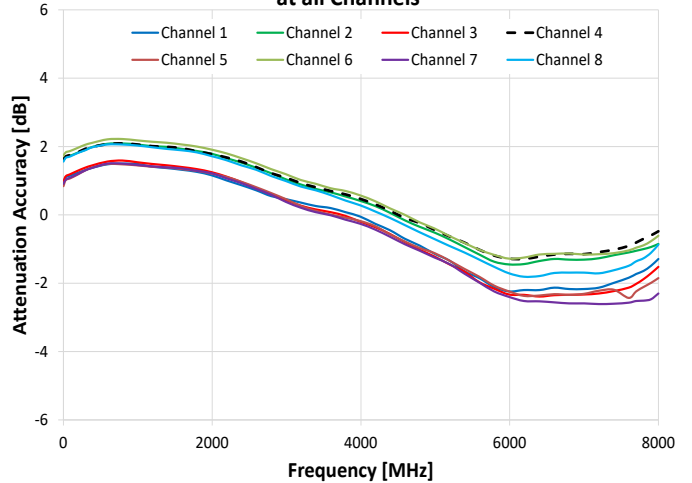

Attenuation Accuracy @ 50°C vs. Frequency over Attenuation settings

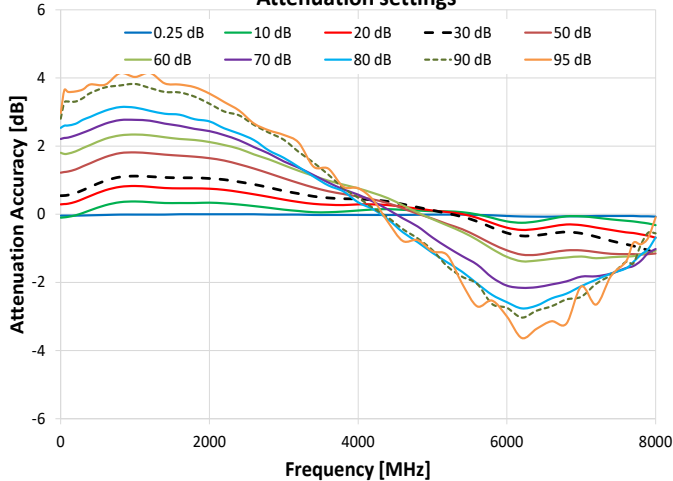

Attenuation Accuracy @ 90 dB vs. Frequency at all Channels

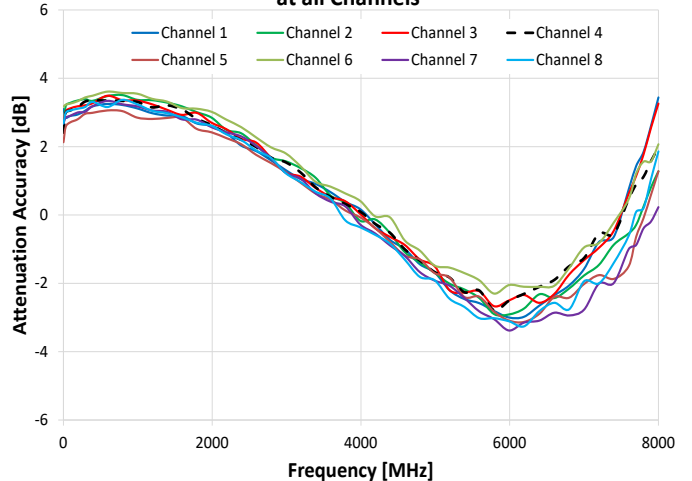



TYPICAL PERFORMANCE GRAPHS (CONTINUED)

Attenuation relative to Insertion Loss vs. Frequency (at 2 dB steps)

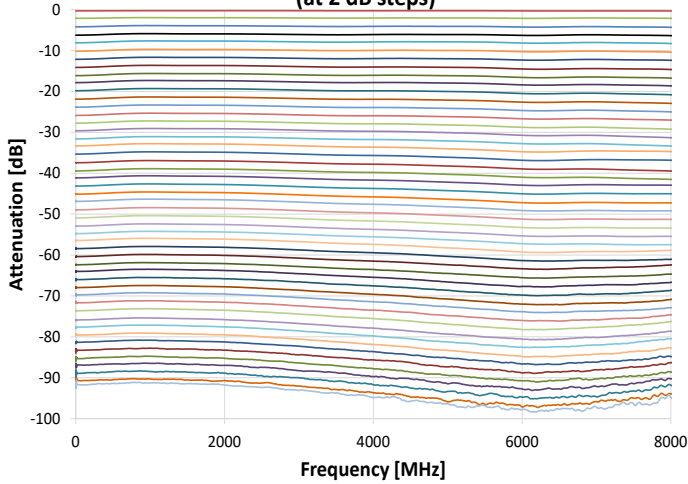

Insertion Loss vs. Frequency over Temperature

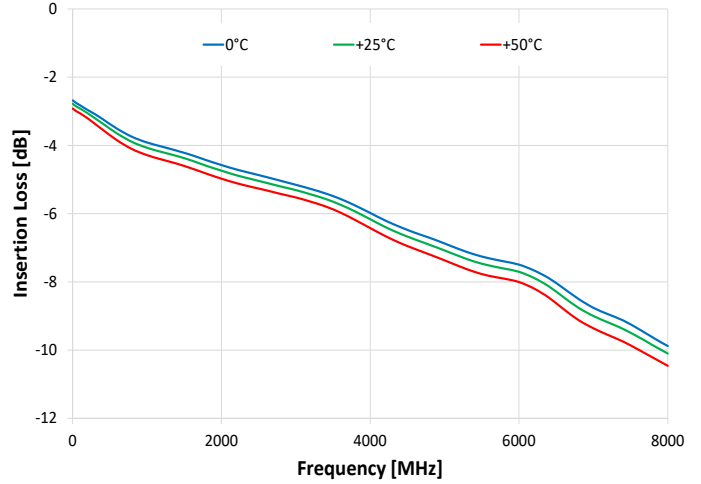

Return Loss In vs. Frequency over Attenuation settings

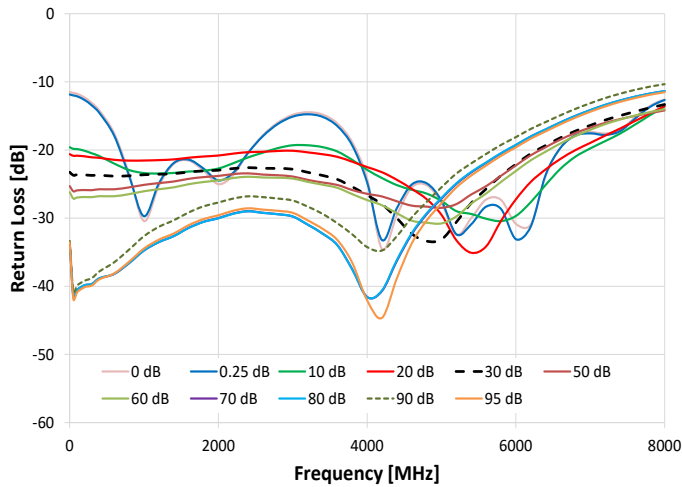

Return Loss Out vs. Frequency over Attenuation settings

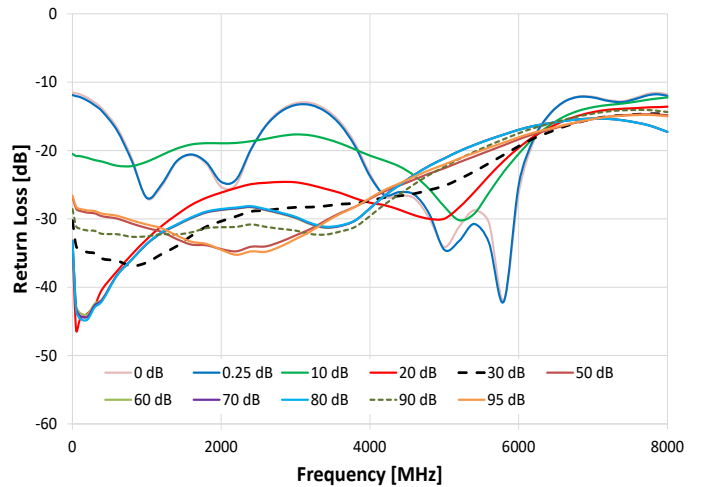

Isolation between Channels vs. Frequency over Attenuation settings

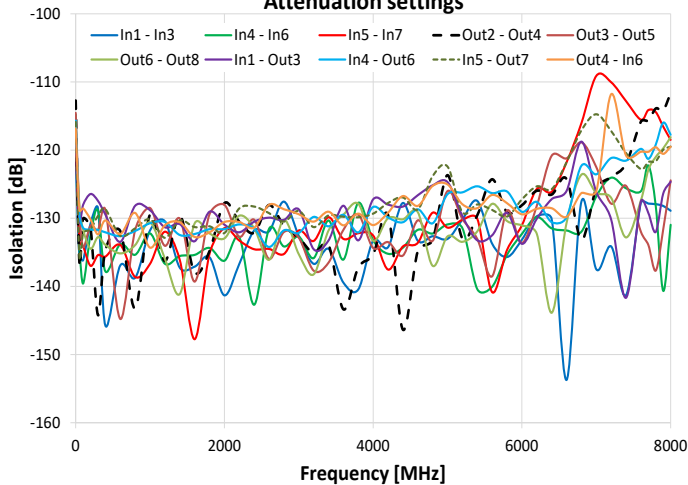

IP3 @ 0 dB Attenuation vs. Frequency over Temperature

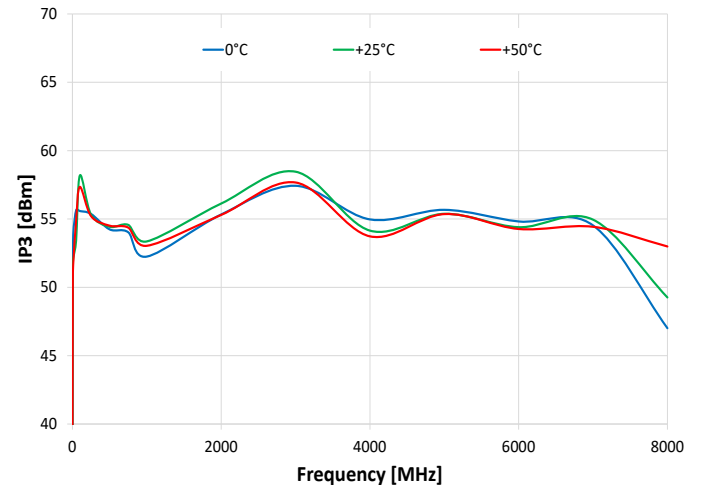



CONTROL INTERFACES

Ethernet Control	Supported Protocols	TCP / IP, HTTP, Telnet, SSH, DHCP, UDP (limited)
	Max Data Rate	100 Mbps (100 Base-T Full Duplex)
USB Control	Protocol	HID (Human Interface Device) - High-speed
	Min Communication Time ¹⁵	400 µsec typical (full transmit/receive cycle)

15. USB Min Communication Time is based on the polling interval of the USB HID protocol (125 µsec polling interval, 64 bytes per packet), medium CPU load and no other high-speed USB devices using the USB bus.

SOFTWARE & DOCUMENTATION

Mini-Circuits' full software and support package including user guide, Windows GUI, API, programming manual and examples can be downloaded free of charge (refer to the last page for the download path).

A comprehensive set of software control options is provided:

- GUI for Windows – Simple software interface for control via Ethernet and USB.
- Programming / automation via Ethernet:
 - Complete set of control commands which can be sent via any supported protocol.
 - Simple to implement in the majority of modern programming environments.
- Programming / automation via USB:
 - DLL files provide a full API for Windows with a set of intuitive functions which can be implemented in any programming environment supporting .Net Framework or ActiveX.
 - Direct USB programming is possible in any other environment (not supporting .Net or ActiveX).

Please contact testsolutions@minicircuits.com for support.

MINIMUM SYSTEM REQUIREMENTS

GUI	Windows 7 or later
USB API DLL	Windows 7 or later and programming environment with ActiveX or .NET support
USB Direct Programming	Linux, Windows 7 or later
Hardware	Intel i3 (or equivalent) or later



GRAPHICAL USER INTERFACE (GUI) FOR WINDOWS - KEY FEATURES

- Connect via USB or Ethernet to control the module.
- Password protected access for safe remote usage over Ethernet.

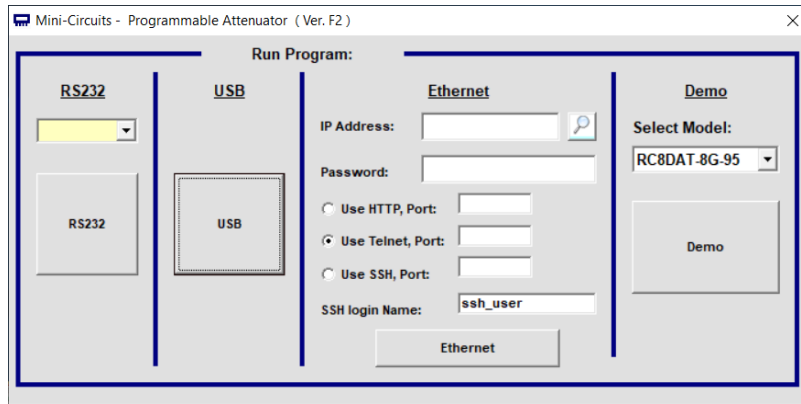

- Run GUI in "demo mode" to evaluate software without a hardware connection.
- Manual attenuation setting.
- Sweep and Hop attenuation sequences directed from the PC, or entire sequence loaded into the module.
- Attenuator address configuration and firmware upgrade.
- Attenuation at power up may be set to selected attenuation level or last attenuation state recorded.

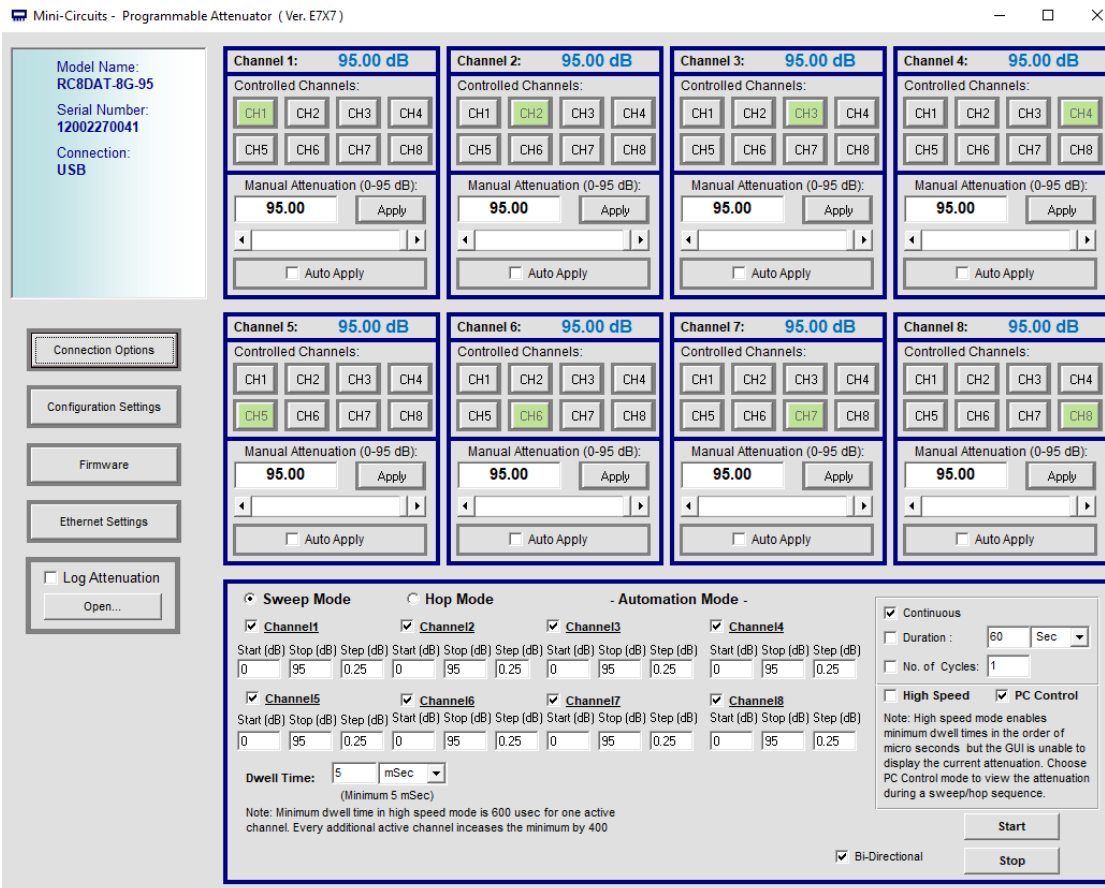



PROGRAMMABLE ATTENUATOR RESPONSE TO COMMUNICATION INTERRUPT

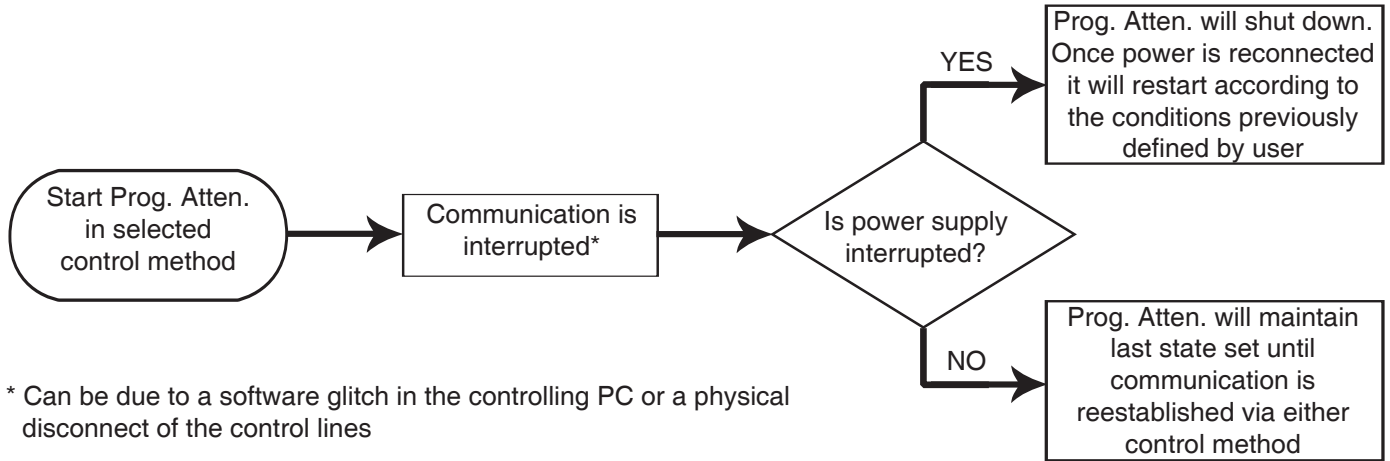

BLOCK DIAGRAM

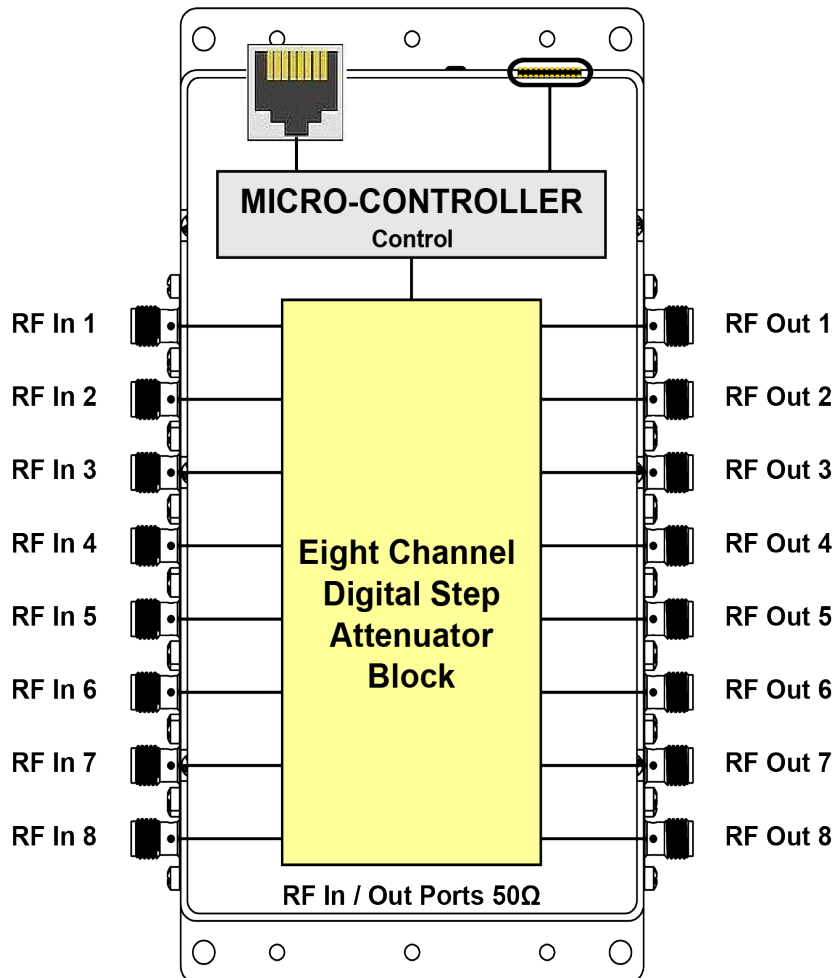

Simultaneous, bidirectional RF signal transmission with symmetrical performance



CASE STYLE DRAWING (QE2899)

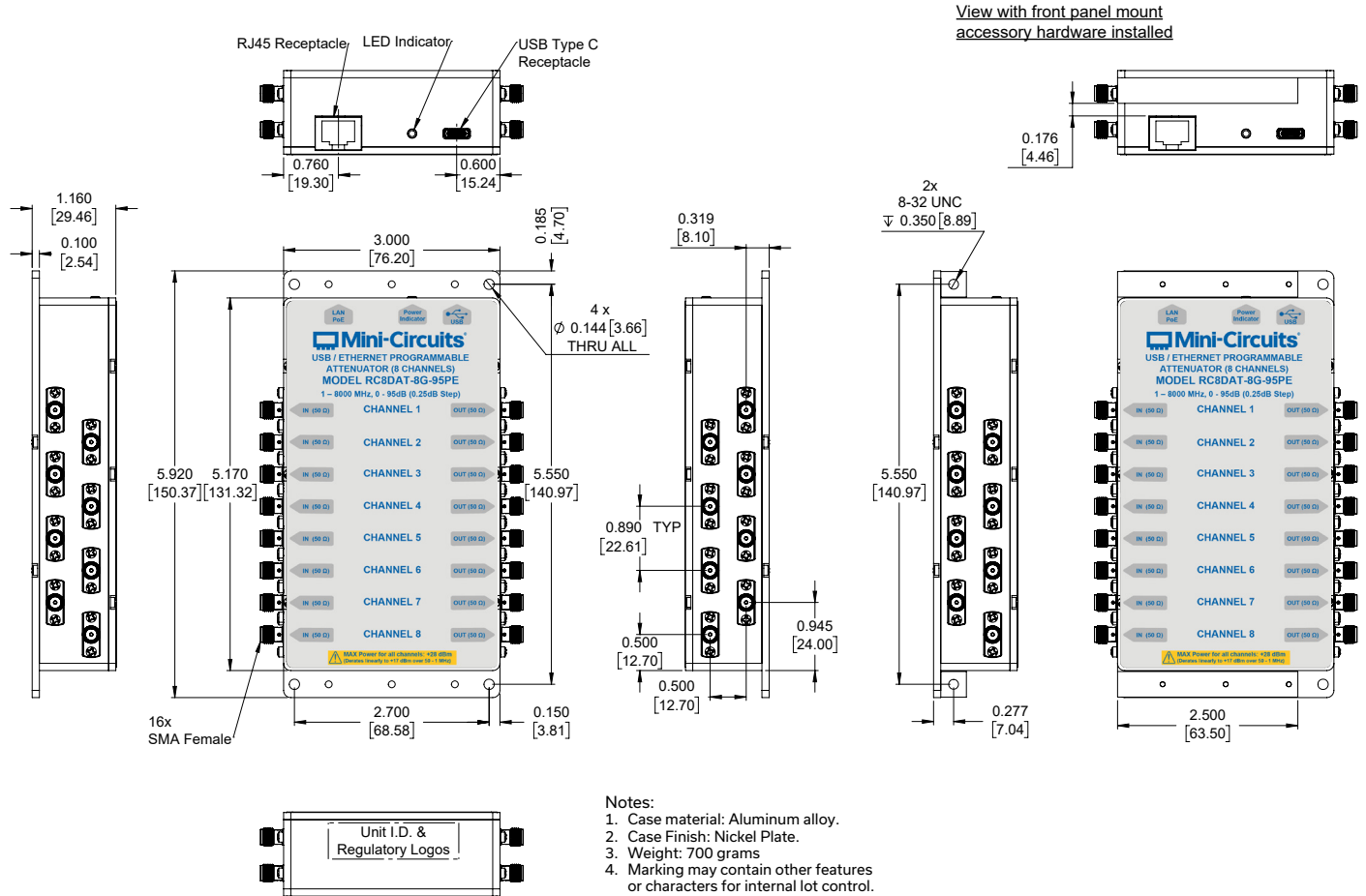

CONNECTIONS

Port Name	Connector Type	Function
In (50Ω) & Out (50Ω)	SMA female	RF input / output port
USB	USB Type C female	USB control & DC power
Ethernet	RJ45 Socket	LAN control & DC power



BRACKET MOUNTING INSTRUCTIONS

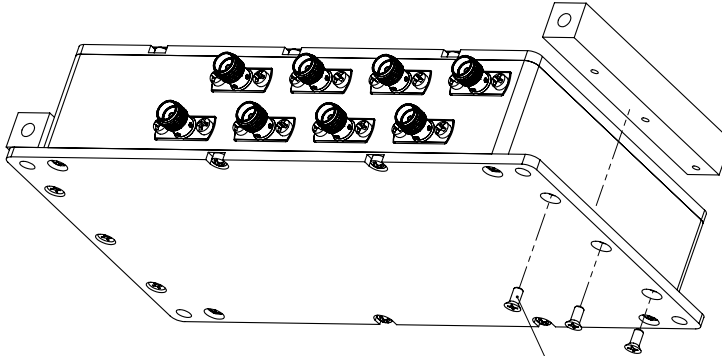

Instruction for installing front panel hardware:

1. Tool required: Phillips head screw driver.
2. Align bracket over counter sink holes.
3. Secure with screws provided.

3x each side.
Flathead screws provided.

Note: Bracket can be mounted facing either side.

CONNECTION DIAGRAMS

USB CONTROL

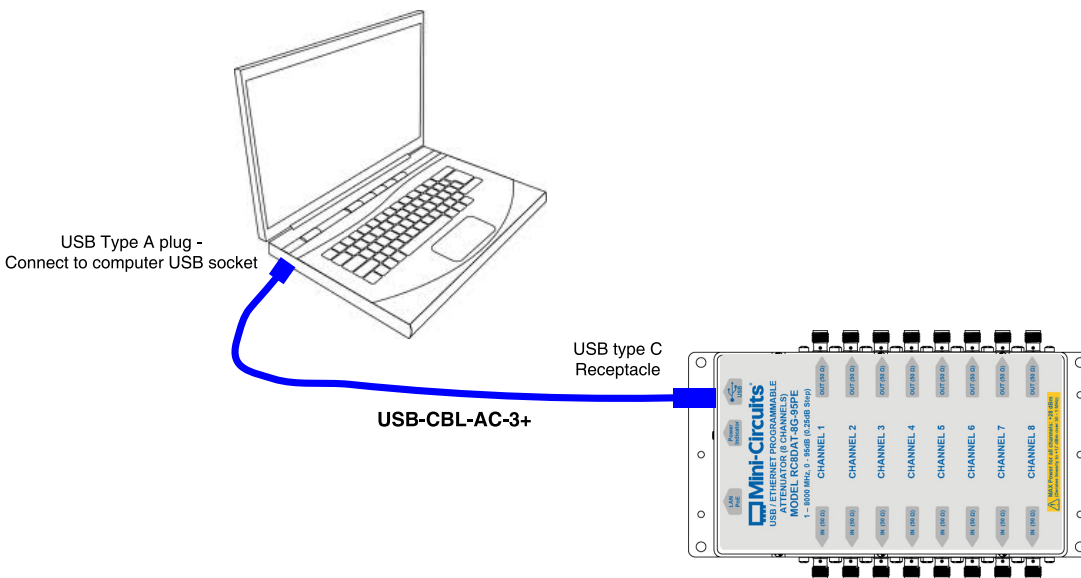



CONNECTION DIAGRAMS (CONTINUE)

ETHERNET CONTROL & USB POWER (USING POWER ADAPTER)

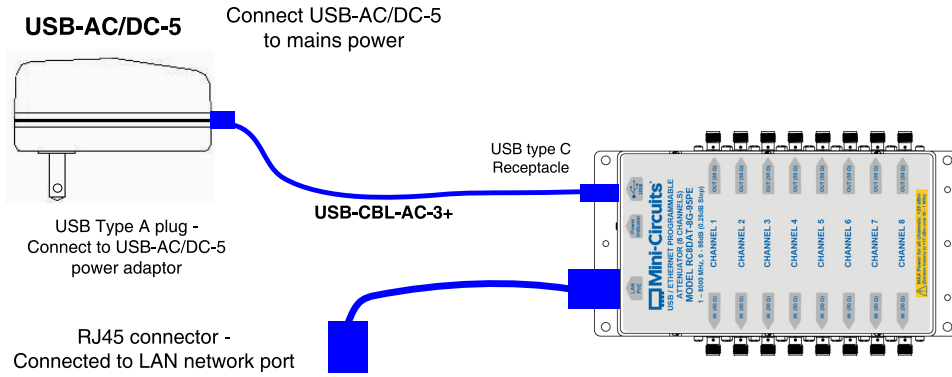

ETHERNET POWER & USB CONTROL

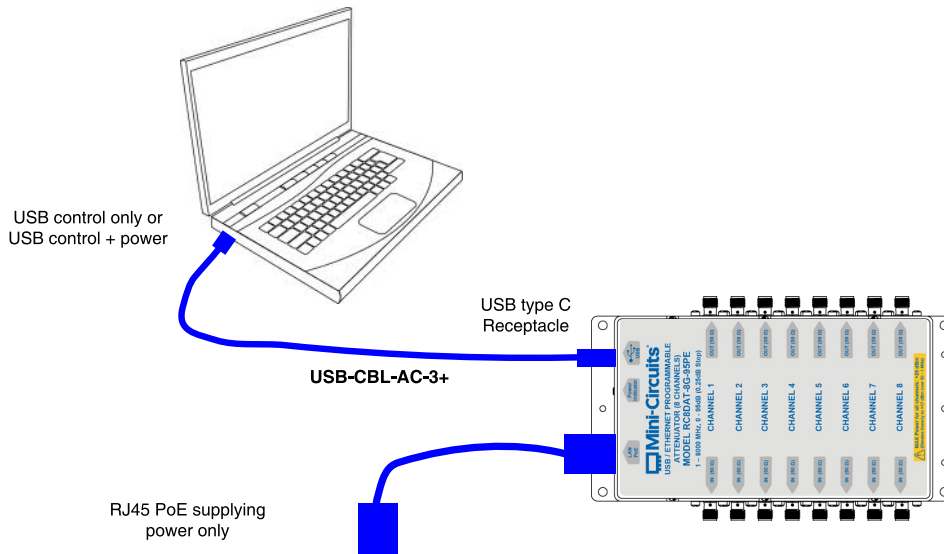

ETHERNET POWER & CONTROL

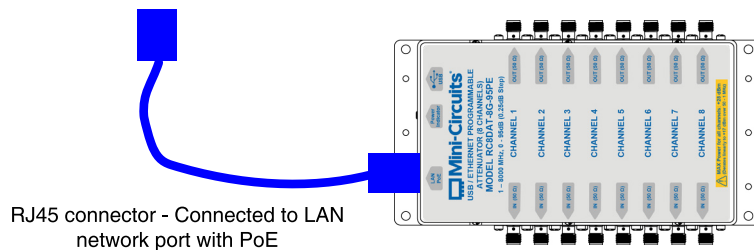





Programmable Attenuator **RC8DAT-8G-95PE**

DETAILED MODEL INFORMATION IS AVAILABLE ON OUR WEBSITE [CLICK HERE](#)



Performance Data & Graphs	Data Graphs
Case Style	QE2899
Environmental Rating	ENV55T1
Software, User Guide & Programming Manual	https://www.minicircuits.com/softwaredownload/patt.html
Regulatory Compliance	<p>Refer to user guide for compliance information</p>  <p>https://www.minicircuits.com/app/AN49-011.pdf</p>
Support	testsolutions@minicircuits.com

INCLUDED ACCESSORIES ¹⁶

	Part No.	Qty.	Description
	USB-CBL-AC-3+	1	3.3 ft (1.0 m) USB cable: USB type A (Male) to USB type C (Male)
	BKT-355-05+	1	Bracket kit including two 2.50" x 0.35" side mounting brackets, screws and washers

16. Additional quantities are available for purchase as optional accessories.

OPTIONAL ACCESSORIES

	Part No.	Description
	USB-CBL-AA-3+	3.3 ft (1.0 m) USB extension Cable: USB type A (Male) to USB type A (Female)
	CBL-RJ45-MM-5+	5.0 ft (1.5 m) Ethernet cable: RJ45 (Male) to RJ45 (Male) Cat 5E cable
	USB-AC/DC-5	AC/DC +5V power adaptor with USB connector ^{17, 18}

17. The power adaptor may be used to provide additional power via USB port when connecting several units in daisy chain control.

18. Includes power plugs for US, UK, EU, IL, AU & China. Plugs for other countries are also available. If you need a power cord for a country not listed, please contact testsolutions@minicircuits.com

NOTES:

- A. Performance and quality attributes and conditions not expressly stated in this specification document are intended to be excluded and do not form a part of this specification document.
- B. Electrical specifications and performance data contained in this specification document are based on Mini-Circuit's applicable established test performance criteria and measurement instructions.
- C. The parts covered by this specification document are subject to Mini-Circuits standard limited warranty and terms and conditions (collectively, "Standard Terms"); Purchasers of this part are entitled to the rights and benefits contained therein. For a full statement of the Standard Terms and the exclusive rights and remedies thereunder, please visit Mini-Circuits' website at <https://www.minicircuits.com/terms/viewterm.html>