

# RFPA2026

## 3-Stage Power Amplifier Module, 2W 700MHz to 2700MHz

The RFPA2026 is a 3-stage HBT power amplifier module with high gain and excellent efficiency. External matching and bias control allows the RFPA2026 to be optimized for various applications including small-cell power amplifiers and ultra-linear driver amplifiers within 700MHz to 2700MHz. Users can also bypass the first stage to reduce gain and power consumption.

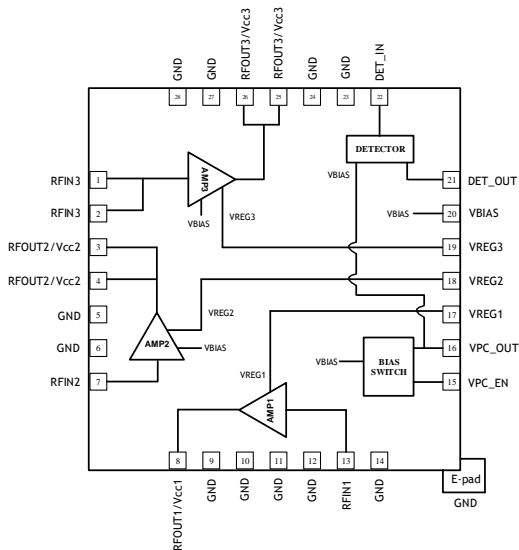

Functional Block Diagram

### Ordering Information

RFPA2026SQ	Sample bag with 25 pieces
RFPA2026SR	7" Reel with 100 pieces
RFPA2026TR13	13" Reel with 2500 pieces
RFPA2026PCK-410	728MHz to 768MHz PCBA with 5-piece sample bag
RFPA2026PCK-411	2110MHz to 2170MHz PCBA with 5-piece sample bag
RFPA2026PCK-412	2580MHz to 2690MHz PCBA with 5-piece sample bag



Package: MCM, 28-pin,  
6.0mm x 6.0mm

### Features

- WCDMA Power at 2140MHz = 24dBm with -45dBc ACPR
- Flexible External Matching for Band Selection
- Gain = 38dB at 2140MHz
- P1dB = 33dBm at 2140MHz
- 5V Supply
- Independent Bias Control for Each Stage
- Power-down Capability
- Integrated Power Detector

### Applications

- 2G, 3G, and 4G Air Interfaces
- Picocell, Femtocell Power Amplifier Module
- Driver Amplifier for Commercial Wireless Infrastructure

## Absolute Maximum Ratings

Parameter	Rating	Unit
Supply Voltage ( $V_{DD}$ )	7.0	V
Amp1 DC Current ( $I_{CC1}$ )	100	mA
Amp2 DC Current ( $I_{CC2}$ )	250	mA
Amp3 DC Current ( $I_{CC3}$ )	1500	mA
CW Input Power, 50Ω, 2-Stage Operation	18	dBm
CW Input Power, 50Ω, 3-Stage Operation	18	dBm
Modulated (WCDMA) Input Power, 6:1 Output VSWR, 2-Stage Operation	10	dBm
Modulated (WCDMA) Input Power, 6:1 Output VSWR, 3-Stage Operation	18	dBm
Junction Temperature	175	°C
Storage Temperature Range	-40 to +150	°C
ESD Rating - Human Body Model (HBM)	Class 1A	
Moisture Sensitivity Level	MSL3	

### Notes:

1. The maximum ratings must all be met simultaneously
2.  $P_{DISS} = P_{DC} + P_{RFIN} - P_{RFOUT}$
3.  $T_J = T_L + P_{DISS} * R_{TH}$



Caution! ESD sensitive device.



RFMD Green: RoHS status based on EU Directive 2011/65/EU (at time of this document revision), halogen free per IEC 61249-2-21, < 1000ppm each of antimony trioxide in polymeric materials and red phosphorus as a flame retardant, and <2% antimony in solder.

Exceeding any one or a combination of the Absolute Maximum Rating conditions may cause permanent damage to the device. Extended application of Absolute Maximum Rating conditions to the device may reduce device reliability. Specified typical performance or functional operation of the device under Absolute Maximum Rating conditions is not implied.

## Recommended Operating Condition

Parameter	Specification			Unit
	Min	Typ	Max	
Operating Temperature Range	-40		+85	°C
Operating Junction Temperature >1E6 Hours, MTTF			160	°C
Collector Voltage <sup>1</sup>	4.75	5	5.25	V

Note 1: Max recommended operational collector voltage

## Nominal Operating Parameters

Parameter	Specification			Unit	Condition
	Min	Typ	Max		
<b>728MHz to 768MHz</b>					<b><math>V_{CC} = 5.0V</math>, Temp = 25°C, Optimized for -45dBc ACPR at rated power</b>
Frequency		748		MHz	
Input Power ( $P_{IN}$ )			-4	dBm	Max recommended continuous input power, $V_{CC} = 5.0V$ , Load VSWR = 2:1
Gain		33.5		dB	Stage 1 bypassed
ACPR		-48		dBc	RF Output Power = 24dBm, WCDMA 3GPP 3.5, test model 1, 64 DPCH
P1dB		33		dBm	
Output IP3		44		dBm	At 21dBm per tone, 1MHz spacing with WCDMA ACPR tune

Parameter	Specification			Unit	Condition
	Min	Typ	Max		
<b>728MHz to 768MHz</b>					<b>V<sub>CC</sub> = 5.0V, Temp = 25°C, Optimized for -45dBc ACPR at rated power</b>
Detector Output Voltage		1.1		V	CW RF output power = 24dBm with 0.3pF coupling capacitor
Input Return Loss		20		dB	
Output Return Loss		20		dB	
Noise Figure		4.5		dB	
<b>2.11GHz to 2.17GHz</b>					<b>V<sub>CC</sub> = 5.0V, Temp = 25°C, Optimized for -45dBc ACPR at rated power</b>
Frequency		2.14		GHz	
Input Power (P <sub>IN</sub> )			0	dBm	Max recommended continuous input power, V <sub>CC</sub> = 5.0V, Load VSWR = 2:1
Gain	34	38	42	dB	
ACPR		-48	-42	dBc	RF Output Power = 24dBm, WCDMA 3GPP 3.5, test model 1, 64 DPCH
P1dB		33		dBm	
Output IP3		46		dBm	At 21dBm per tone, 1MHz spacing with WCDMA ACPR tune
Detector Output Voltage		1.0		V	CW RF output power = 24dBm with 0.2pF coupling capacitor
Input Return Loss		17		dB	
Output Return Loss	25			dB	
Noise Figure		5.2		dB	
<b>2.58GHz to 2.69GHz</b>					<b>V<sub>CC</sub> = 5.0V, Temp = 25°C, Optimized for -45dBc ACPR at rated power</b>
Frequency		2.65		GHz	
Input Power (P <sub>IN</sub> )			-5	dBm	Max recommended continuous input power, V <sub>CC</sub> = 5.0V, Load VSWR = 2:1
Gain		37		dB	
ACPR		-48		dBc	RF Output Power = 24dBm, WCDMA 3GPP 3.5, test model 1, 64 DPCH
P1dB		33		dBm	
Output IP3		45		dBm	At 21dBm per tone, 1MHz spacing with WCDMA ACPR tune
Detector Output Voltage		1.1		V	CW RF output power = 24dBm with 0.2pF coupling capacitor
Input Return Loss		16		dB	
Output Return Loss		11		dB	
Noise Figure		5.6		dB	
<b>Power Supply</b>					<b>Temp = 25°</b>
Amp1 Quiescent Current	37	48	57	mA	At V <sub>CC1</sub> = V <sub>BIAS</sub> = 5V, VPC_EN = 1.8V, off for 750MHz band
Amp2 Quiescent Current	90	115	130	mA	At V <sub>CC2</sub> = V <sub>BIAS</sub> = 5V, VPC_EN = 1.8V
Amp3 Quiescent Current	420	460	525	mA	At V <sub>CC3</sub> = V <sub>BIAS</sub> = 5V, VPC_EN = 1.8V
V <sub>BIAS</sub>	4.75	5	5.25	V	V <sub>BIAS</sub> = V <sub>CC</sub> under normal operating conditions

Parameter	Specification			Unit	Condition
	Min	Typ	Max		
<b>Power Supply – Continued</b>					<b>Temp = 25°</b>
Enable Voltage HIGH (VPC_EN)	1.6	2.5	5.25	V	Normal operation
Enable Voltage LOW (VPC_EN)		0	0.8		Module shutdown
Enable Current		115		μA	VPC_EN = 2.5V
Shutdown Leakage Current		125	375	μA	V <sub>CC</sub> = V <sub>BIAS</sub> = 5V, VPC_EN = 0.5V
Thermal Resistance		19		°C/W	Junction-to-back side of IC

**Typical Performance:  $V_{CC1} = V_{CC2} = V_{CC3} = V_{BIAS} = V_{REG} = 5V$ ,  $V_{PC\_EN} = 1.8V$  728MHz to 768MHz Application Circuit**

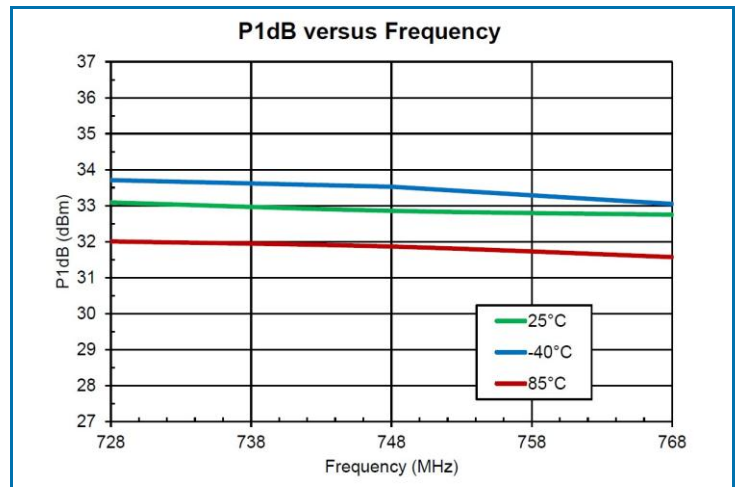
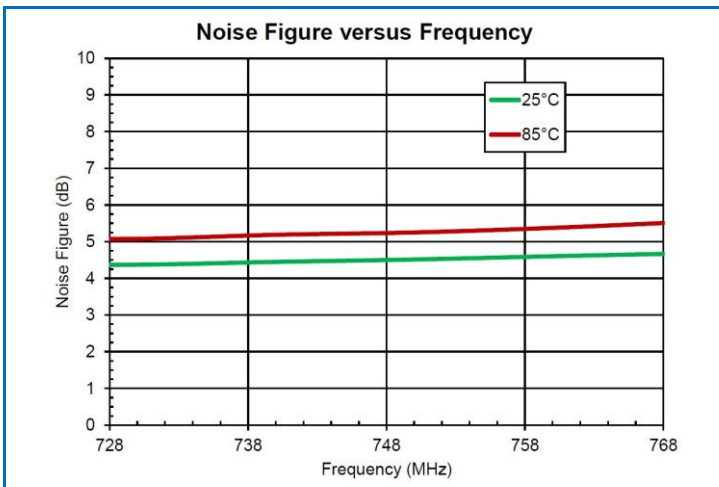
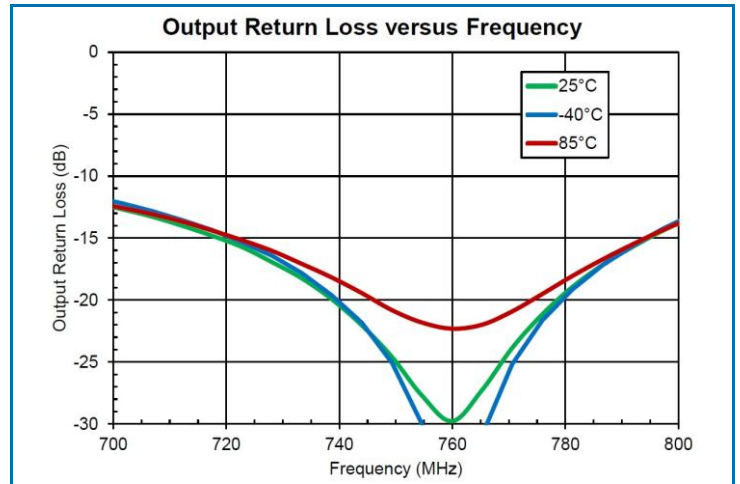
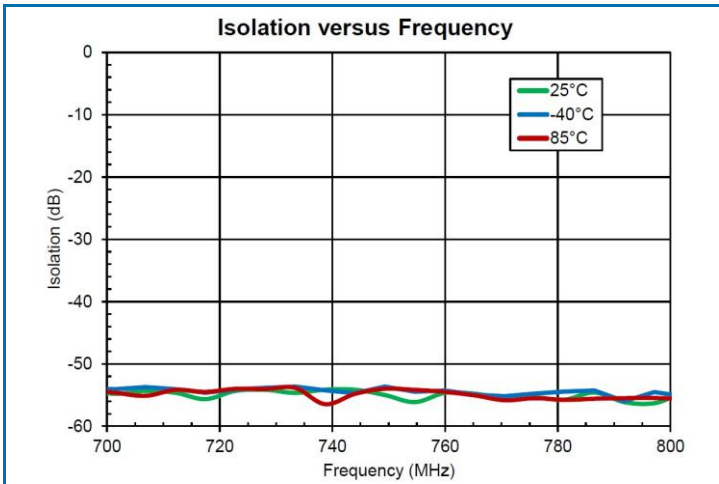
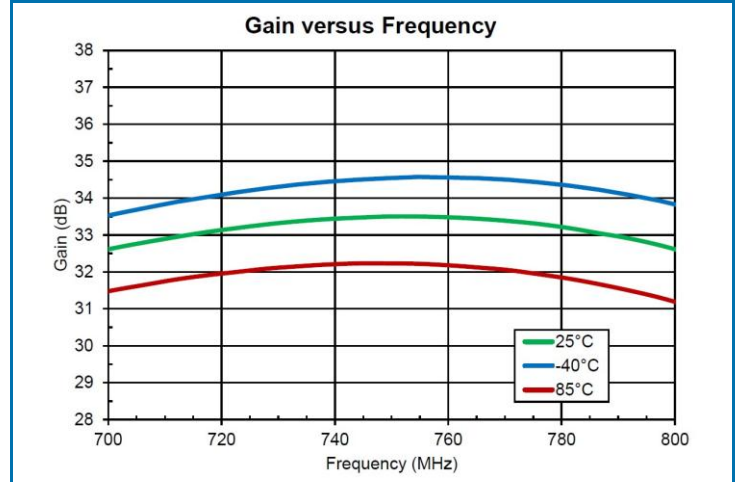
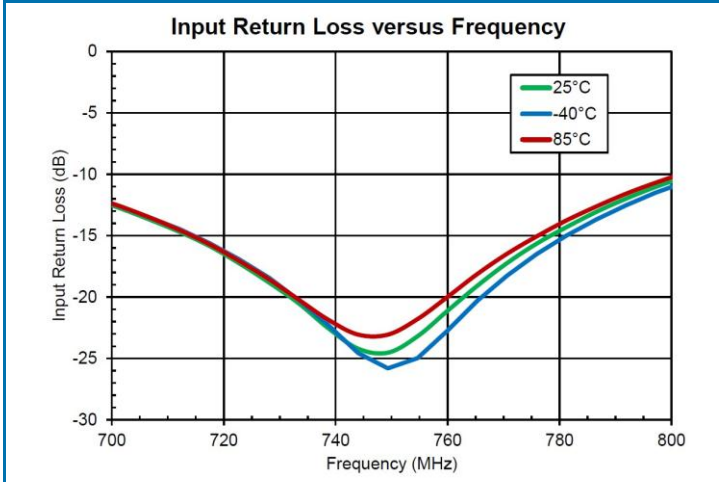

**Typical Performance:  $V_{CC1} = V_{CC2} = V_{CC3} = V_{BIAS} = V_{REG} = 5V$ ,  $V_{PC\_EN} = 1.8V$  728MHz to 768MHz Application Circuit**

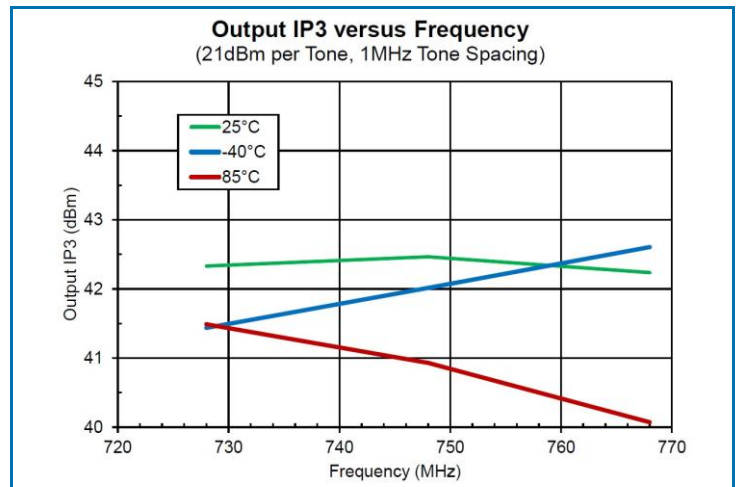
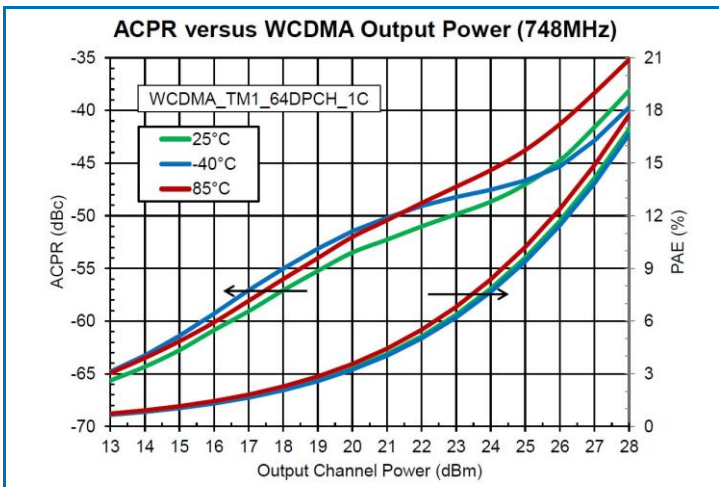
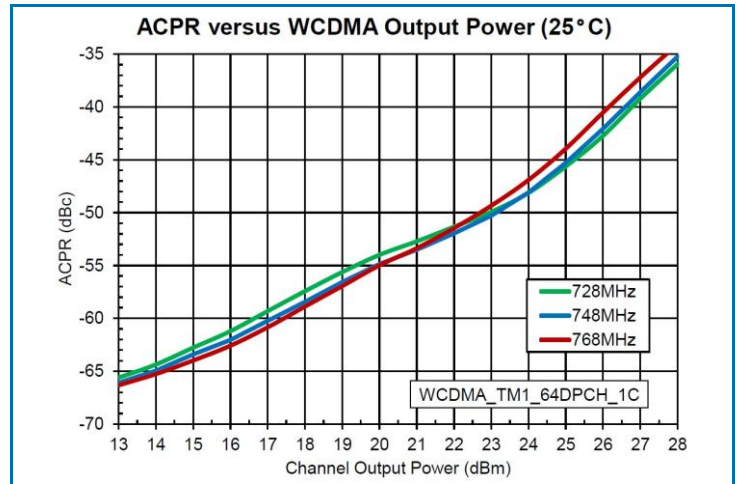
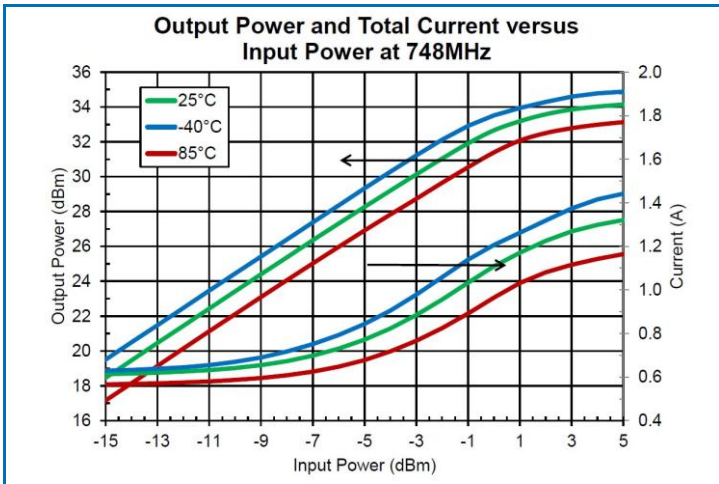
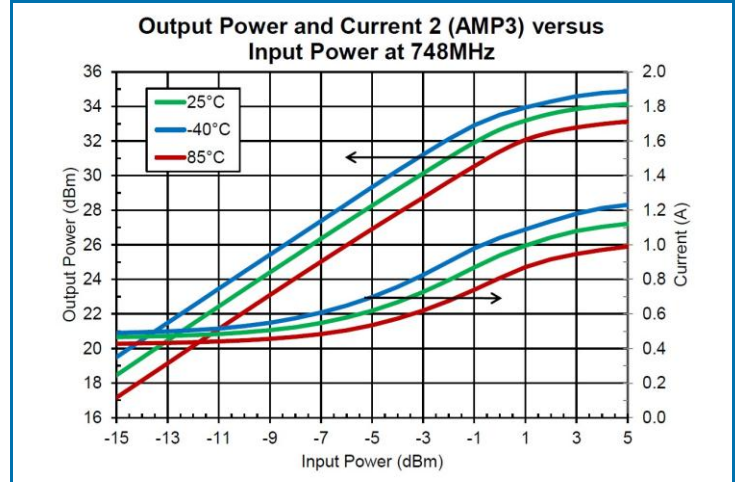
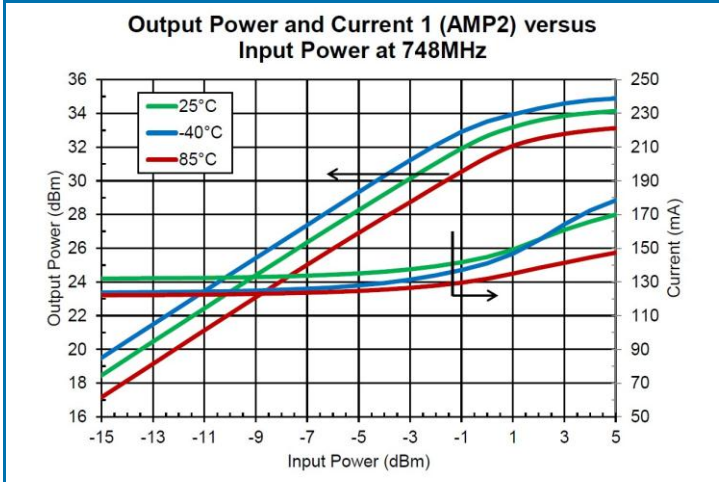

**Typical Performance:  $V_{CC1} = V_{CC2} = V_{CC3} = V_{BIAS} = V_{REG} = 5V$ ,  $V_{PC\_EN} = 1.8V$  728MHz to 768MHz Application Circuit**

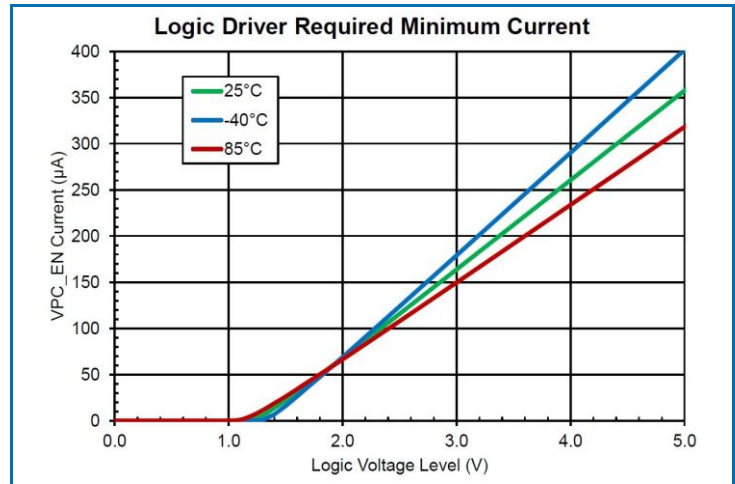
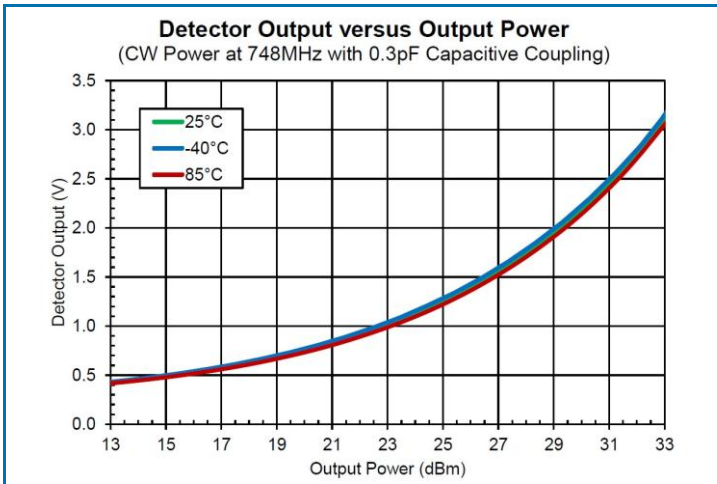
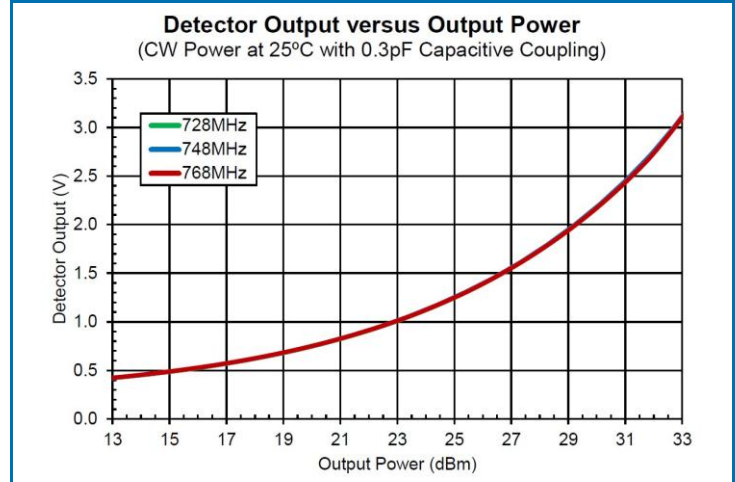
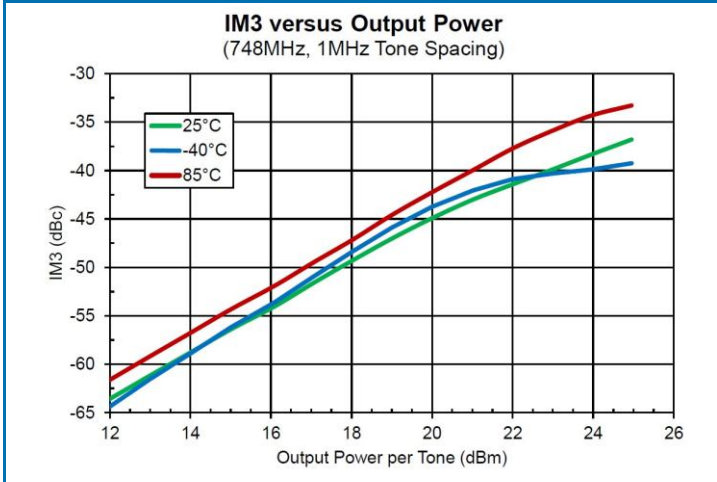

Evaluation Board Schematic 728MHz to 768MHz Application Circuit

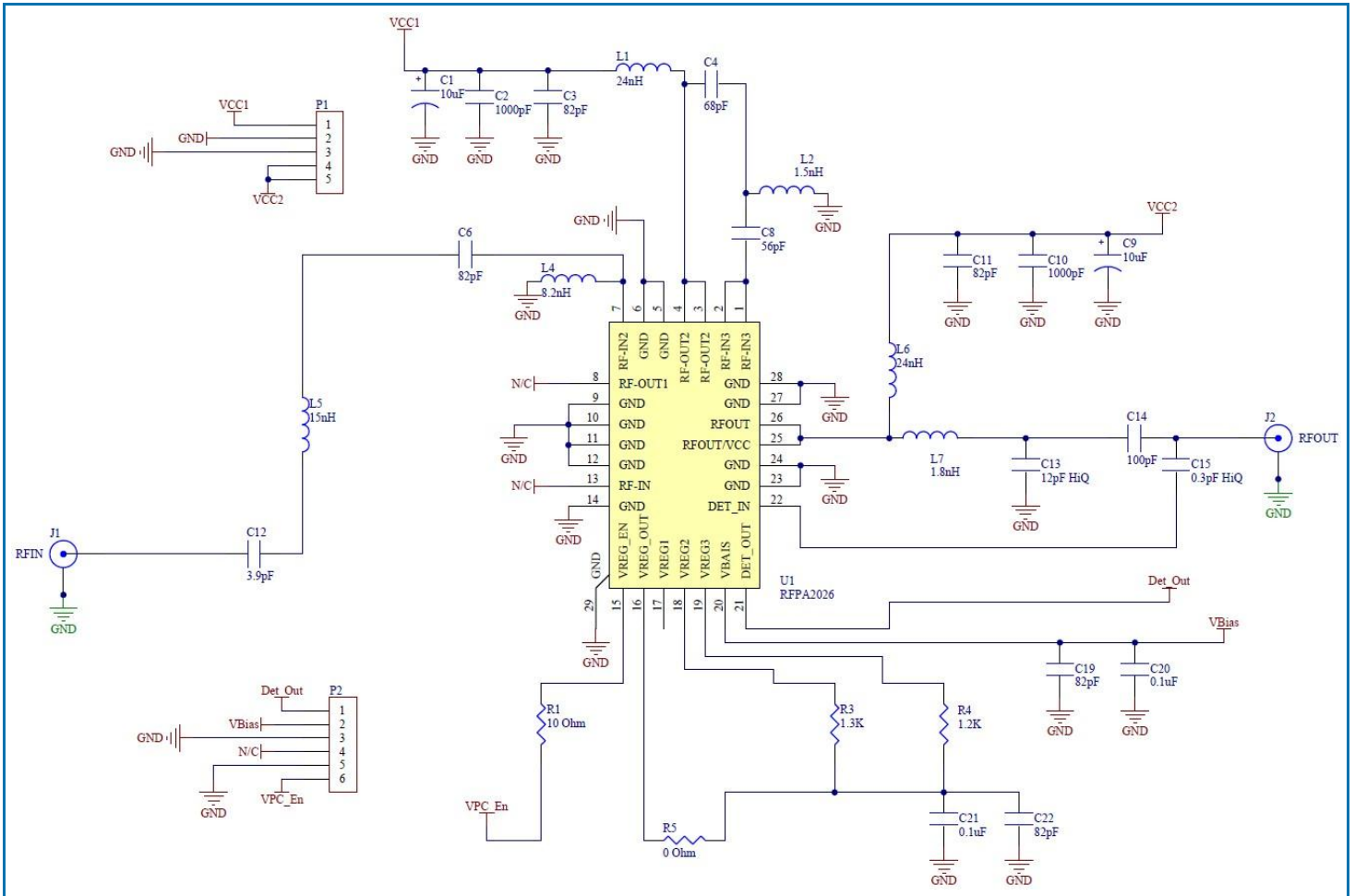



## Evaluation Board Bill of Materials (BOM) 728MHz to 768MHz Application Circuit

Description	Reference Designator	Manufacturer	Manufacturer's P/N
RFPA2026 Evaluation Board		Dynamic Details (DDI) Toronto	RFPA2026-411(A)
700MHz to 2700MHz PA, 2W, 35dB Gain, Ext. Match	U1	RFMD	RFPA2026
CAP, 10 $\mu$ F, 10%, 10V, TANT-A	C1, C9	AVC Corporation	TAJA106K010RNJ
CAP, 1000pF, 10%, 50V, X7R, 0402	C2, C10	Taiyo Yuden (USA), Inc.	RM UMK105BJ102KV-F
CAP, 82pF, 5%, 50V, COG, 0402	C3, C6, C11, C19, C22	Murata Electronics	GRM1555C1H820JZ01D
CAP, 68pF, 5%, 50V, COG, 0402	C4	Murata Electronics	GRM1555C1H680JZ01D
CAP, 56pF, 5%, 50V, COG, 0402	C8	Murata Electronics	GRM1555C1H560JZ01D
CAP, 3.9pF, +/-0.25pF, 50V, COG, 0402	C12	Murata Electronics	GRM1555C1H3R9CA01D
CAP, 12pF, 5%, 50V, HI-Q, 0402	C13	Murata Electronics	GJM1555C1H120JB01E
CAP, 100pF, 5%, 50V, COG, 0402	C14	Murata Electronics	GRM1555C1H101JA01D
CAP, 0.3pF, +/-0.05pF, 50V, HI-Q, 0402	C15	Murata Electronics	GJM1555C1HR30WB01D
CAP, 0.1 $\mu$ F, 10%, 16V, X7R, 0402	C20,C21	Murata Electronics	GRM155R71C104KA88D
CONN, SMA, 4-HOLE PANEL MOUNT JACK	J1, J2	Gigalane Co., Ltd.	PAF-S00-000
IND, 24nH, 5%, W/W, 0603	L1, L6	Coilcraft, Inc.	0603HC-24NXJLW
IND, 8.2nH, 5%, M/L, 0402	L4	Toko Inc.	LL1005-FHL8N2J
IND, 15nH, 5%, M/L, 0402	L5	Toko Inc.	LL1005-FH15NJ
IND, 1.5nH, +/-0.1nH, T/F, 0402	L2	Murata Electronics	LQP15MN1N5B02D
IND, 1.8nH, +/-0.3nH, M/L, 0402	L7	Toko Inc.	LL1005-FH1N8S
CONN, HDR, ST, PLRZD, 5-PIN, 0.100"	P1	ITW Pancon	MPSS100-5-C
CONN, HDR, ST, PLRZD, 6-PIN, 0.100"	P2	ITW Pancon	MPSS100-6-C
RES, 10 $\Omega$ , 5%, 1/16W, 0402	R1	Kamaya, Inc	RMC1/16S-100JTH
RES, 1.3K, 5%, 1/16W, 0402	R3	Panasonic Industrial Sales	ERJ-2GEJ132
RES, 1.2K, 5%, 1/16W, 0402	R4	Kamaya, Inc	RMC1/16S-122JTH
RES, 0 $\Omega$ , 0402	R5	Kamaya, Inc	RMC1/16SJPTH
HEATSINK, BLOCK, TEST FIX, 1.5" x 2.0"		Wells Machining	EEF-101217
SCREW, 2-56 x 3/16", SOCKET HEAD	S1-S9	McMaster-Carr Supply Co.	92196A076

Evaluation Board Assembly Drawing 728MHz to 768MHz Application Circuit

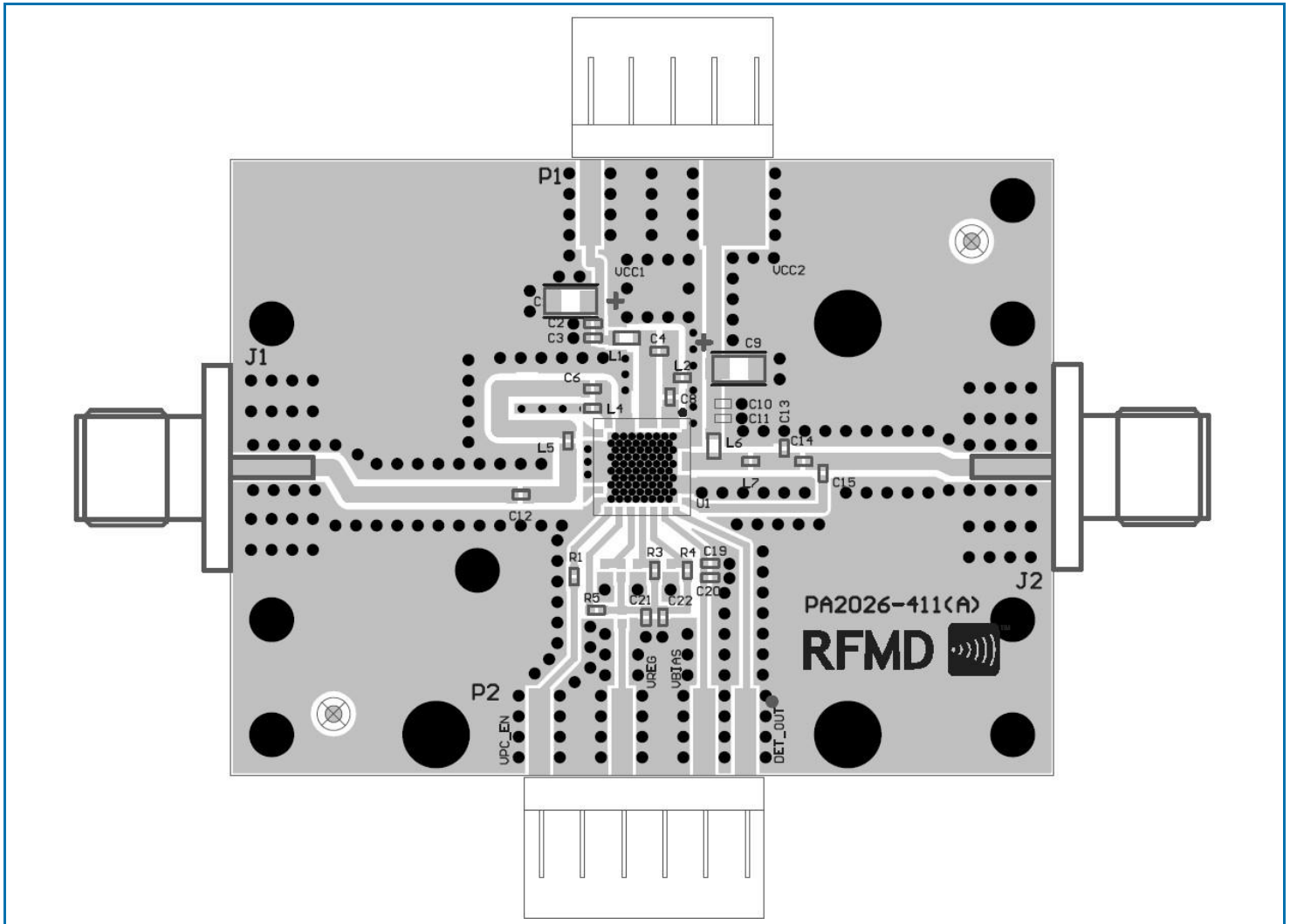

**Typical Performance:  $V_{CC1} = V_{CC2} = V_{CC3} = V_{BIAS} = V_{REG} = 5V$ ,  $V_{PC\_EN} = 1.8V$  2.11GHz to 2.17GHz Application Circuit**

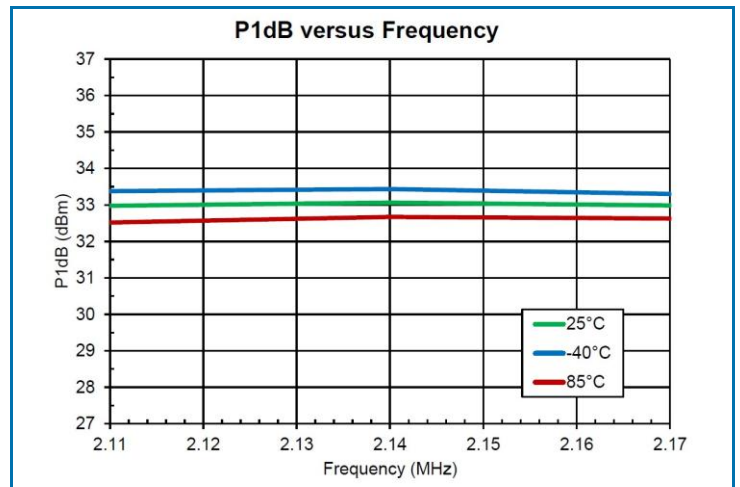
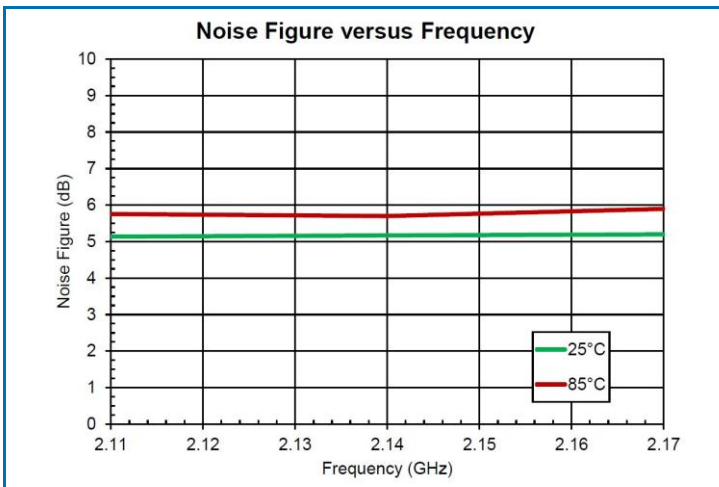
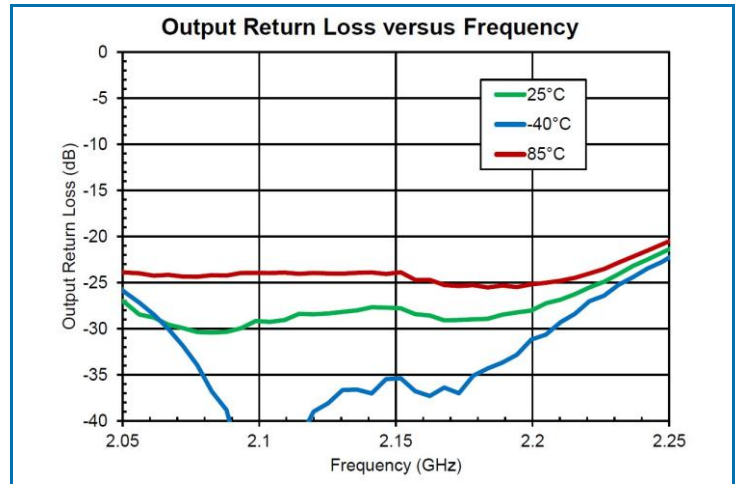
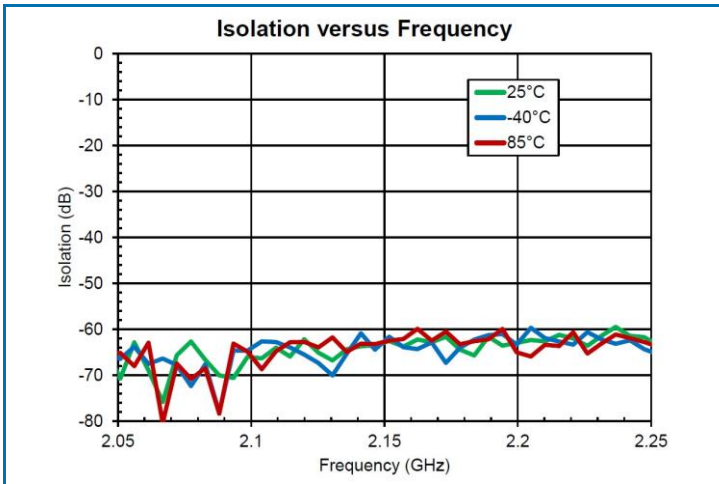
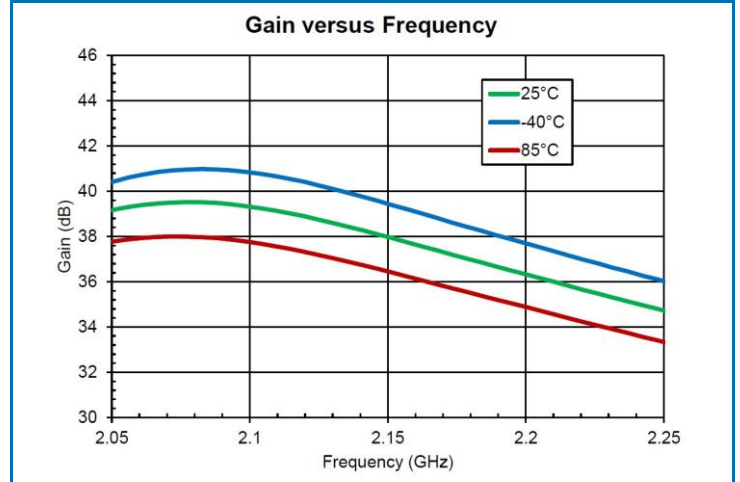
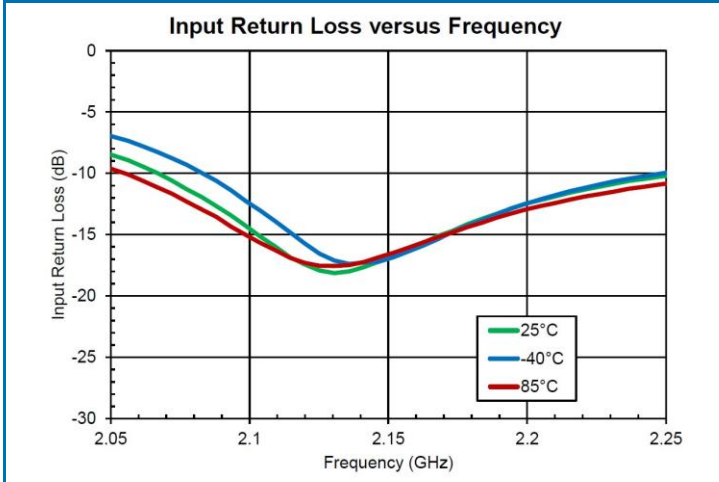

**Typical Performance:  $V_{CC1} = V_{CC2} = V_{CC3} = V_{BIAS} = V_{REG} = 5V$ ,  $V_{PC\_EN} = 1.8V$  2.11GHz to 2.17GHz Application Circuit**

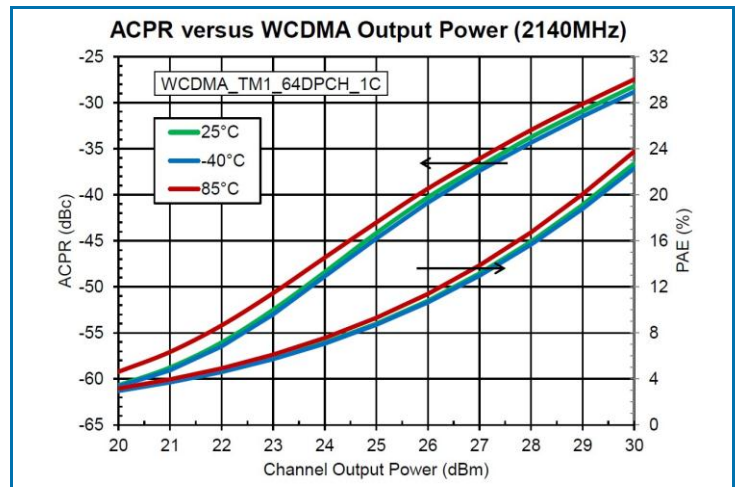
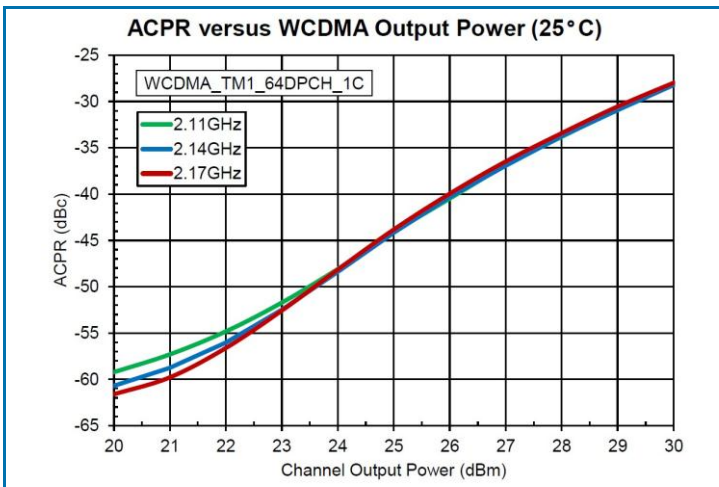
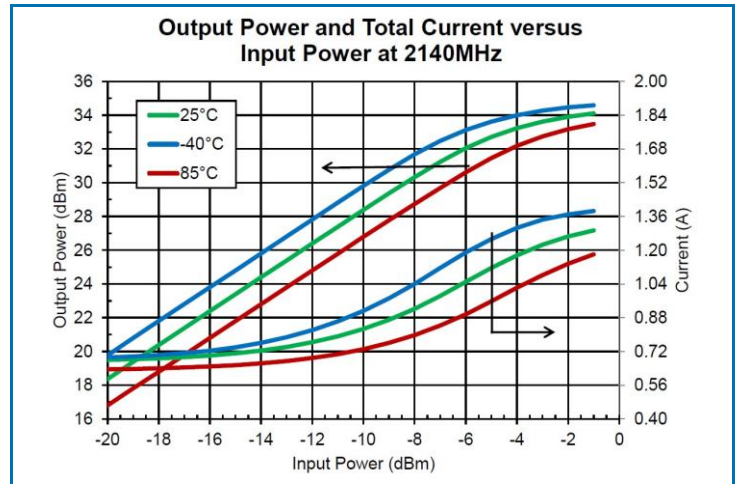
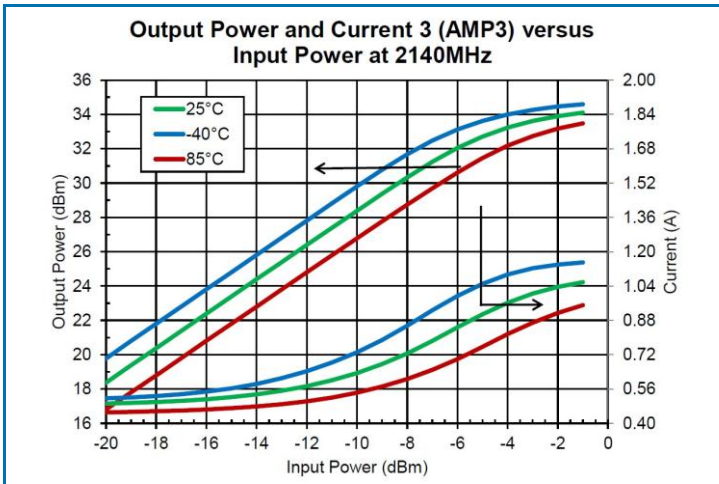
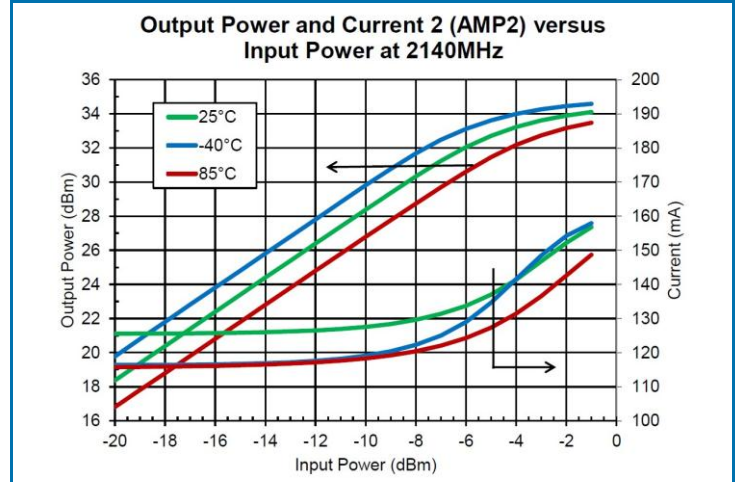
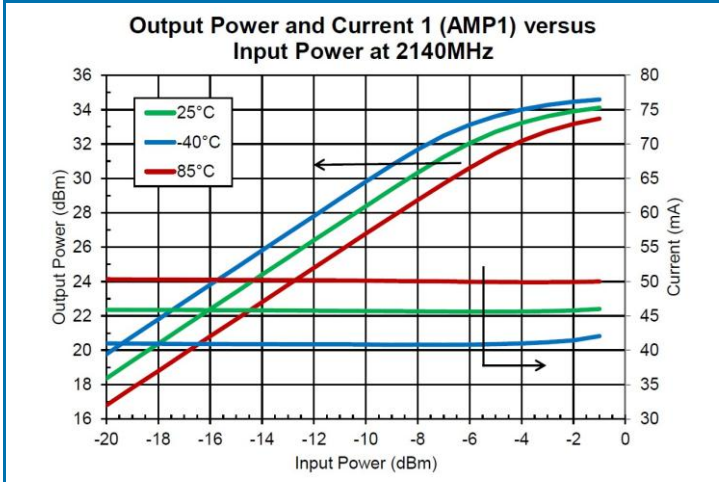

**Typical Performance:  $V_{CC1} = V_{CC2} = V_{CC3} = V_{BIAS} = V_{REG} = 5V$ ,  $V_{PC\_EN} = 1.8V$  2.11GHz to 2.17GHz Application Circuit**

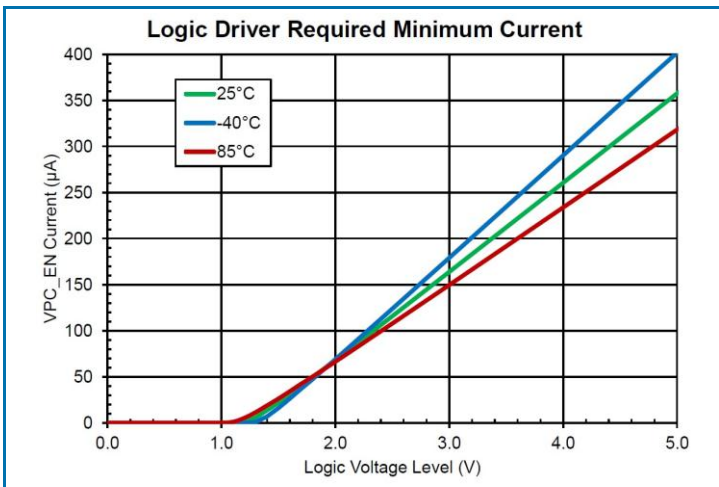
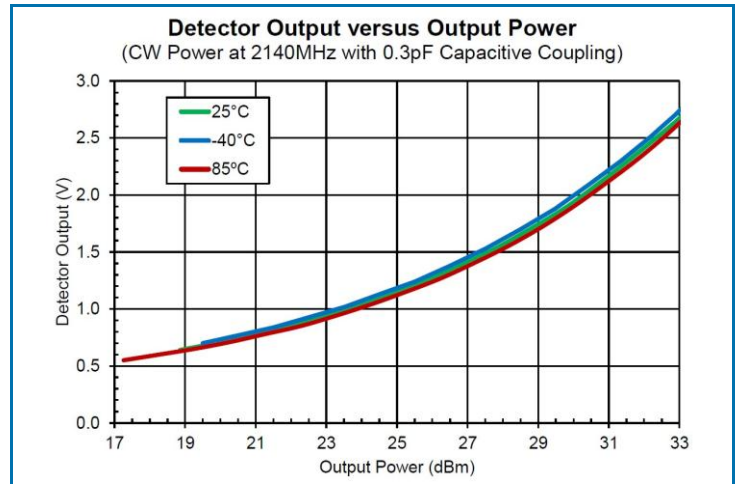
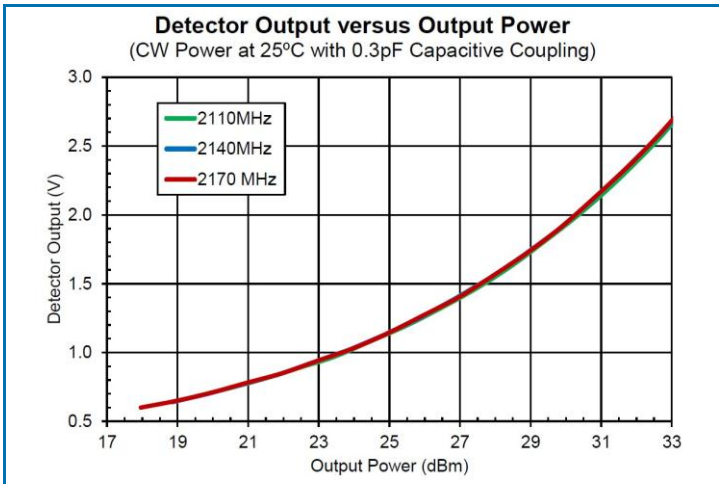
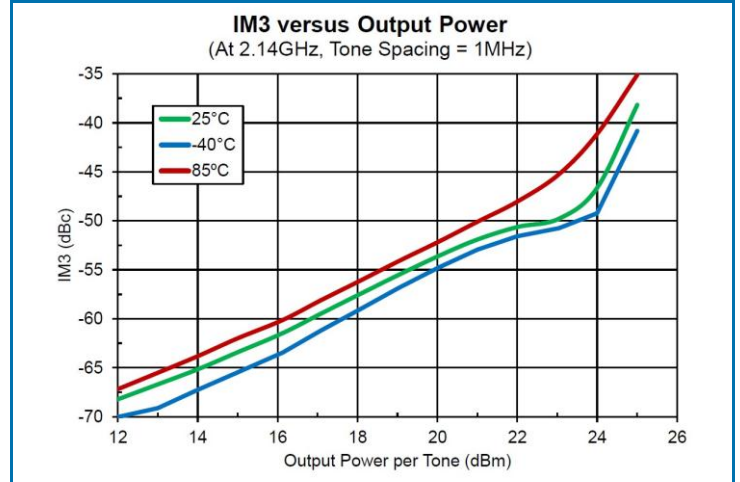
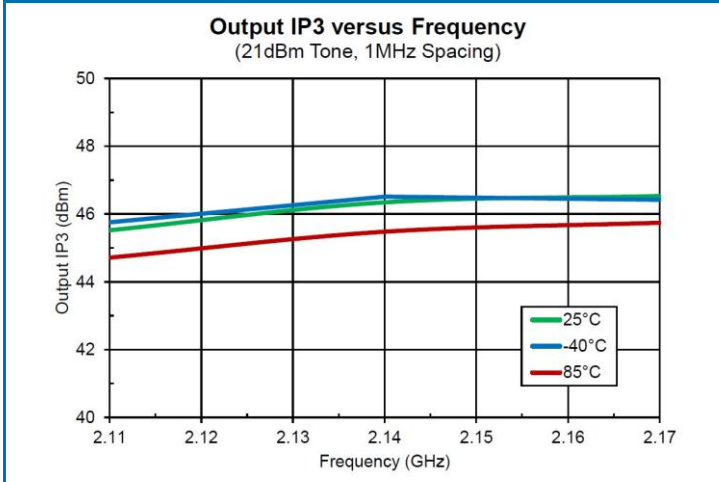

Evaluation Board Schematic 2.11GHz to 2.17GHz Application Circuit

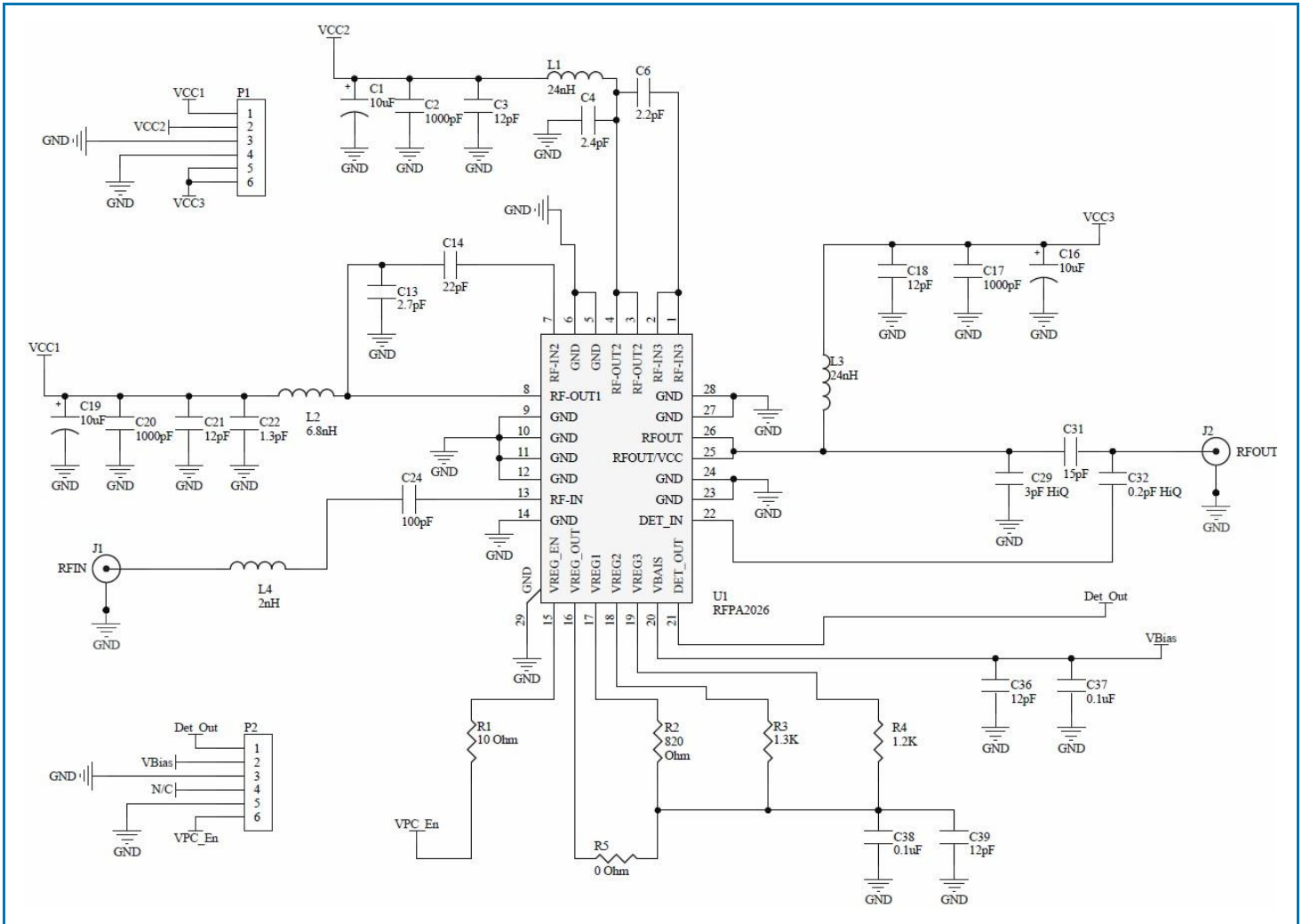

## Evaluation Board Bill of Materials (BOM) 2.11GHz to 2.17GHz Application Circuit

Description	Reference Designator	Manufacturer	Manufacturer's P/N
RFPA2026 Evaluation Board		Dynamic Details (DDI) Toronto	RFPA2026-410(B)
700MHz to 2700MHz PA, 2W, 35dB Gain, Ext. Match	U1	RFMD	RFPA2026
CAP, 10 $\mu$ F, 10%, 10V, TANT-A	C1, C16, C19	AVX Corporation	TAJA106K010RNJ
CAP, 1000pF, 10%, 50V, X7R, 0402	C2, C17, C20	Taiyo Yuden (USA), Inc.	RM UMK105BJ102KV-F
CAP, 12pF, 5%, 50V, C0G, 0402	C3, C18, C21, C36, C39	Murata Electronics	GRM1555C1H120JZ01E
CAP, 2.4pF, +/-0.1pF, 50V, C0G, 0402	C4	Murata Electronics	GRM1555C1H2R4BZ01E
CAP, 2.2pF, +/-0.1pF, 50V, C0G, 0402	C6	Murata Electronics	GRM1555C1H2R2BZ01E
CAP, 2.7pF, +/-0.1pF, 50V, C0G, 0402	C13	Murata Electronics	GRM1555C1H2R7BZ01E
CAP, 22pF, 5%, 50V, CG, 0402	C14	Taiyo Yuden (USA), Inc.	RM UMK105CG220JV-F
1.3pF, .1pF, 25V, COG, 0402, Lead Free, HI-Q	C22	Murata Electronics	GJM1555C1H1R3BB01D
CAP, 100pF, 5%, 50V, C0G, 0402	C24	Murata Electronics	GRM1555C1H101JA01D
CAP, 3pF, +/-0.1pF, 50V, HI-Q, 0402	C29	Johanson Technology	500R07S3R0BV4TD
CAP, 15pF, 5%, 50V, HI-Q, 0402	C31	Murata Electronics	GJM1555C1H150JB01E
CAP, 0.2pF, +/-0.1pF, 50V, HI-Q, 0402	C32	Murata Electronics	GJM1555C1HR20BB01D
CAP, 0.1 $\mu$ F, 10%, 16V, X7R, 0402	C37-C38	Murata Electronics	GRM155R71C104KA88D
CONN, SMA, 4-HOLE PANEL MOUNT JACK	J1-J2	Gigalance Co., Ltd.	PAF-S00-000
IND, 24nH, 5%, W/W, 0603	L1, L3	Coilcraft, Inc.	0603HC-24NXJLW
IND, 6.8nH, 5%, M/L, 0402	L2	Toko Inc.	LL1005-FHL6N8J
IND, 2nH, +/-0.1nH, T/F, 0402	L4	Murata Electronics	LQP15MN2N0B02D
CONN, HDR, ST, PLRZD, 6-PIN, 0.100"	P1-P2	ITW Pancon	MPSS100-6-C
RES, 10 $\Omega$ , 5%, 1/16W, 0402	R1	Kamaya, Inc	RMC1/16S-100JTH
RES, 820 $\Omega$ , 5%, 1/16W, 0402	R2	Kamaya, Inc	RMC1/16S-821JTH
RES, 1.3K, 5%, 1/16W, 0402	R3	Panasonic Industrial Sales	ERJ-2GEJ132
RES, 1.2K, 5%, 1/16W, 0402	R4	Kamaya, Inc	RMC1/16S-122JTH
RES, 0 $\Omega$ , 0402	R5	Kamaya, Inc	RMC1/16SJPTH
HEATSINK, BLOCK, TEST FIX, 1.5" x 2.0"		Wells Machining	EEF-101217
SCREW, 2-56 x 3/16", SOCKET HEAD	S1-S9	McMaster-Carr Supply Co.	92196A076

Evaluation Board Assembly Drawing 2.11GHz to 2.17GHz Application Circuit

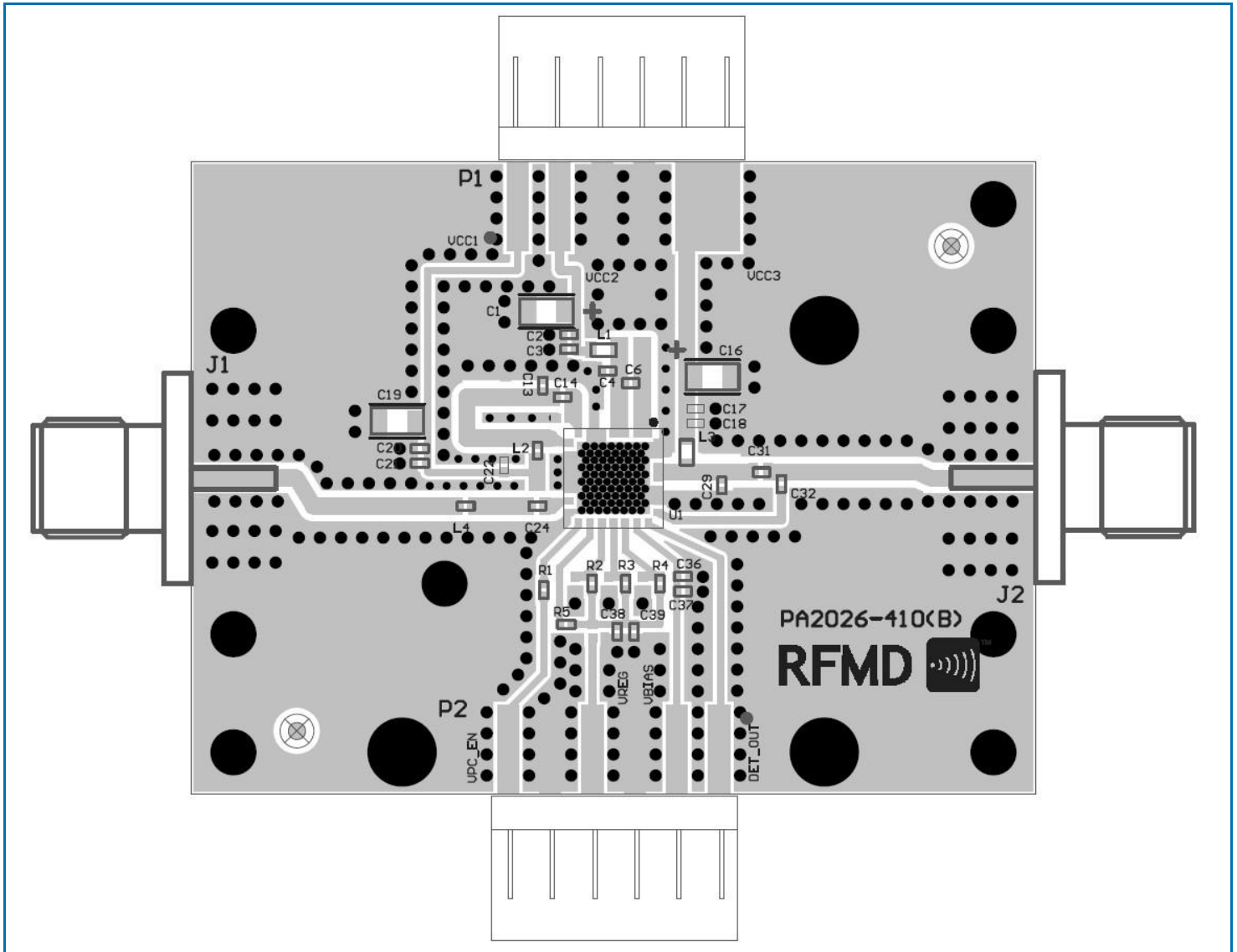



**Typical Performance:  $V_{CC1} = V_{CC2} = V_{CC3} = V_{BIAS} = V_{REG} = 5V$ ,  $V_{PC\_EN} = 1.8V$  2.58GHz to 2.69GHz Application Circuit**

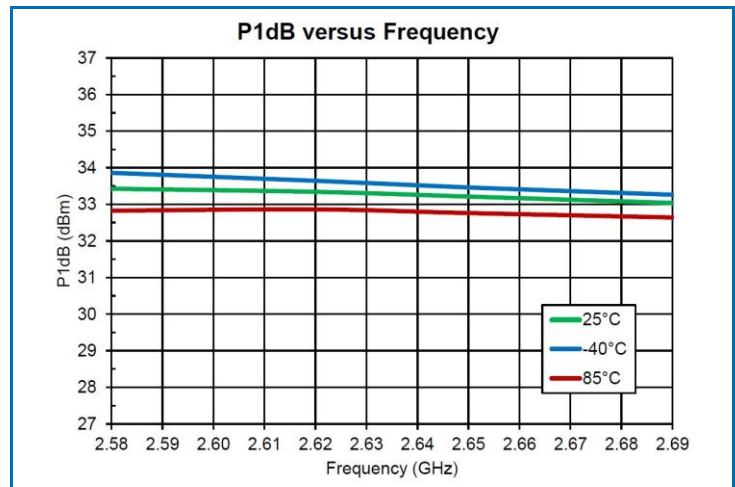
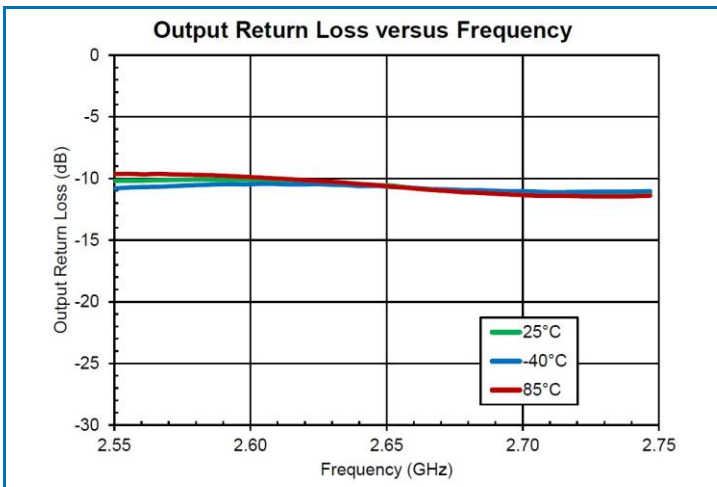
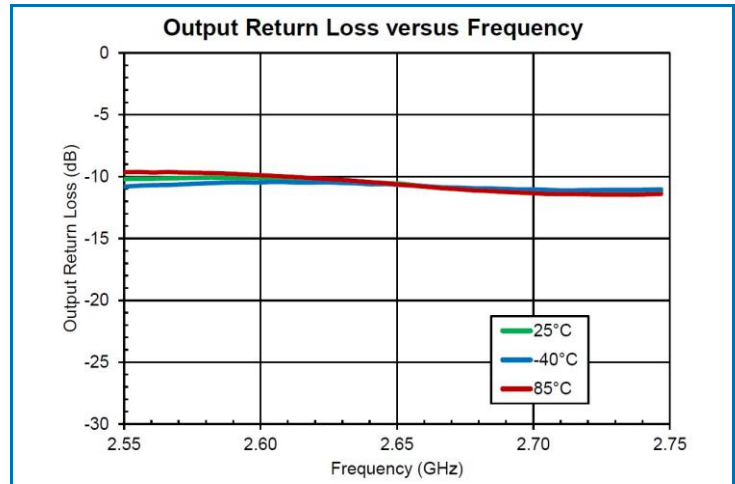
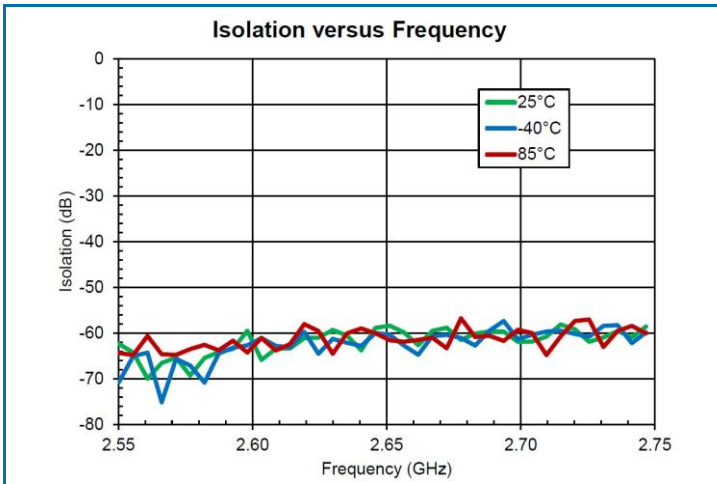
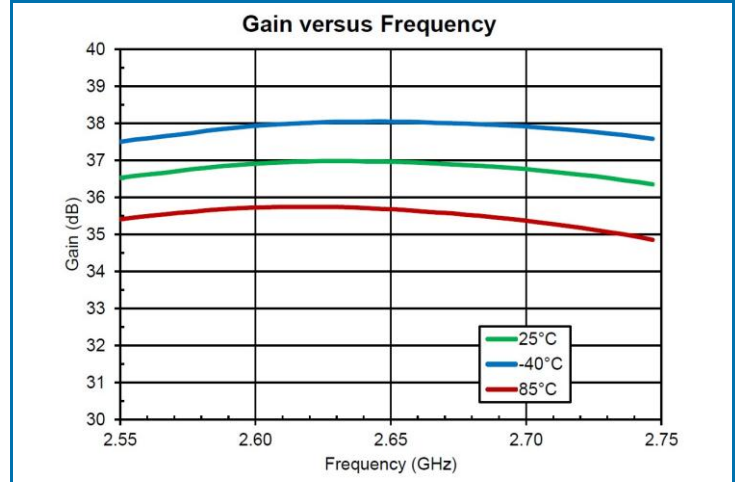
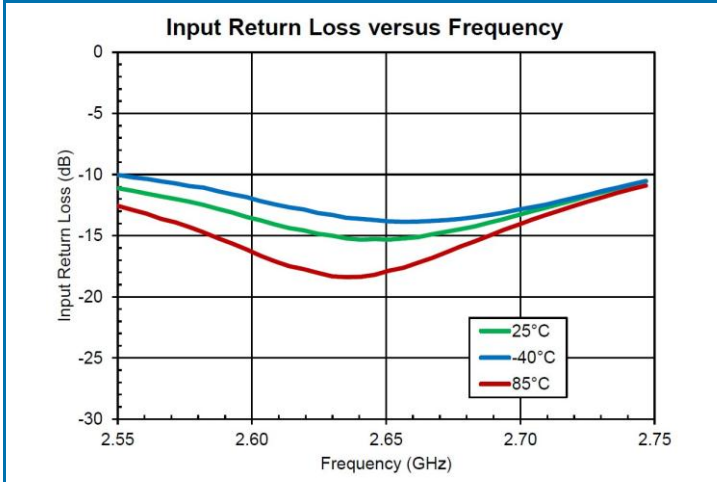

**Typical Performance:  $V_{CC1} = V_{CC2} = V_{CC3} = V_{BIAS} = V_{REG} = 5V$ ,  $V_{PC\_EN} = 1.8V$  2.58GHz to 2.69GHz Application Circuit**

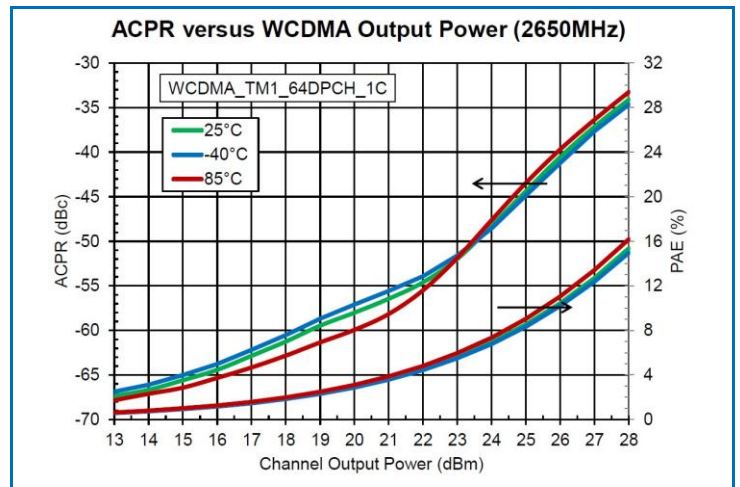
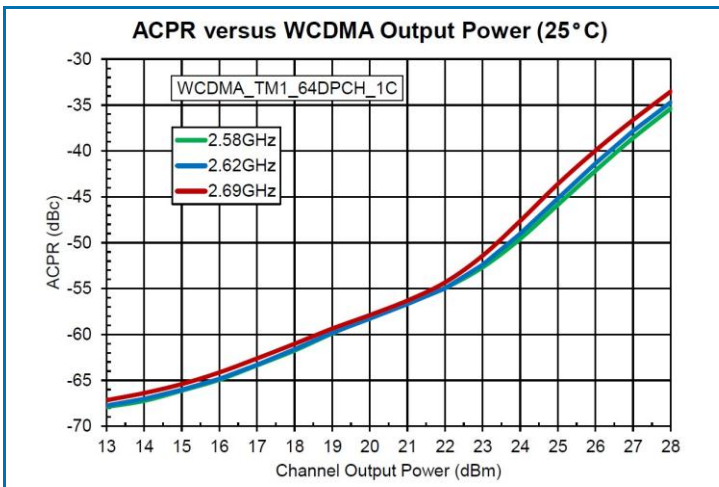
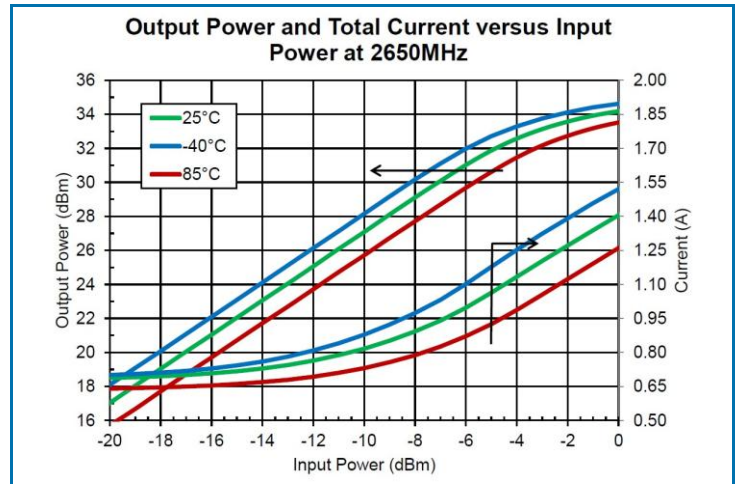
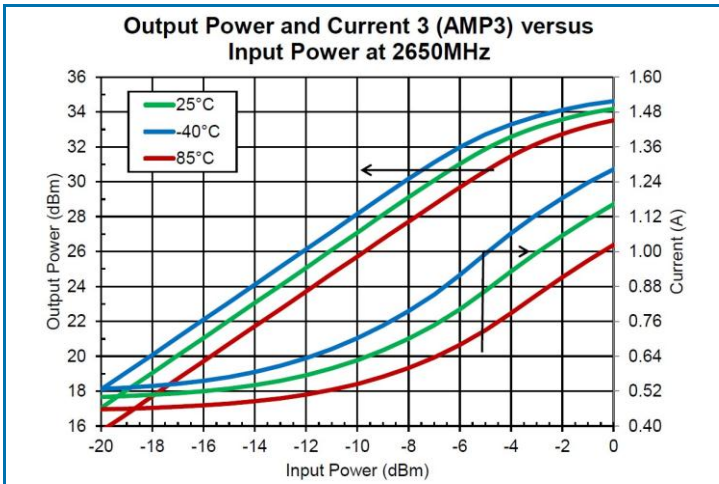
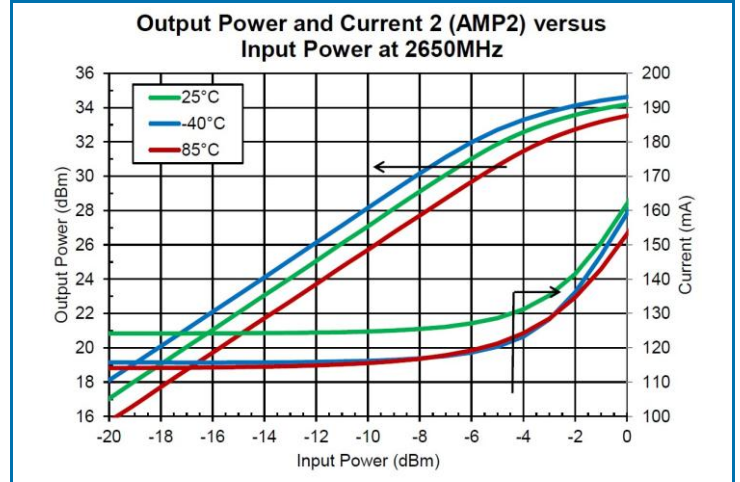
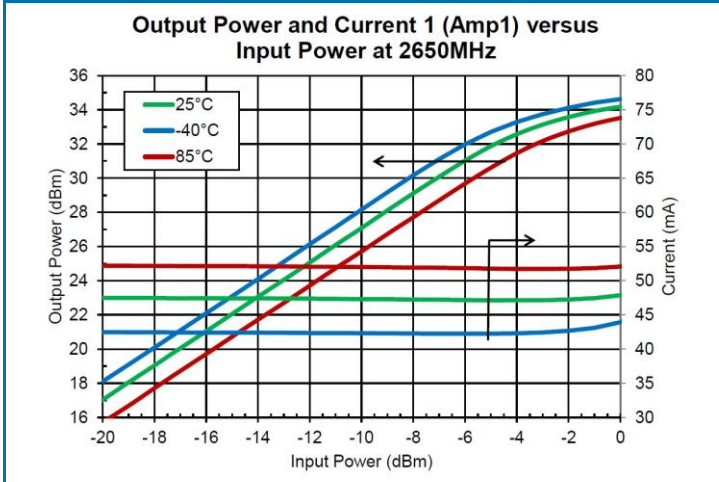

**Typical Performance:  $V_{CC1} = V_{CC2} = V_{CC3} = V_{BIAS} = V_{REG} = 5V$ ,  $V_{PC\_EN} = 1.8V$  2.58GHz to 2.69GHz Application Circuit**

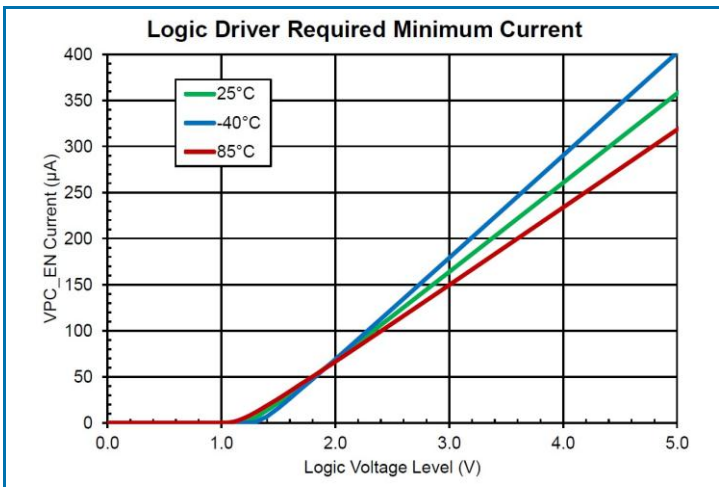
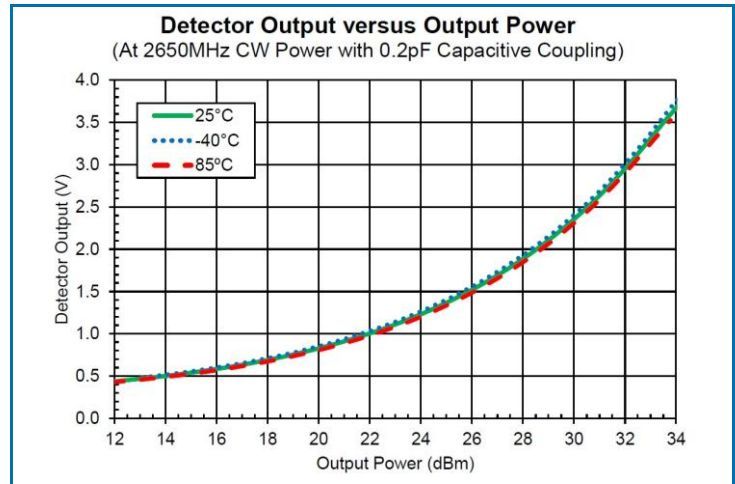
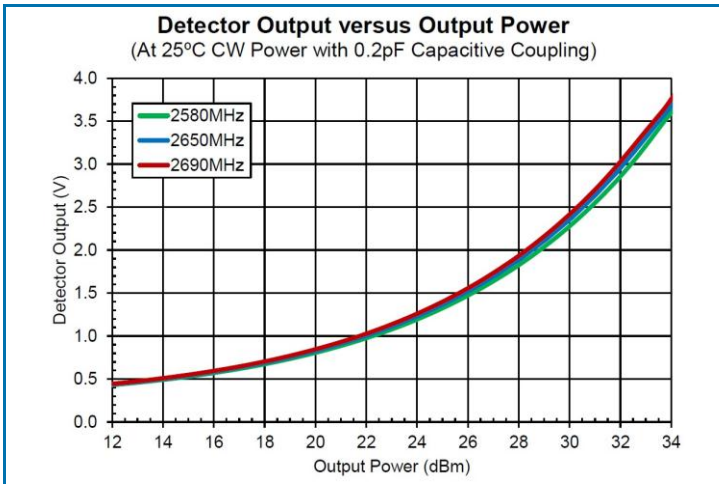
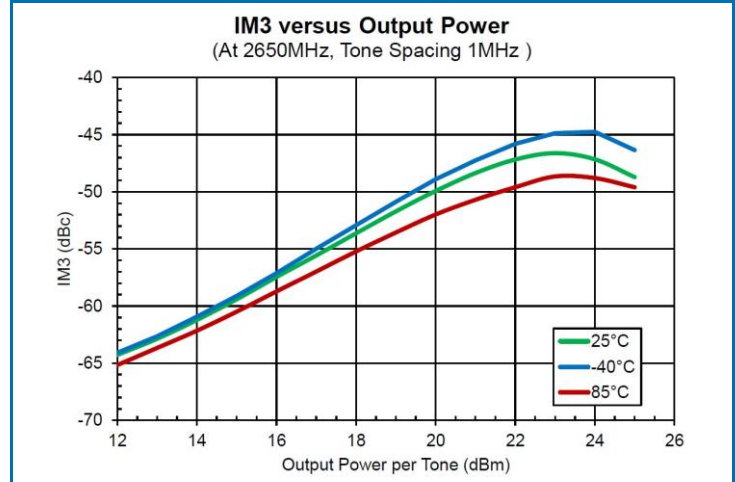
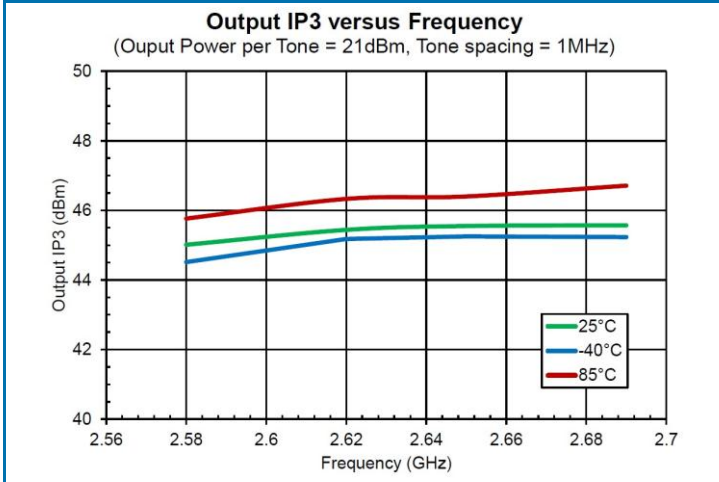

Evaluation Board Schematic 2.58GHz to 2.69GHz Application Circuit

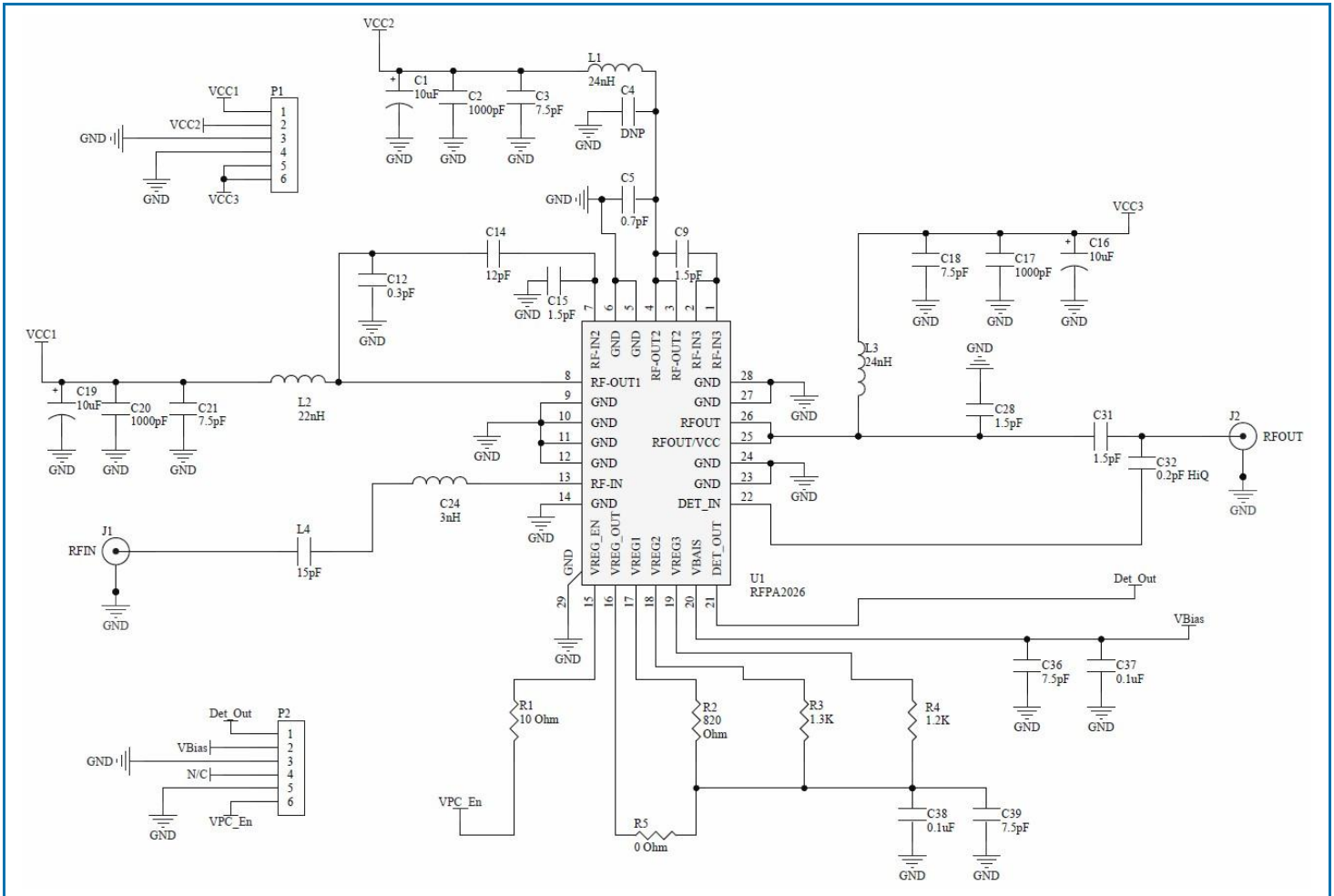

## Evaluation Board Bill of Materials (BOM) 2.58GHz to 2.69GHz Application Circuit

Description	Reference Designator	Manufacturer	Manufacturer's P/N
RFPA2026 Evaluation Board		Dynamic Details (DDI) Toronto	RFPA2026-410(B)
700MHz to 2700MHz PA, 2W, 35dB Gain, Ext. Match	U1	RFMD	RFPA2026
CAP, 10 $\mu$ F, 10%, 10V, TANT-A	C1, C16, C19	AVX Corporation	TAJA106K010RNJ
CAP, 1000pF, 10%, 50V, X7R, 0402	C2, C17, C20	Taiyo Yuden (USA), Inc.	RM UMK105BJ102KV-F
CAP, 7.5pF, +/-0.5pF, 50V, C0G, 0402	C3, C18, C21, C36, C39	Murata Electronics	GRM1555C1H7R5DZ01E
CAP, 0.7pF, +/-0.1pF, 50V, C0G, 0402	C5	Murata Electronics	GRM1555C1HR70BZ01D
CAP, 1.5pF, +/-0.1pF, 50V, C0G, 0402	C9, C15	Murata Electronics	GRM1555C1H1R5BZ01E
CAP, 0.3pF, +/-0.05pF, 50V, HI-Q, 0402	C12	Murata Electronics	GJM1555C1HR30WB01D
CAP, 12pF, 5%, 50V, C0G, 0402	C14	Murata Electronics	GRM1555C1H120JZ01E
IND, 3nH, +/-0.1nH, T/F, 0402	C24	Murata Electronics	LQP15MN3N0B02D
CAP, 1.5pF, +/-0.1pF, 200V, HI-Q, 0402	C28, C31	American Technical Ceramics	600L1R5BT200T
CAP, 0.2pF, +/-0.1pF, 50V, HI-Q, 0402	C32	Murata Electronics	GJM1555C1HR20BB01D
CAP, 0.1 $\mu$ F, 10%, 16V, X7R, 0402	C37-C38	Murata Electronics	GRM155R71C104KA88D
CONN, SMA, 4-HOLE PANEL MOUNT JACK	J1-J2	Gigalance Co., Ltd.	PAF-S00-000
IND, 24nH, 5%, W/W, 0603	L1, L3	Coilcraft, Inc.	0603HC-24NXJLW
IND, 22nH, 5%, M/L, 0402	L2	Toko Inc.	LL1005-FH22NJ
CAP, 15pF, 5%, 50V, HI-Q, 0402	L4	Murata Electronics	GJM1555C1H150JB01E
CONN, HDR, ST, PLRZD, 6-PIN, 0.100"	P1-P2	ITW Pancon	MPSS100-6-C
RES, 10 $\Omega$ , 5%, 1/16W, 0402	R1	Kamaya, Inc	RMC1/16S-100JTH
RES, 820 $\Omega$ , 5%, 1/16W, 0402	R2	Kamaya, Inc	RMC1/16S-821JTH
RES, 1.3K, 5%, 1/16W, 0402	R3	Panasonic Industrial Sales	ERJ-2GEJ132
RES, 1.2K, 5%, 1/16W, 0402	R4	Kamaya, Inc	RMC1/16S-122JTH
RES, 0 $\Omega$ , 0402	R5	Kamaya, Inc	RMC1/16SJPTH
HEATSINK, BLOCK, TEST FIX, 1.5" x 2.0"		Wells Machining	EEF-101217
SCREW, 2-56 x 3/16", SOCKET HEAD	S1-S9	McMaster-Carr Supply Co.	92196A076

Evaluation Board Assembly Drawing 2.58GHz to 2.69GHz Application Circuit

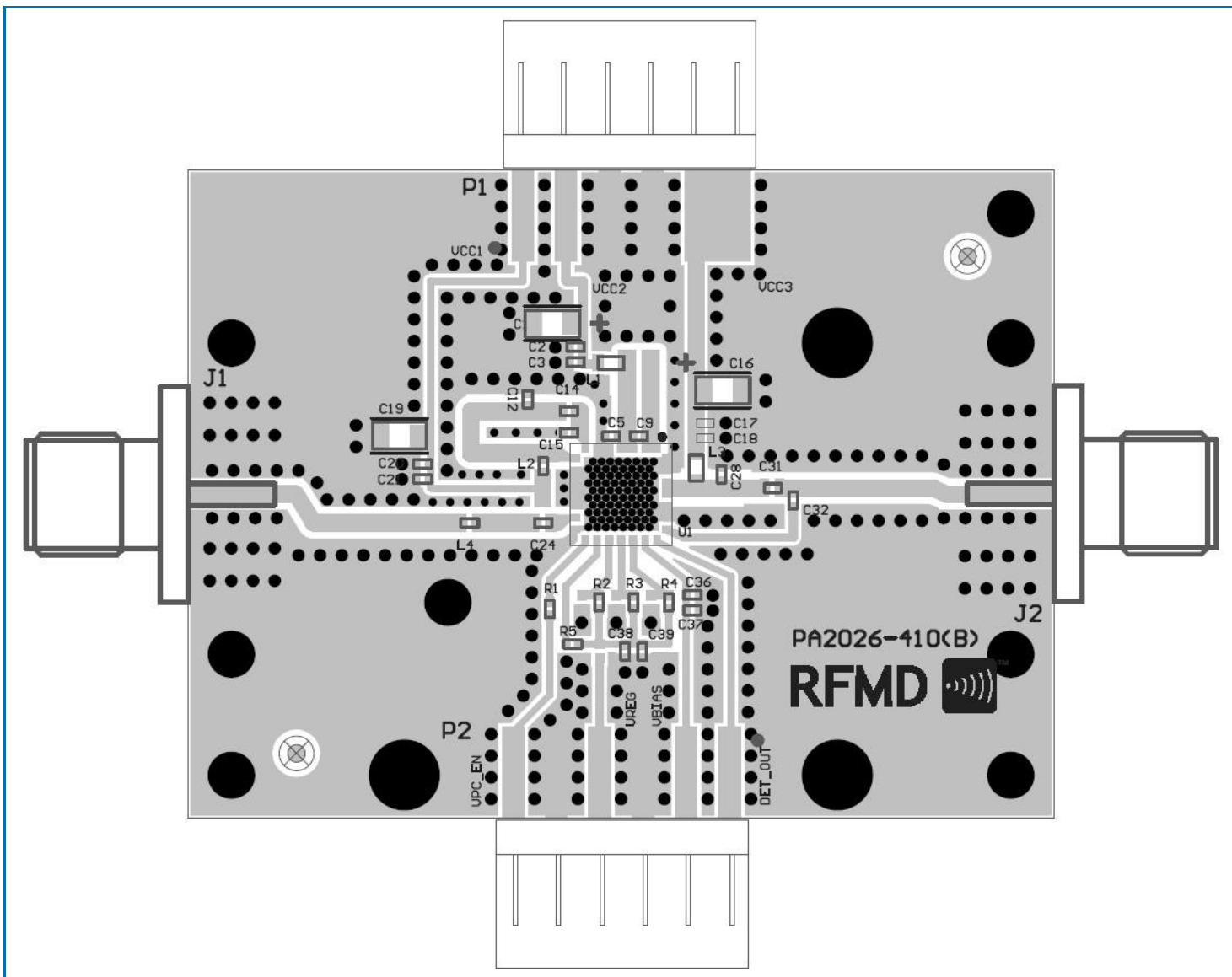

## Pin Names and Descriptions

Pin	Name	Description
1	RFIN3	RF Input for stage 3, must be DC blocked
2	RFIN3	RF Input for stage 3, must be DC blocked
3	RFOUT2/VCC2	RF Output and collector supply for stage 2
4	RFOUT2/VCC2	RF Output and collector supply for stage 2
5	GND	Ground
6	GND	Ground
7	RFIN2	RF Input for stage 2, must be DC blocked
8	RFIYT1/VCC1	RF Output and collector supply for stage 1
9	GND	Ground
10	GND	Ground
11	GND	Ground
12	GND	Ground
13	RFIN1	RF Input for stage 1, must be DC blocked
14	GND	Ground
15	VPC_EN	V <sub>PC</sub> Enable (low = shutdown)
16	VPC-OUT	V <sub>PC</sub> Output to amplifier V <sub>REG</sub> resistors
17	VREG1	Stage 1 V <sub>REG</sub>
18	VREG2	Stage 2 V <sub>REG</sub>
19	VREG3	Stage 3 V <sub>REG</sub>
20	VBIAS	V <sub>CC</sub> Supply to detector, V <sub>PC</sub> switch, and amplifier V <sub>BIAS</sub> pins
21	DET_OUT	Detector Output Voltage
22	DET_IN	RF Input to Detector
23	GND	Ground
24	GND	Ground
25	RFOUT3/VCC3	RF Output and collector supply for stage 3
26	RFOUT3/VCC3	RF Output and collector supply for stage 3
27	GND	Ground
28	GND	Ground

Package Outline (Dimensions in millimeters)

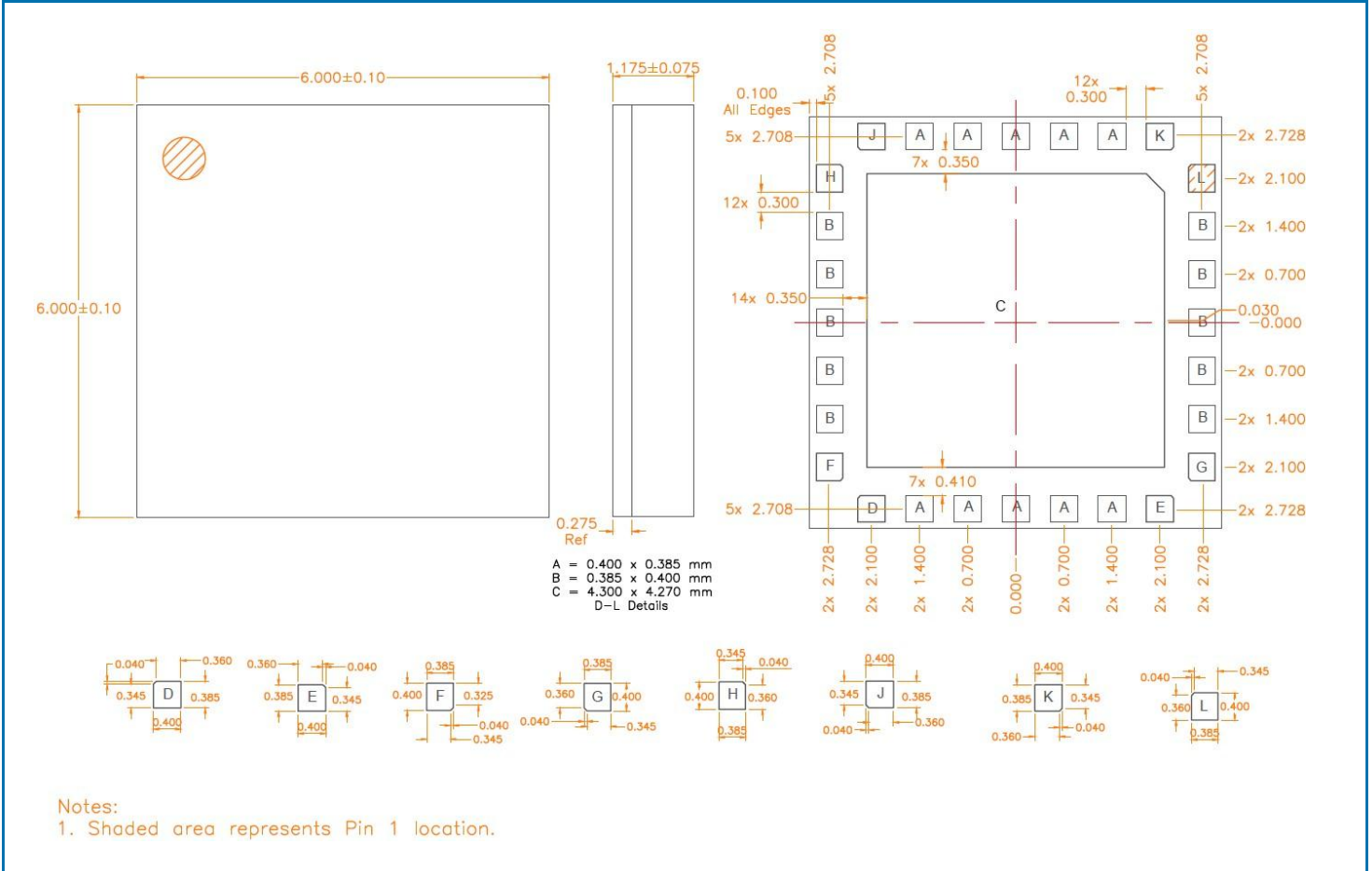



**Branding Diagram**

