

Power Splitter/Combiner

SCQ-4-1650+

4 Way Quadrifilar 50Ω 1150 to 1650 MHz



CASE STYLE: HU1374

Maximum Ratings

Operating Temperature	-40°C to 85°C
Storage Temperature	-55°C to 100°C
Power Input (as a splitter)	1W max.
Internal Dissipation	0.20W max.

Permanent damage may occur if any of these limits are exceeded.

Pin Connections

SUM PORT	11
PORT 1 (0°)	9
PORT 2 (90°)	6
PORT 3 (180°)	2
PORT 4 (270°)	13
GROUND	1,3,4,5,7,8,10,12,14

Features

- good isolation, 22 dB typ.
- good phase unbalance, 1 deg.
- good matching VSWR, 1.15:1 typ.

Applications

- GPS phase array antenna

+RoHS Compliant
The +Suffix identifies RoHS Compliance. See our web site for RoHS Compliance methodologies and qualifications

Electrical Specifications

FREQ. RANGE (MHz)	ISOLATION (dB)		INSERTION LOSS (dB) ABOVE 6dB		PHASE* UNBALANCE (Degrees)		AMPLITUDE UNBALANCE (dB)		VSWR (:1)	
	Typ.	Min.	Typ.	Max.	Typ.	Max.	Max.	S Typ.	OUT Typ.	
f _L -f _U										
1150-1650	22	18	1.5	2.0	3.0	8.0	1.0	1.2	1.1	

*Phase Unbalance is referenced insertion phase at 0° port.

Typical Performance Data

Freq. (MHz)	Total Loss ¹ (dB)	Amp. Unbal. (dB)	Insertion Phase (deg)	Phase Unbalance (deg.)				Isolation (dB)			VSWR S	VSWR 1	VSWR 2	VSWR 3	VSWR 4
				0°	90°	180°	270°	1-2	2-3	3-4					
1150.00	6.98	0.32	160.79	0.00	88.03	179.66	267.65	22.35	31.34	25.42	1.09	1.03	1.04	1.07	1.02
1200.00	7.10	0.18	144.77	0.00	88.25	179.80	267.68	22.07	30.71	25.20	1.10	1.03	1.06	1.07	1.02
1225.00	7.16	0.26	136.76	0.00	88.37	179.89	267.72	21.94	30.39	25.11	1.11	1.03	1.06	1.07	1.03
1250.00	7.21	0.33	128.75	0.00	88.49	179.96	267.76	21.82	30.06	25.02	1.11	1.03	1.07	1.07	1.03
1275.00	7.26	0.38	120.75	0.00	88.62	180.02	267.82	21.72	29.69	24.95	1.11	1.03	1.07	1.08	1.04
1300.00	7.31	0.43	112.75	0.00	88.76	180.07	267.88	21.65	29.32	24.90	1.11	1.04	1.08	1.08	1.04
1350.00	7.38	0.51	96.73	0.00	89.04	180.18	268.04	21.54	28.55	24.88	1.11	1.04	1.09	1.09	1.05
1400.00	7.44	0.54	80.72	0.00	89.32	180.28	268.21	21.52	27.81	24.98	1.12	1.05	1.10	1.10	1.06
1450.00	7.48	0.54	64.73	0.00	89.60	180.32	268.38	21.59	27.08	25.19	1.12	1.06	1.10	1.11	1.07
1500.00	7.50	0.53	48.73	0.00	89.83	180.35	268.57	21.73	26.33	25.50	1.14	1.06	1.11	1.12	1.07
1525.00	7.50	0.51	40.73	0.00	89.96	180.35	268.67	21.83	26.00	25.70	1.15	1.07	1.11	1.13	1.08
1550.00	7.50	0.48	32.73	0.00	90.07	180.33	268.76	21.94	25.67	25.91	1.16	1.07	1.11	1.13	1.08
1575.00	7.49	0.44	24.73	0.00	90.18	180.30	268.87	22.07	25.33	26.16	1.18	1.07	1.11	1.14	1.08
1600.00	7.48	0.39	16.75	0.00	90.28	180.25	268.98	22.23	25.02	26.43	1.20	1.08	1.11	1.14	1.09
1650.00	7.46	0.30	0.72	0.00	90.48	180.20	269.22	22.57	24.40	26.99	1.23	1.08	1.11	1.14	1.10

1. Total Loss = Insertion Loss + 6dB splitter loss.

Outline Drawing

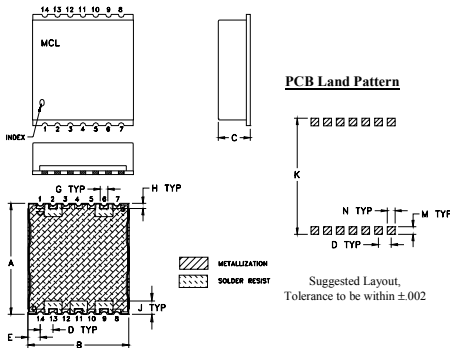

Outline Dimensions (inch/mm)

A	B	C	D	E	F	G	H
.870	.800	.250	.100	.097	--	.060	.040
22.10	20.32	6.35	2.54	2.46	--	1.52	1.02
J	K	L	M	N	P	wt	
.105	.910	--	.060	.060	--	grams	
2.67	23.11	--	1.52	1.52	--	2.85	

Demo Board MCL P/N: TB-490+ Suggested PCB Layout (PL-292)

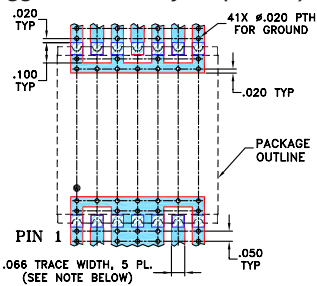

- NOTES: 1. TRACE WIDTH IS SHOWN FOR ROGERS RO4350B WITH DIELECTRIC THICKNESS .030" ± .002"; COPPER: 1/2 OZ. EACH SIDE. FOR OTHER MATERIALS TRACE WIDTH MAY NEED TO BE MODIFIED.
2. BOTTOM SIDE OF THE PCB IS CONTINUOUS GROUND PLANE.
- DENOTES PCB COPPER LAYOUT WITH SMOBC (SOLDER MASK OVER BARE COPPER)
 - DENOTES COPPER LAND PATTERN FREE OF SOLDER MASK

Electrical Configuration

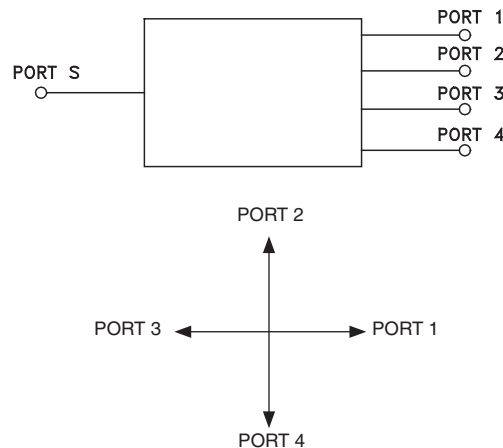

Notes

- A. Performance and quality attributes and conditions not expressly stated in this specification document are intended to be excluded and do not form a part of this specification document.
B. Electrical specifications and performance data contained in this specification document are based on Mini-Circuit's applicable established test performance criteria and measurement instructions.
C. The parts covered by this specification document are subject to Mini-Circuit's standard limited warranty and terms and conditions (collectively, "Standard Terms"); Purchasers of this part are entitled to the rights and benefits contained therein. For a full statement of the Standard Terms and the exclusive rights and remedies thereunder, please visit Mini-Circuit's website at www.minicircuits.com/MCLStore/terms.jsp



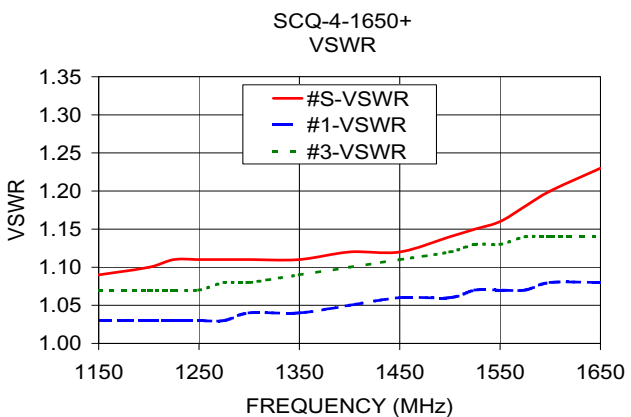
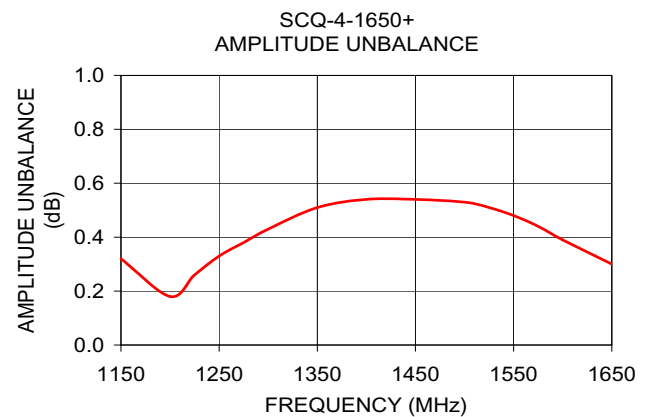
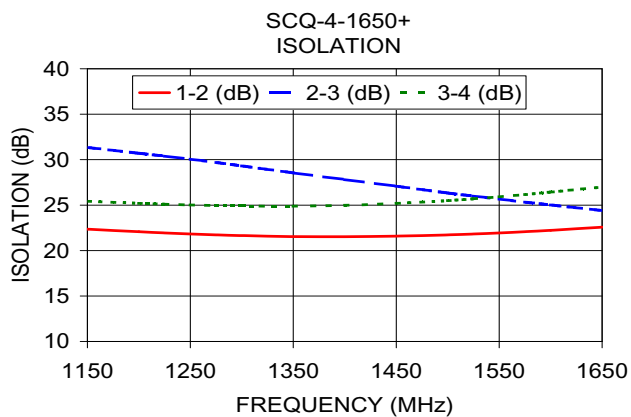
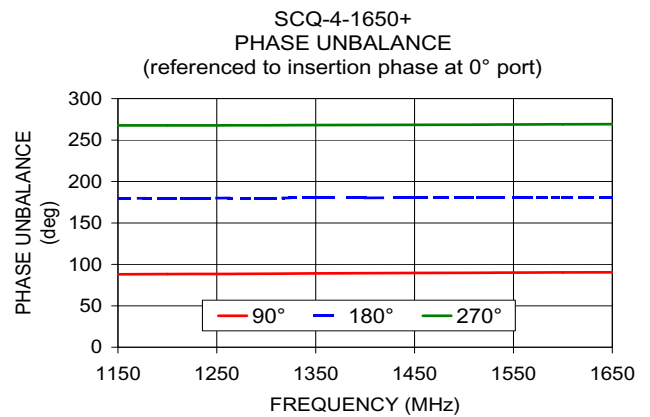
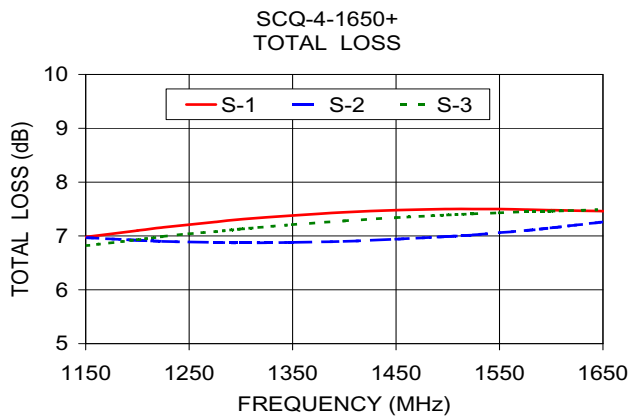

Notes

- A. Performance and quality attributes and conditions not expressly stated in this specification document are intended to be excluded and do not form a part of this specification document.
- B. Electrical specifications and performance data contained in this specification document are based on Mini-Circuit's applicable established test performance criteria and measurement instructions.
- C. The parts covered by this specification document are subject to Mini-Circuits standard limited warranty and terms and conditions (collectively, "Standard Terms"); Purchasers of this part are entitled to the rights and benefits contained therein. For a full statement of the Standard Terms and the exclusive rights and remedies thereunder, please visit Mini-Circuits' website at www.minicircuits.com/MCLStore/terms.jsp

