

Absolute Maximum Ratings		Values		Units
Symbol	Conditions <sup>1)</sup>			
V <sub>CES</sub>		1200		V
V <sub>CGR</sub>	R <sub>GE</sub> = 20 kΩ	1200		V
I <sub>C</sub>	T <sub>case</sub> = 25/80 °C	100 / 90		A
I <sub>CM</sub>	T <sub>case</sub> = 25/80 °C; t <sub>p</sub> = 1 ms	200 / 180		A
V <sub>GES</sub>		± 20		V
P <sub>tot</sub>	per IGBT, T <sub>case</sub> = 25 °C	690		W
T <sub>j</sub> , (T <sub>stg</sub> )		- 40 ... +150 (125)		°C
V <sub>isol</sub>	AC, 1 min.	2 500 <sup>7)</sup>		V
humidity	DIN 40 040	Class F		
climate	DIN IEC 68 T.1	40/125/56		

Inverse Diode		FWD <sup>6)</sup>		Units
I <sub>F</sub> = - I <sub>C</sub>	T <sub>case</sub> = 25/80 °C	95 / 65	130 / 90	A
I <sub>FM</sub> = - I <sub>CM</sub>	T <sub>case</sub> = 25/80 °C; t <sub>p</sub> = 1 ms	200 / 180	200 / 180	A
I <sub>FSM</sub>	t <sub>p</sub> = 10 ms; sin.; T <sub>j</sub> = 150 °C	720	1100	A
I <sub>t</sub> <sup>2</sup>	t <sub>p</sub> = 10 ms; T <sub>j</sub> = 150 °C	2600	6000	A <sup>2</sup> s

Characteristics		min.	typ.	max.	Units
Symbol	Conditions <sup>1)</sup>				
V <sub>(BR)CES</sub>	V <sub>GE</sub> = 0, I <sub>C</sub> = 4 mA	≥ V <sub>CES</sub>	-	-	V
V <sub>GE(th)</sub>	V <sub>GE</sub> = V <sub>CE</sub> , I <sub>C</sub> = 2 mA	4,5	5,5	6,5	V
I <sub>CES</sub>	V <sub>GE</sub> = 0 } T <sub>j</sub> = 25 °C	-	0,1	1,5	mA
		V <sub>CE</sub> = V <sub>CES</sub> } T <sub>j</sub> = 125 °C	-	6	-
I <sub>GES</sub>	V <sub>GE</sub> = 20 V, V <sub>CE</sub> = 0	-	-	300	nA
V <sub>CEsat</sub>	I <sub>C</sub> = 75 A } V <sub>GE</sub> = 15 V;	-	2,5(3,1)	3(3,7)	V
V <sub>CEsat</sub>	I <sub>C</sub> = 100 A } T <sub>j</sub> = 25 (125) °C	-	2,8(3,6)	-	V
g <sub>fs</sub>	V <sub>CE</sub> = 20 V, I <sub>C</sub> = 75 A	31	-	-	S
C <sub>CHC</sub>	per IGBT	-	-	350	pF
C <sub>ies</sub>	V <sub>GE</sub> = 0 } V <sub>CE</sub> = 25 V } f = 1 MHz	-	5	6,6	nF
C <sub>oes</sub>		-	720	900	pF
C <sub>res</sub>		-	380	500	pF
L <sub>CE</sub>		-	-	30	nH
t <sub>d(on)</sub>	V <sub>CC</sub> = 600 V } V <sub>GE</sub> = +15 V, - 15 V <sup>3)</sup> } I <sub>C</sub> = 75 A, ind. load } R <sub>Gon</sub> = R <sub>Goff</sub> = 15 Ω } T <sub>j</sub> = 125 °C	-	30	60	ns
t <sub>r</sub>		-	70	140	ns
t <sub>d(off)</sub>		-	450	600	ns
t <sub>f</sub>		-	70	90	ns
E <sub>on</sub> <sup>5)</sup>		-	10	-	mWs
E <sub>off</sub> <sup>5)</sup>		-	8	-	mWs

Inverse Diode <sup>8)</sup>				Units	
V <sub>F</sub> = V <sub>EC</sub>	I <sub>F</sub> = 75 A } V <sub>GE</sub> = 0 V;	-	2,0(1,8)	2,5	V
V <sub>F</sub> = V <sub>EC</sub>	I <sub>F</sub> = 100 A } T <sub>j</sub> = 25 (125) °C	-	2,25(2,05)	-	V
V <sub>TO</sub>	T <sub>j</sub> = 125 °C	-	-	1,2	V
r <sub>T</sub>	T <sub>j</sub> = 125 °C	-	12	15	mΩ
I <sub>R</sub> RM	I <sub>F</sub> = 75 A; T <sub>j</sub> = 25 (125) °C <sup>2)</sup>	-	27(40)	-	A
Q <sub>rr</sub>	I <sub>F</sub> = 75 A; T <sub>j</sub> = 25 (125) °C <sup>2)</sup>	-	3(10)	-	μC

FWD of types "GAL", "GAR" <sup>8)</sup>				Units	
V <sub>F</sub> = V <sub>EC</sub>	I <sub>F</sub> = 75 A } V <sub>GE</sub> = 0 V;	-	1,85(1,6)	2,2	V
V <sub>F</sub> = V <sub>EC</sub>	I <sub>F</sub> = 100 A } T <sub>j</sub> = 25 (125) °C	-	2,0(1,8)	-	V
V <sub>TO</sub>	T <sub>j</sub> = 125 °C	-	-	1,2	V
r <sub>T</sub>	T <sub>j</sub> = 125 °C	-	9	11	mΩ
I <sub>R</sub> RM	I <sub>F</sub> = 75 A; T <sub>j</sub> = 25 (125) °C <sup>2)</sup>	-	30(45)	-	A
Q <sub>rr</sub>	I <sub>F</sub> = 75 A; T <sub>j</sub> = 25 (125) °C <sup>2)</sup>	-	3,5(11)	-	μC

Thermal Characteristics				Units	
R <sub>thjc</sub>	per IGBT	-	-	0,18	°C/W
R <sub>thjc</sub>	per diode / FWD "GAL; GAR"	-	-	0,50/0,36	°C/W
R <sub>thch</sub>	per module	-	-	0,05	°C/W

## SEMITRANS® M IGBT Modules

**SKM 100 GB 123 D**  
**SKM 100 GAL 123 D <sup>6)</sup>**  
**SKM 100 GAR 123 D <sup>6)</sup>**



## SEMITRANS 2

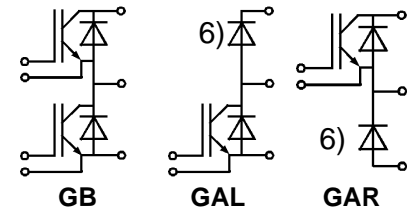

### Features

- MOS input (voltage controlled)
- N channel, Homogeneous Si
- Low inductance case
- Very low tail current with low temperature dependence
- High short circuit capability, self limiting to 6 \* I<sub>Cnom</sub>
- Latch-up free
- Fast & soft inverse CAL diodes<sup>8)</sup>
- Isolated copper baseplate using DCB Direct Copper Bonding Technology
- Large clearance (10 mm) and creepage distances (20 mm).

### Typical Applications: → B 6 -115

- Switching (not for linear use)

<sup>1)</sup> T<sub>case</sub> = 25 °C, unless otherwise specified

<sup>2)</sup> I<sub>F</sub> = - I<sub>C</sub>, V<sub>R</sub> = 600 V, - di<sub>F</sub>/dt = 800 A/μs, V<sub>GE</sub> = 0 V

<sup>3)</sup> Use V<sub>GEoff</sub> = -5 ... -15 V

<sup>5)</sup> See fig. 2 + 3; R<sub>Goff</sub> = 15 Ω

<sup>6)</sup> The free-wheeling diodes of the GAL and GAR types have the data of the inverse diodes of SKM 150 GB 123 D

<sup>7)</sup> V<sub>isol</sub> = 4000 V<sub>rms</sub> on request

<sup>8)</sup> CAL = Controlled Axial Lifetime Technology.

### Cases and mech. data → B6-116

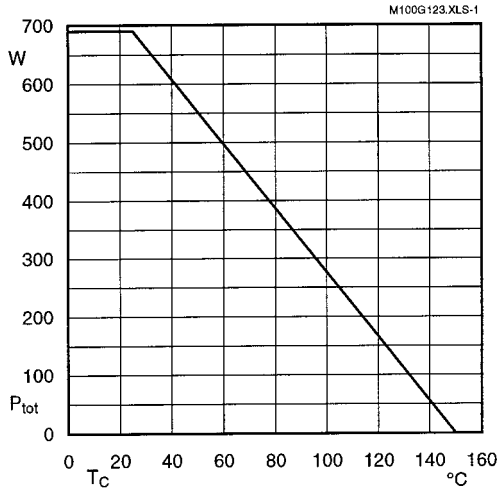

Fig. 1 Rated power dissipation  $P_{tot} = f(T_C)$

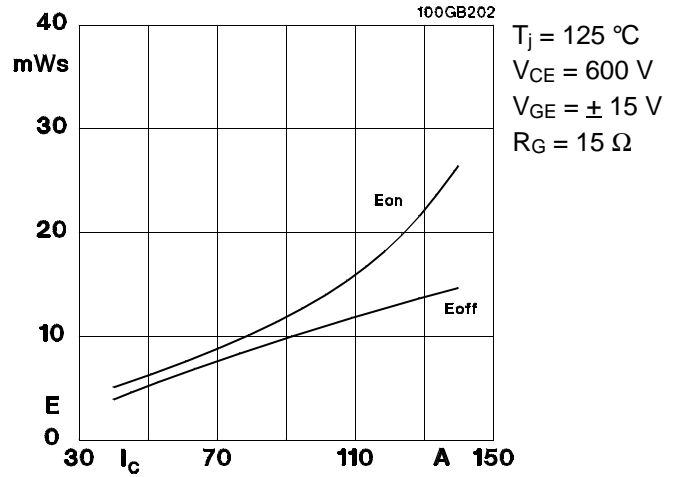

Fig. 2 Turn-on /-off energy  $= f(I_C)$

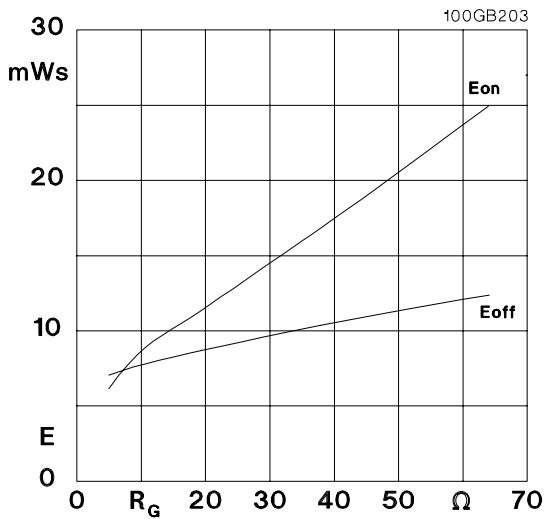

Fig. 3 Turn-on /-off energy  $= f(R_G)$

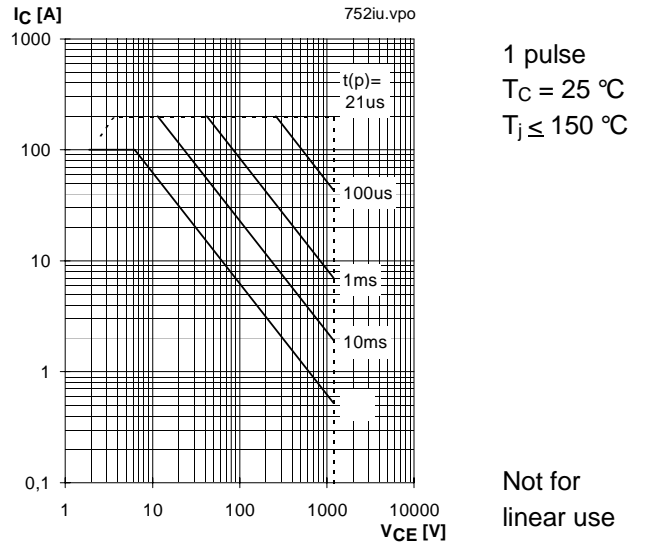

Fig. 4 Maximum safe operating area (SOA)  $I_C = f(V_{CE})$

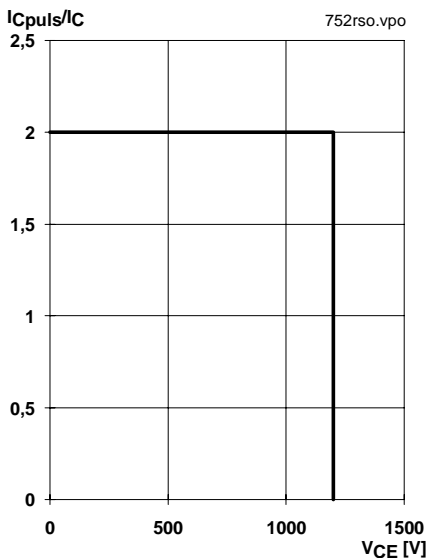

Fig. 5 Turn-off safe operating area (RBSOA)

$T_j \leq 150 \text{ °C}$   
 $V_{GE} = 15 \text{ V}$   
 $R_{Goff} = 15 \text{ } \Omega$   
 $I_C = 75 \text{ A}$

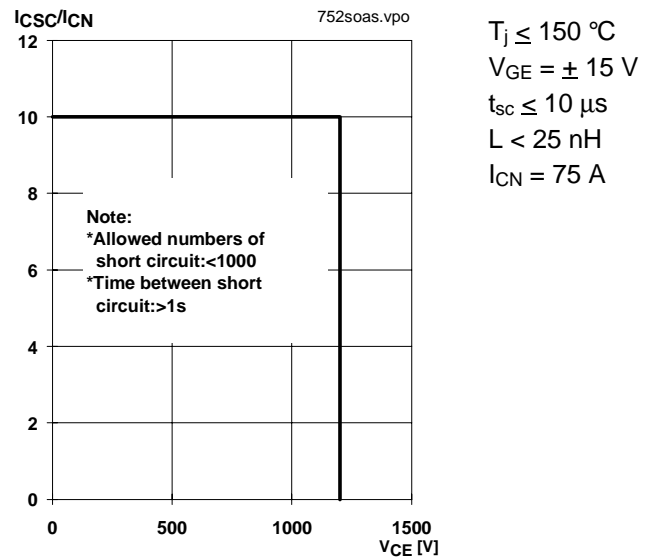

Fig. 6 Safe operating area at short circuit  $I_C = f(V_{CE})$

$T_j \leq 150 \text{ °C}$   
 $V_{GE} = \pm 15 \text{ V}$   
 $t_{sc} \leq 10 \text{ } \mu\text{s}$   
 $L < 25 \text{ nH}$   
 $I_{CN} = 75 \text{ A}$

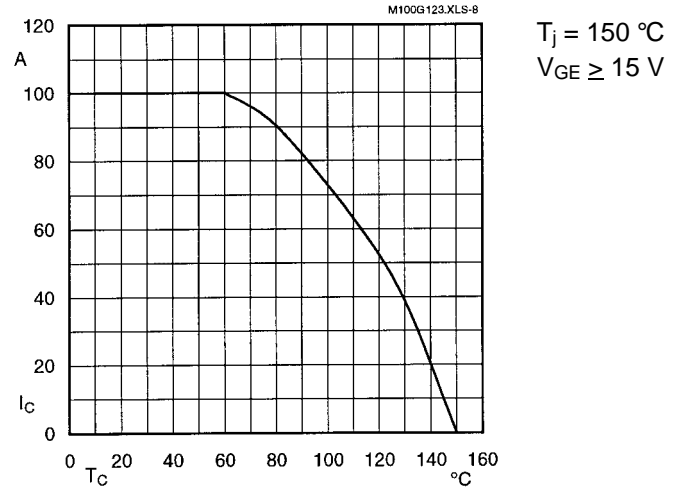

Fig. 8 Rated current vs. temperature  $I_C = f(T_C)$

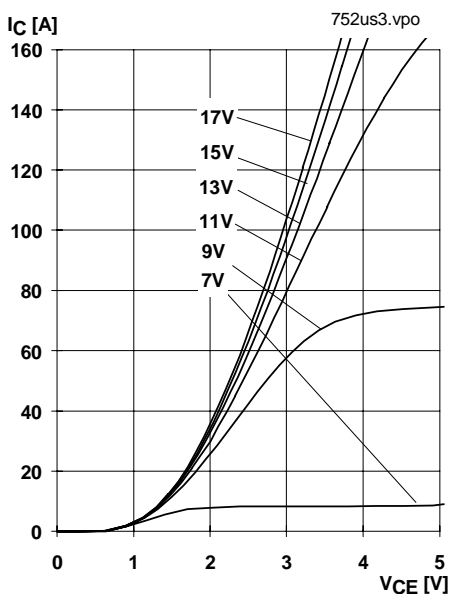

Fig. 9 Typ. output characteristic,  $t_p = 80\text{ }\mu\text{s}$ ;  $25\text{ }^\circ\text{C}$

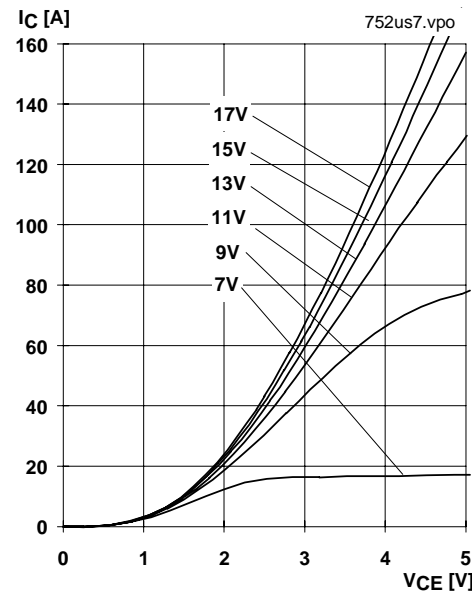

Fig. 10 Typ. output characteristic,  $t_p = 80\text{ }\mu\text{s}$ ;  $125\text{ }^\circ\text{C}$

$$P_{\text{cond}(t)} = V_{\text{CEsat}(t)} \cdot I_{\text{C}(t)}$$

$$V_{\text{CEsat}(t)} = V_{\text{CE(TO)(Tj)}} + r_{\text{CE(Tj)}} \cdot I_{\text{C}(t)}$$

$$V_{\text{CE(TO)(Tj)}} \leq 1,5 + 0,002 (T_j - 25) \text{ [V]}$$

$$\text{typ.: } r_{\text{CE(Tj)}} = 0,013 + 0,00005 (T_j - 25) \text{ [\Omega]}$$

$$\text{max.: } r_{\text{CE(Tj)}} = 0,020 + 0,00007 (T_j - 25) \text{ [\Omega]}$$

$$\text{valid for } V_{\text{GE}} = +15 \frac{+2}{-1} \text{ [V]; } I_{\text{C}} > 0,3 I_{\text{Cnom}}$$

Fig. 11 Saturation characteristic (IGBT)  
Calculation elements and equations

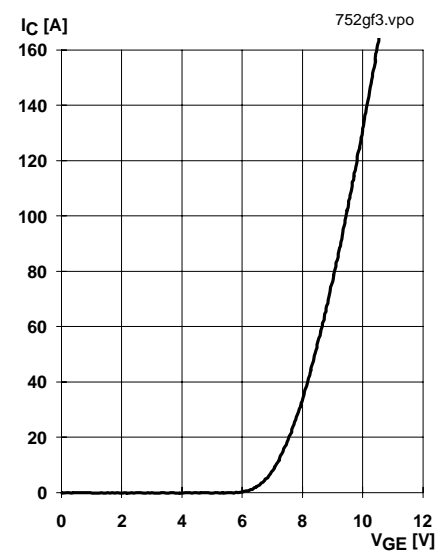

Fig. 12 Typ. transfer characteristic,  $t_p = 80\text{ }\mu\text{s}$ ;  $V_{\text{CE}} = 20\text{ V}$

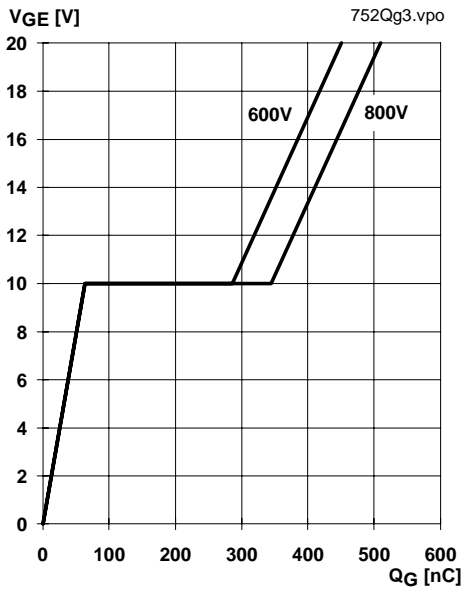
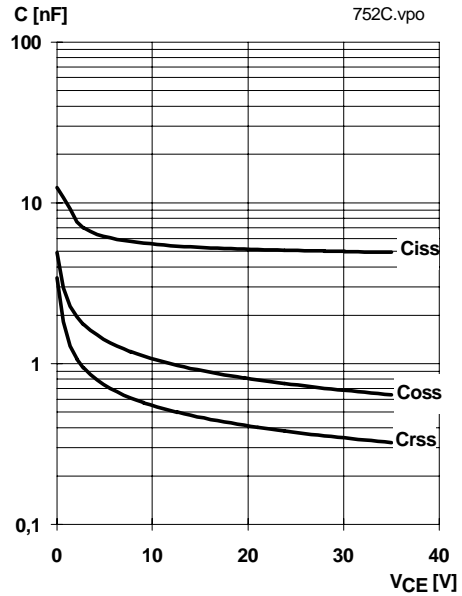

Fig. 13 Typ. gate charge characteristic

$I_{Cpuls} = 75 \text{ A}$



$V_{GE} = 0 \text{ V}$   
 $f = 1 \text{ MHz}$

Fig. 14 Typ. capacitances vs.  $V_{CE}$

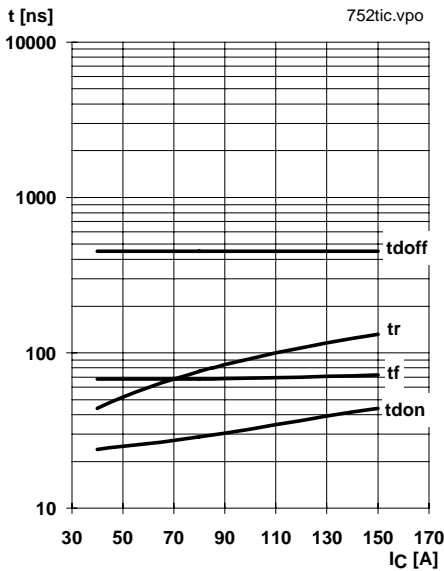
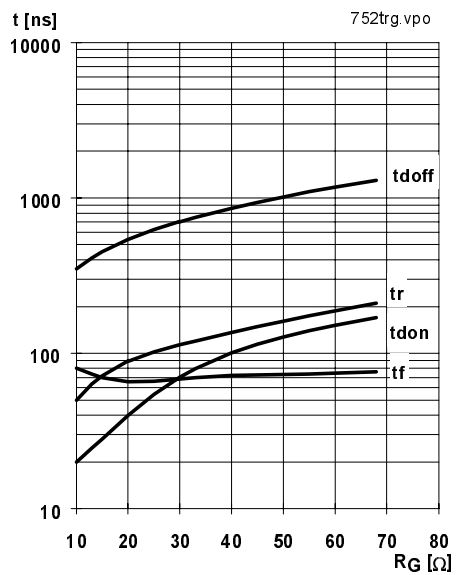

Fig. 15 Typ. switching times vs.  $I_C$

$T_j = 125 \text{ }^\circ\text{C}$   
 $V_{CE} = 600 \text{ V}$   
 $V_{GE} = \pm 15 \text{ V}$   
 $R_{Gon} = 15 \text{ } \Omega$   
 $R_{Goff} = 15 \text{ } \Omega$   
induct. load



$T_j = 125 \text{ }^\circ\text{C}$   
 $V_{CE} = 600 \text{ V}$   
 $V_{GE} = \pm 15 \text{ V}$   
 $I_C = 75 \text{ A}$   
induct. load

Fig. 16 Typ. switching times vs. gate resistor  $R_G$

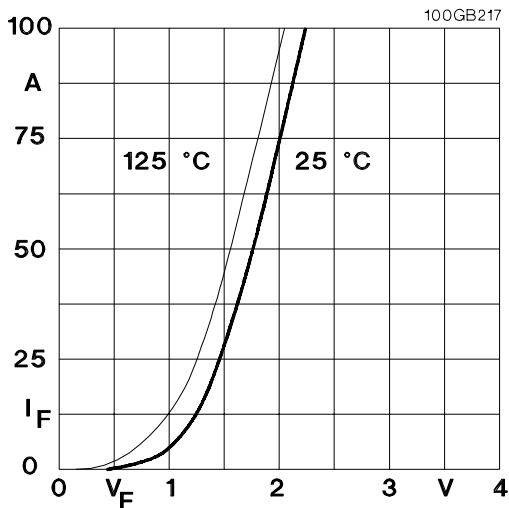

Fig. 17 Typ. CAL diode forward characteristic

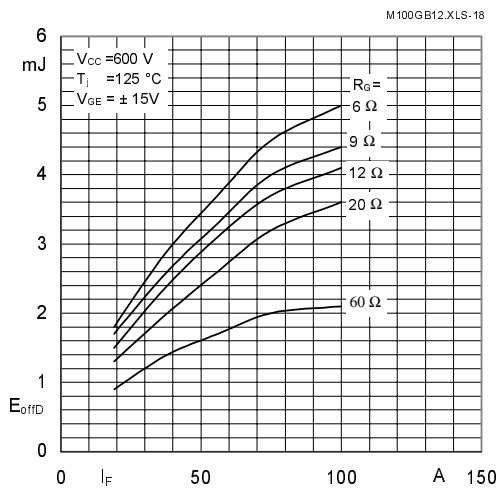

Fig. 18 Diode turn-off energy dissipation per pulse

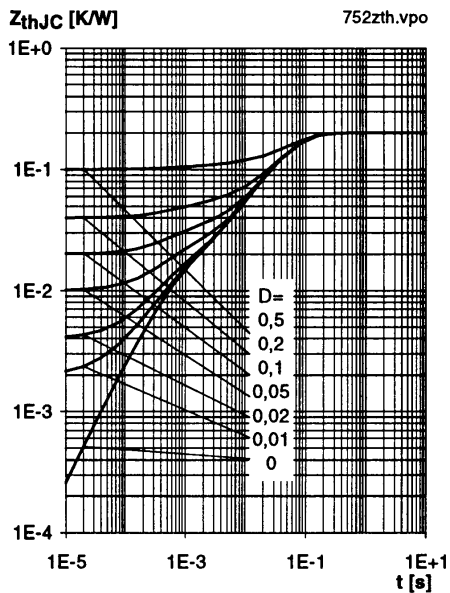

Fig. 19 Transient thermal impedance of IGBT  
 $Z_{thJC} = f(t_p)$ ;  $D = t_p / t_c = t_p \cdot f$

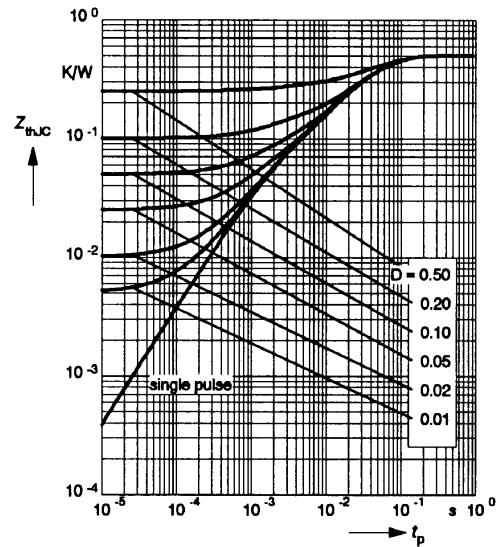

Fig. 20 Transient thermal impedance of inverse CAL diodes  
 $Z_{thJC} = f(t_p)$ ;  $D = t_p / t_c = t_p \cdot f$

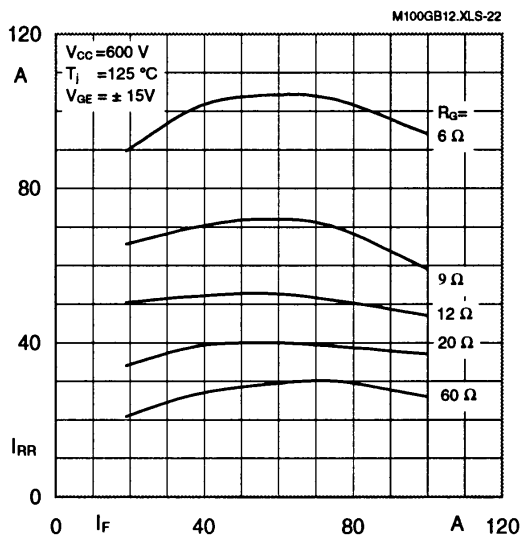

Fig. 22 Typ. CAL diode peak reverse recovery current  $I_{RR} = f(I_F; R_G)$

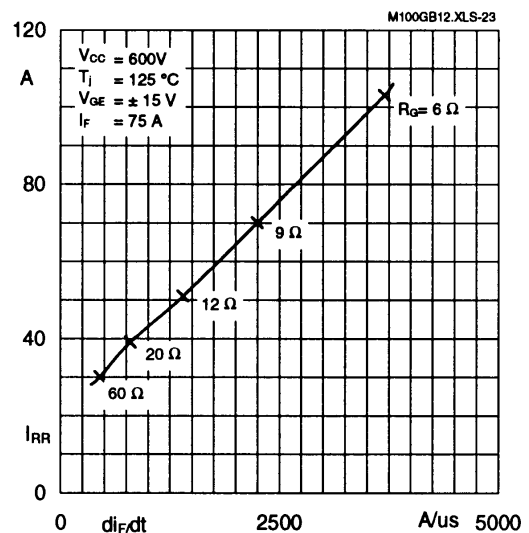

Fig. 23 Typ. CAL diode peak reverse recovery current  $I_{RR} = f(di_F/dt)$

## Typical Applications

### include

- Switched mode power supplies
- DC servo and robot drives
- Inverters
- DC choppers (versions GAR; GAL)
- AC motor speed control
- Inductive heating
- UPS Uninterruptable power supplies
- General power switching applications
- Electronic (also portable) welders
- Pulse frequencies also above 15 kHz

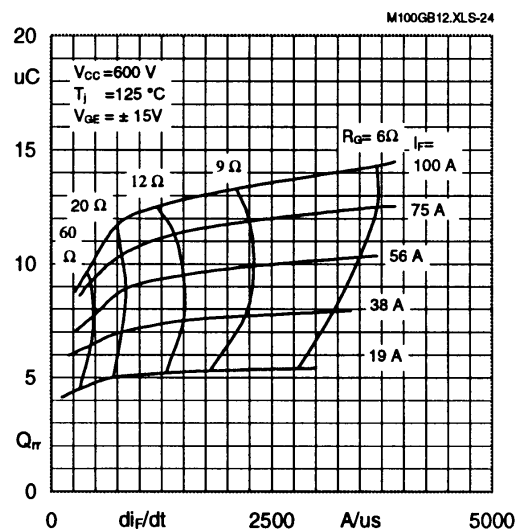

Fig. 24 Typ. CAL diode recovered charge  $Q_{rr} = f(di/dt)$

**SEMITRANS 2**

Case D 61

UL Recognized

File no. E 63 532

CASED61

SKM 100 GB 123 D

SKM 100 GB 173 D

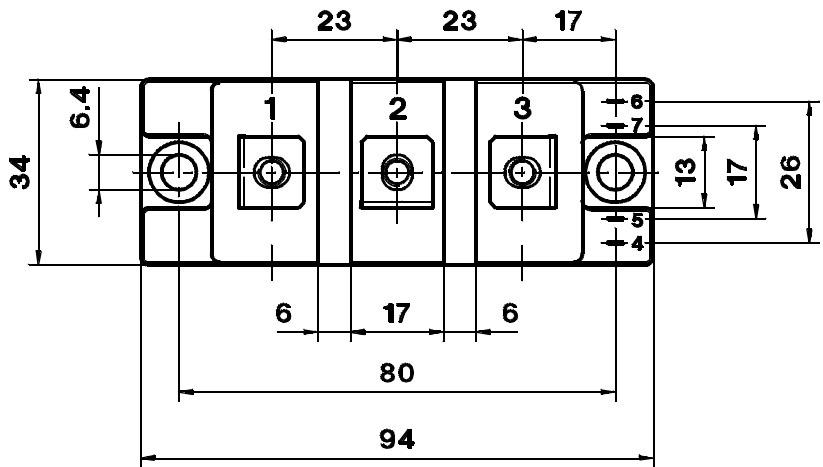
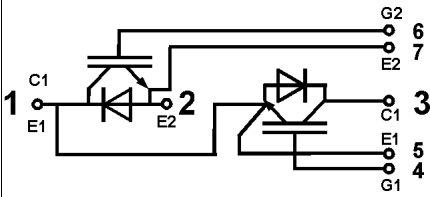
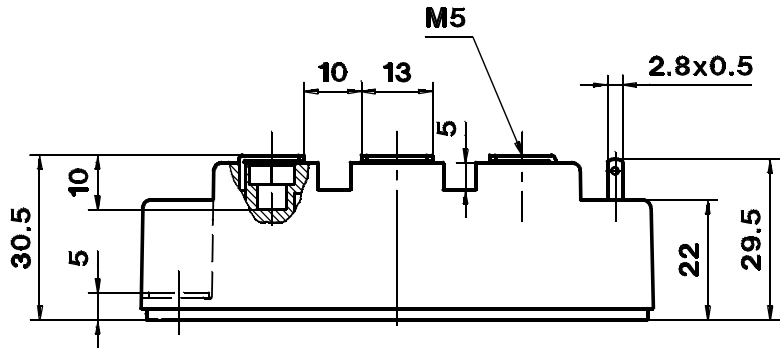

Dimensions in mm

**SKM 100 GAL 123 D**

Case D 62 (→ D 61)

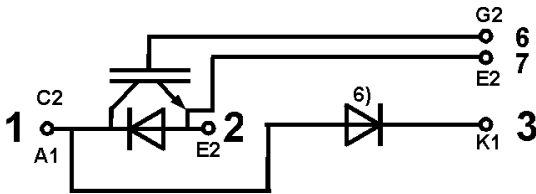

**SKM 100 GAR 123 D**

Case D 63 (→ D 61)

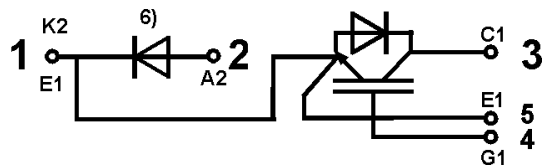

Case outline and circuit diagrams

Mechanical Data		Values			Units
Symbol	Conditions	min.	typ.	max.	
M <sub>1</sub>	to heatsink, SI Units (M6)	3	—	5	Nm
	to heatsink, US Units	27	—	44	lb.in.
M <sub>2</sub>	for terminals, SI Units (M5)	2,5	—	5	Nm
	for terminals US Units	22	—	44	lb.in.
a		—	—	5x9,81	m/s <sup>2</sup>
w		—	—	160	g

This is an electrostatic discharge sensitive device (ESDS). Please observe the international standard IEC 747-1, Chapter IX.

Eight devices are supplied in one SEMIBOX A without mounting hardware, which can be ordered separately under Ident No. 33321100 (for 10 SEMITRANS 2). Larger packing units of 20 and 42 pieces are used if suitable

Accessories → B 6 - 4.  
SEMIBOX → C - 1.

<sup>6)</sup> Freewheeling diode → B 6 - 111, remark 6.