

Coaxial Amplifier

ZHL-1042J+ ZHL-1042JX+

50Ω Medium High Power 10 to 4200 MHz

Features

- wideband, 10 to 4200 MHz
- high IP3, +35 dBm typ.
- low noise, 6 dB min.

Applications

- communication systems
- laboratory

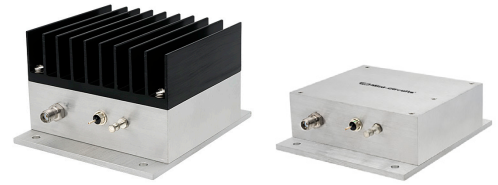

Generic photo used for illustration purposes only

Model No.	ZHL-1042J+	ZHL-1042JX+ [▲]
Case Style	NN92	
Connectors	SMA	

+RoHS Compliant
The +Suffix identifies RoHS Compliance. See our web site for RoHS Compliance methodologies and qualifications

Electrical Specifications at 25°C

Parameter	Condition (MHz)	ZHL-1042J+ ZHL-1042JX+ [▲]			Units
		Min.	Typ.	Max.	
Frequency Range		10	—	4200	MHz
Gain	10-4200	24	27	32	dB
Gain Flatness	10-4200	—	±1.2	±1.7	dB
Output Power at 1dB compression	10-4200	+20	+22	—	dBm
Output Power at 3dB compression	10-4200	+21	+23	—	dBm
Noise Figure	10-4200	—	6.0	—	dB
Output third order intercept point	10-4200	—	+35	—	dBm
Input VSWR	10-4200	—	—	2.5	:1
Output VSWR	10-4200	—	—	2.5	:1
DC Supply Voltage		—	15	—	V
Supply Current		—	—	0.330	A

Open load is not recommended, potentially can cause damage.
With no load derate max. input power by 20 dB.

[▲]Heat sink not included. Alternative heat sinking and heat removal must be provided by the user to limit maximum base-plate temperature to 65°C, in order to ensure proper performance. For reference, this requires thermal resistance of user's external heat sink to be 2.2°C/W max.

Maximum Ratings

Parameter	Ratings
Operating Temperature	-20°C to 65°C
Storage Temperature	-55°C to 100°C
DC Voltage	+20V
Input RF Power (no damage)	+10 dBm

Permanent damage may occur if any of these limits are exceeded.

Notes

- A. Performance and quality attributes and conditions not expressly stated in this specification document are intended to be excluded and do not form a part of this specification document.
 B. Electrical specifications and performance data contained in this specification document are based on Mini-Circuit's applicable established test performance criteria and measurement instructions.
 C. The parts covered by this specification document are subject to Mini-Circuits standard limited warranty and terms and conditions (collectively, "Standard Terms"); Purchasers of this part are entitled to the rights and benefits contained therein. For a full statement of the Standard Terms and the exclusive rights and remedies thereunder, please visit Mini-Circuits' website at www.minicircuits.com/MCLStore/terms.jsp



Outline Drawing for models with heatsink

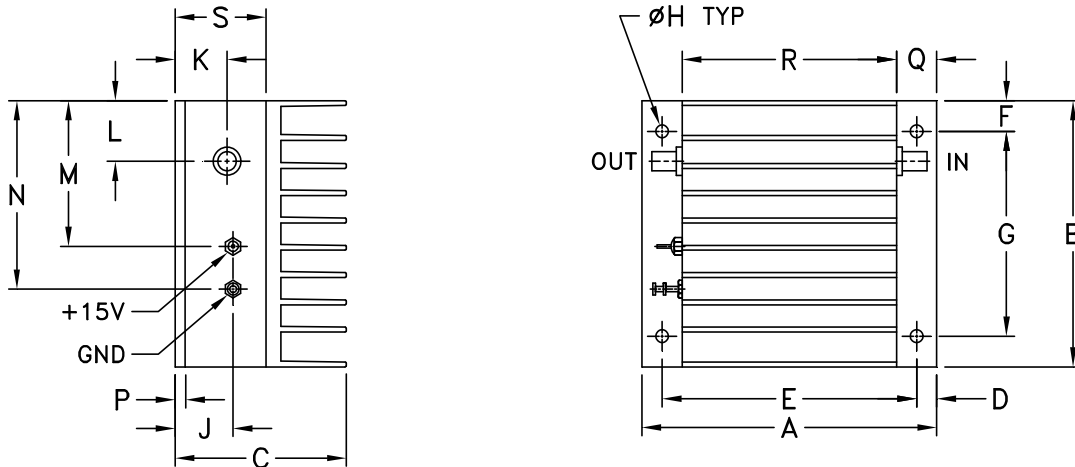

MOUNTING INFORMATION FOR MODELS WITHOUT HEATSINK

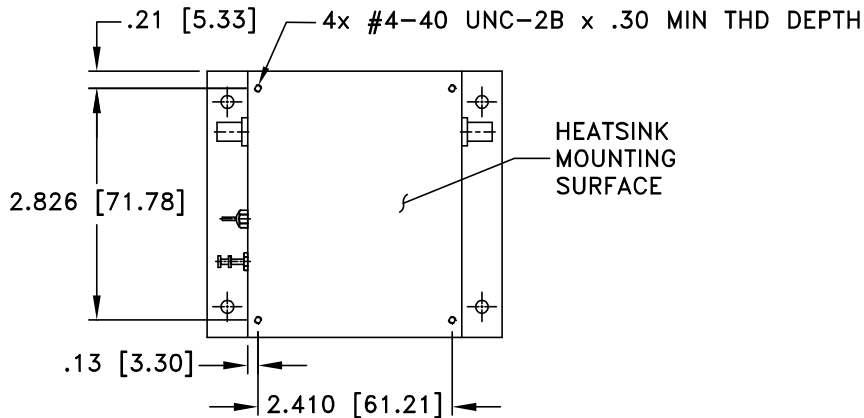

Outline Dimensions (inch/mm)

A	B	C	D	E	F	G	H	J	K	L	M	N	P	Q	R	S	wt
3.66	3.25	2.13	.25	3.16	.38	2.50	.156	.72	.64	.74	1.78	2.30	.125	.50	2.66	1.13	grams*
92.96	82.55	54.10	6.35	80.26	9.65	63.50	3.96	18.29	16.26	18.80	45.21	58.42	3.18	12.70	67.56	28.7	500.0
																	*362 grams without heatsink

Notes

- A. Performance and quality attributes and conditions not expressly stated in this specification document are intended to be excluded and do not form a part of this specification document.
- B. Electrical specifications and performance data contained in this specification document are based on Mini-Circuit's applicable established test performance criteria and measurement instructions.
- C. The parts covered by this specification document are subject to Mini-Circuits standard limited warranty and terms and conditions (collectively, "Standard Terms"); Purchasers of this part are entitled to the rights and benefits contained therein. For a full statement of the Standard Terms and the exclusive rights and remedies thereunder, please visit Mini-Circuits' website at www.minicircuits.com/MCLStore/terms.jsp

Typical Performance Data/Curves

ZHL-1042J+ ZHL-1042JX+

FREQUENCY (MHz)	GAIN (dB)	DIRECTIVITY (dB)	VSWR (:1)		POUT at 1 dB COMPR. (dBm)	NOISE FIGURE (dB)	IP3 (dBm)
	15V	15V	IN	OUT	15V	15V	15V
10	27.79	29.01	2.29	2.11	23.20	5.21	33.56
300	28.09	18.28	1.56	1.67	23.35	4.10	38.81
600	27.78	18.55	1.65	1.38	22.89	4.11	40.42
900	27.83	18.03	1.62	1.12	22.78	4.15	42.12
1200	28.19	16.76	1.49	1.19	23.51	4.27	45.58
1500	28.50	15.16	1.45	1.52	24.25	4.35	49.14
1800	28.22	14.69	1.46	1.84	24.02	4.53	46.70
2100	27.95	14.64	1.37	1.94	24.20	4.60	44.94
2400	27.58	14.89	1.38	1.77	24.62	4.72	48.99
2700	27.21	15.26	1.55	1.51	24.31	4.79	47.16
3000	26.86	15.57	1.59	1.48	24.21	4.83	43.89
3300	26.61	15.50	1.36	1.61	24.24	4.96	42.27
3600	26.79	15.54	1.03	1.59	24.03	4.96	41.05
3900	26.67	16.18	1.28	1.39	23.59	4.97	39.79
4200	26.56	17.35	1.21	1.28	22.48	5.01	38.07

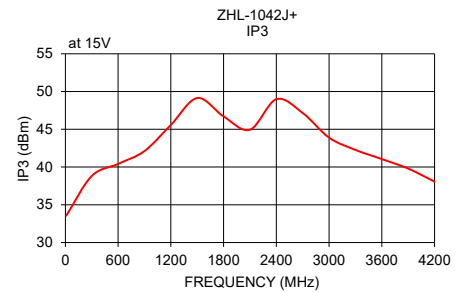
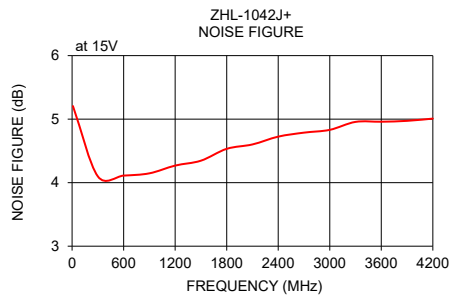
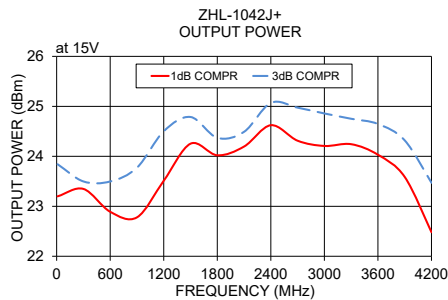
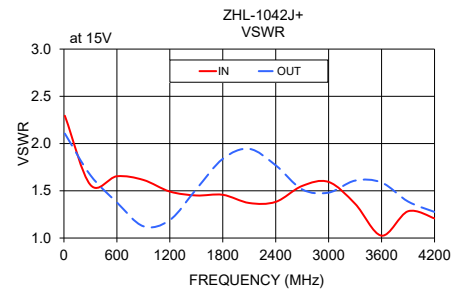
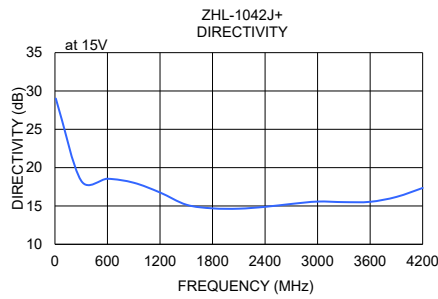
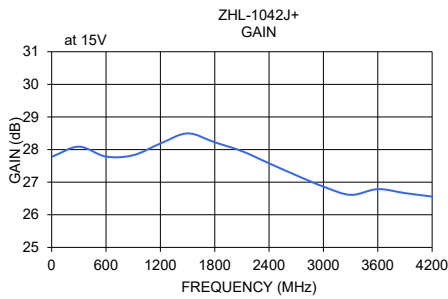

Notes

- A. Performance and quality attributes and conditions not expressly stated in this specification document are intended to be excluded and do not form a part of this specification document.
- B. Electrical specifications and performance data contained in this specification document are based on Mini-Circuit's applicable established test performance criteria and measurement instructions.
- C. The parts covered by this specification document are subject to Mini-Circuits standard limited warranty and terms and conditions (collectively, "Standard Terms"); Purchasers of this part are entitled to the rights and benefits contained therein. For a full statement of the Standard Terms and the exclusive rights and remedies thereunder, please visit Mini-Circuits' website at www.minicircuits.com/MCLStore/terms.jsp

