

Coaxial Low Noise Amplifier

ZHL-1217HLN+ ZHL-1217HLNX+

50Ω 1200 to 1700 MHz

Features

- very low noise figure, 1.5 dB max.
- wideband, 1200 to 1700 MHz
- high dynamic range

Applications

- GPS
- mar sat
- communication systems

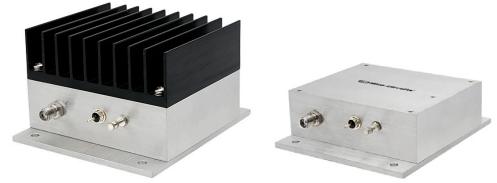

Generic photo used for illustration purposes only

Model No.	ZHL-1217HLN+	ZHL-1217HLNX+ [▲]
Case Style	NN92	
Connectors	SMA	

+RoHS Compliant
The +Suffix identifies RoHS Compliance. See our web site for RoHS Compliance methodologies and qualifications

Electrical Specifications

Parameter	Frequency (MHz)	ZHL-1217HLN+			ZHL-1217HLNX+ [▲]			Units
		Min.	Typ.	Max.	Min	Typ.	Max.	
Frequency Range		1200		1700	1200		1700	MHz
Noise Figure	1200-1700	—	0.75	1.5	—	0.75	1.5	dB
Gain	1200-1700	36	42	—	36	42	—	dB
Gain Flatness	1200-1700	—	—	±1.0	—	—	±1.0	dB
Output Power at 1dB compression	1200-1700	—	+26	—	—	+26	—	dBm
Output third order intercept point	1200-1700	—	+36	—	—	+36	—	dBm
Input VSWR	1200-1700	—	1.4	—	—	1.4	—	:1
Output VSWR	1200-1700	—	1.3	—	—	1.3	—	:1
DC Supply Voltage		—	15	—	—	15	—	V
Supply Current ¹		—	650	725	—	650	725	mA

Noise Figure specified at room temperature, increases to 2.3 dB max. at +65°C

Open load is not recommended, potentially can cause damage.

With no load derate max input power by 20 dB

[▲] Heat sink not included. Alternative heat sinking and heat removal must be provided by the user to limit maximum base-plate temperature to 65°C, in order to ensure proper performance. For reference, this requires thermal resistance of user's external heat sink to be 1.8°C/W max.

Maximum Ratings

Parameter	Ratings
Operating Temperature	-20°C to 65°C
Storage Temperature	-55°C to 100°C
DC Voltage	20V
Input RF Power (no damage)	+10 dBm

Permanent damage may occur if any of these limits are exceeded.

Notes

- Performance and quality attributes and conditions not expressly stated in this specification document are intended to be excluded and do not form a part of this specification document.
- Electrical specifications and performance data contained in this specification document are based on Mini-Circuit's applicable established test performance criteria and measurement instructions.
- The parts covered by this specification document are subject to Mini-Circuits standard limited warranty and terms and conditions (collectively, "Standard Terms"); Purchasers of this part are entitled to the rights and benefits contained therein. For a full statement of the Standard Terms and the exclusive rights and remedies thereunder, please visit Mini-Circuits' website at www.minicircuits.com/MCLStore/terms.jsp



Outline Drawing for models with heatsink

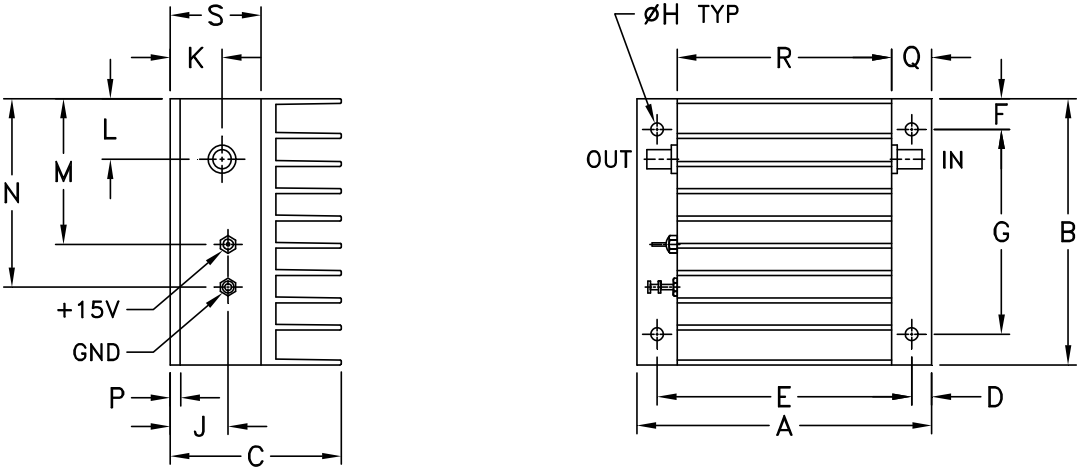

MOUNTING INFORMATION FOR MODELS WITHOUT HEATSINK

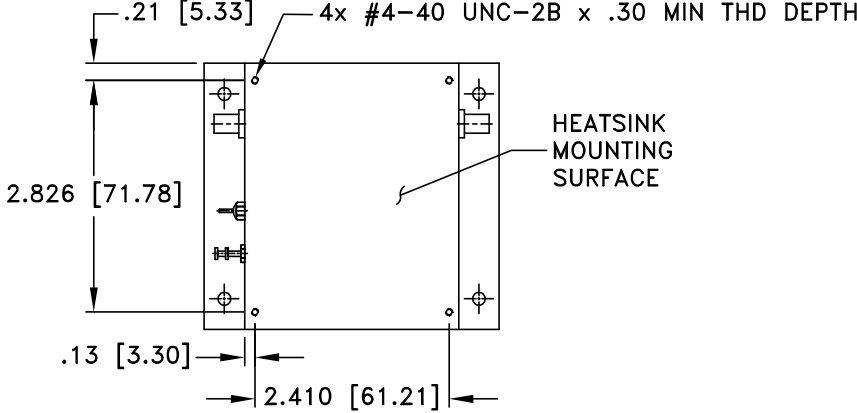

Outline Dimensions (inch/mm)

A	B	C	D	E	F	G	H	J	K	L	M	N	P	Q	R	S	wt
3.66	3.25	2.13	.25	3.16	.38	2.50	.156	.72	.64	.74	1.78	2.30	.125	.50	2.66	1.13	grams*
92.96	82.55	54.10	6.35	80.26	9.65	63.50	3.96	18.29	16.26	18.80	45.21	58.42	3.18	12.70	67.56	28.7	500.0
*362 grams without heatsink																	

Notes
 A. Performance and quality attributes and conditions not expressly stated in this specification document are intended to be excluded and do not form a part of this specification document.
 B. Electrical specifications and performance data contained in this specification document are based on Mini-Circuit's applicable established test performance criteria and measurement instructions.
 C. The parts covered by this specification document are subject to Mini-Circuits standard limited warranty and terms and conditions (collectively, "Standard Terms"); Purchasers of this part are entitled to the rights and benefits contained therein. For a full statement of the Standard Terms and the exclusive rights and remedies thereunder, please visit Mini-Circuits' website at www.minicircuits.com/MCLStore/terms.jsp

Typical Performance Data/Curves

ZHL-1217HLN+ ZHL-1217HLNX+

FREQUENCY (MHz)	GAIN (dB)	DIRECTIVITY (dB)	VSWR (:1)		POUT at 1 dB COMPR. (dBm)	NOISE FIGURE (dB)	IP3 (dBm)
	15V	15V	IN	OUT	15V	15V	15V
1200	41.87	49.61	1.42	1.23	26.54	0.75	37.71
1230	41.92	49.26	1.33	1.23	26.58	0.77	37.73
1260	41.97	47.05	1.27	1.23	26.61	0.73	37.93
1290	42.04	46.11	1.24	1.24	26.66	0.75	38.09
1320	42.11	49.96	1.23	1.26	26.73	0.75	38.33
1350	42.20	43.66	1.24	1.28	26.75	0.75	38.60
1380	42.29	42.83	1.27	1.31	26.82	0.70	39.06
1410	42.37	45.16	1.31	1.33	27.01	0.76	39.38
1440	42.45	44.03	1.35	1.35	27.04	0.74	39.73
1470	42.52	43.46	1.39	1.37	27.12	0.77	39.87
1500	42.55	40.64	1.44	1.38	27.20	0.79	40.32
1550	42.52	39.97	1.50	1.36	27.24	0.78	40.66
1600	42.42	40.39	1.48	1.33	27.38	0.80	41.16
1650	42.29	48.58	1.47	1.27	27.44	0.77	41.51
1700	42.01	43.77	1.44	1.19	27.31	0.73	41.40

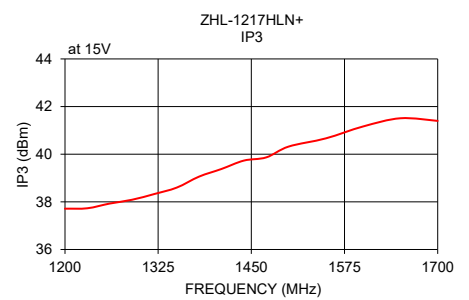
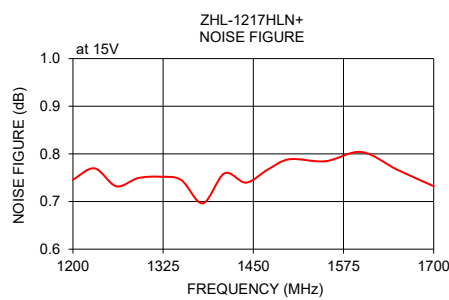
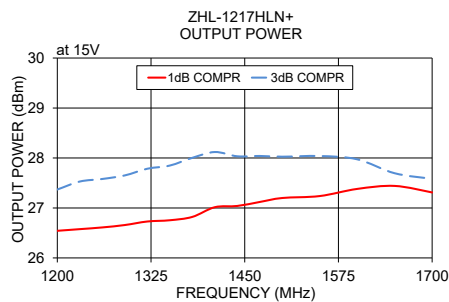
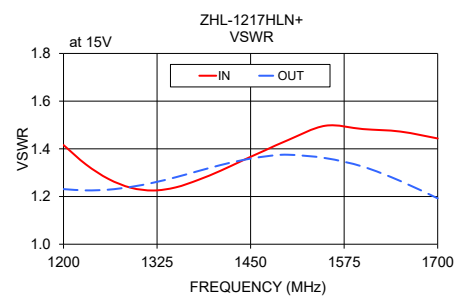
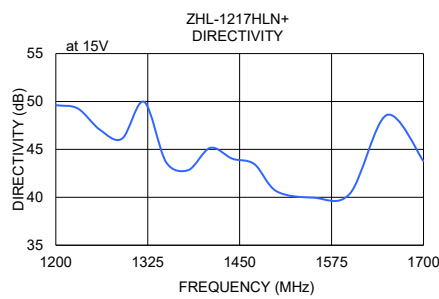
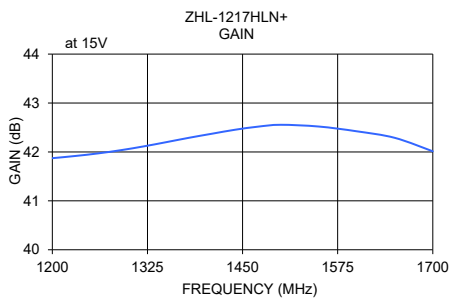

Notes

- A. Performance and quality attributes and conditions not expressly stated in this specification document are intended to be excluded and do not form a part of this specification document.
- B. Electrical specifications and performance data contained in this specification document are based on Mini-Circuit's applicable established test performance criteria and measurement instructions.
- C. The parts covered by this specification document are subject to Mini-Circuits standard limited warranty and terms and conditions (collectively, "Standard Terms"); Purchasers of this part are entitled to the rights and benefits contained therein. For a full statement of the Standard Terms and the exclusive rights and remedies thereunder, please visit Mini-Circuits' website at www.minicircuits.com/MCLStore/terms.jsp

