

Coaxial High Pass Filter

ZX75HP-147-S+

50Ω 250 to 3000 MHz

The Big Deal

- Low insertion loss
- High rejection
- Connectorized package



Generic photo used for illustration purposes only
CASE STYLE: KE1467

Product Overview

ZX75HP-147-S+ is a High pass filter in a rugged connectorized package covering 250 to 3000 MHz. This filter will find its application in TV Broadcast, point-to-point military radio and cordless telephones. It has repeatable performance across production lots and consistent performance across temperature.

Key Features

Feature	Advantages
Low insertion loss	Can be used in high performance applications.
Good rejection	This enables the filter to attenuate spurious signals and reject harmonics for broad band frequency.
Connectorized package	The connectorized package is easy to interface with other devices and well suited for test setups.

Notes

- A. Performance and quality attributes and conditions not expressly stated in this specification document are intended to be excluded and do not form a part of this specification document.
B. Electrical specifications and performance data contained in this specification document are based on Mini-Circuit's applicable established test performance criteria and measurement instructions.
C. The parts covered by this specification document are subject to Mini-Circuits standard limited warranty and terms and conditions (collectively, "Standard Terms"); Purchasers of this part are entitled to the rights and benefits contained therein. For a full statement of the Standard Terms and the exclusive rights and remedies thereunder, please visit Mini-Circuits' website at www.minicircuits.com/MCLStore/terms.jsp



Coaxial High Pass Filter

ZX75HP-147-S+

50Ω 250 to 3000 MHz



Generic photo used for illustration purposes only

CASE STYLE: KE1467

Connectors	Model
SMA-MF	ZX75HP-147-S+

Electrical Specifications at 25°C

Parameter	F#	Frequency (MHz)	Min.	Typ.	Max.	Unit	
Stop Band	Rejection Loss	DC-F1	DC-100	20	32	-	dB
	VSWR	DC-F1	DC-100	-	53	-	:1
Pass Band	Insertion Loss	F2-F3	250-3000	-	0.6	1.5	dB
	VSWR	F2-F3	250-3000	-	1.4	-	:1

Features

- Wide band, 250 MHz to 3000 MHz
- High rejection
- Connectorized package

Applications

- TV Broadcast
- Point-to-point military radio
- Cordless telephones

Functional Schematic

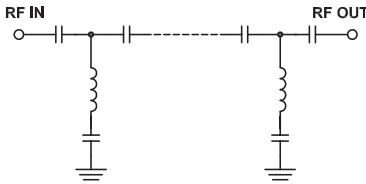

Maximum Ratings

Operating Temperature	-40°C to 85°C
Storage Temperature	-55°C to 100°C
RF Power Input	0.5 W.

Permanent damage may occur if any of these limits are exceeded.

Typical Performance Data at 25°C

Frequency (MHz)	Insertion Loss (dB)	VSWR (:1)
0.5	96.08	1737.18
50.0	77.58	434.30
75.0	52.95	144.77
85.0	44.52	102.19
100.0	33.05	57.91
117.0	20.97	28.49
133.0	10.26	10.07
141.0	5.74	4.82
147.0	3.34	2.73
156.0	1.58	1.42
188.0	0.72	1.16
206.0	0.58	1.07
250.0	0.44	1.20
375.0	0.29	1.21
725.0	0.19	1.09
1150.0	0.26	1.26
1700.0	0.33	1.31
2300.0	0.35	1.23
2825.0	0.39	1.17
3000.0	0.41	1.19

Typical Frequency Response

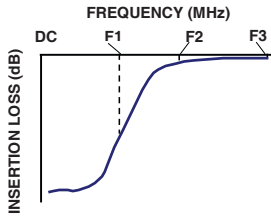

+RoHS Compliant

The +Suffix identifies RoHS Compliance. See our web site for RoHS Compliance methodologies and qualifications

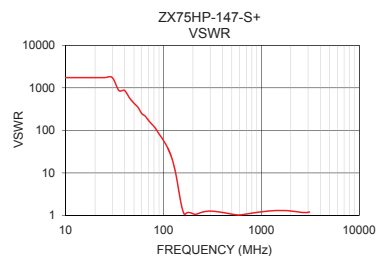
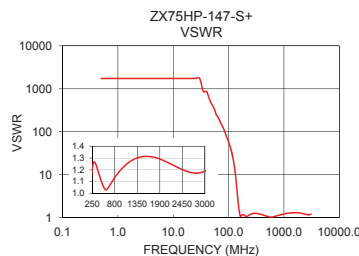
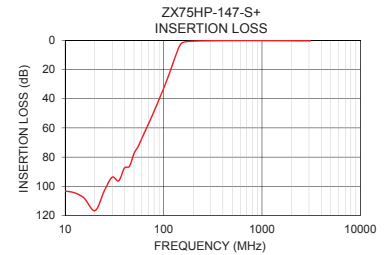
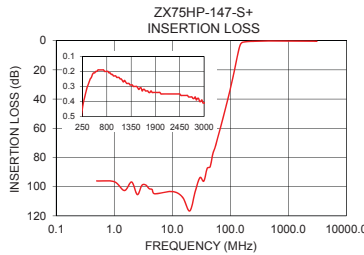

Notes

- Performance and quality attributes and conditions not expressly stated in this specification document are intended to be excluded and do not form a part of this specification document.
- Electrical specifications and performance data contained in this specification document are based on Mini-Circuit's applicable established test performance criteria and measurement instructions.
- The parts covered by this specification document are subject to Mini-Circuits standard limited warranty and terms and conditions (collectively, "Standard Terms"); Purchasers of this part are entitled to the rights and benefits contained therein. For a full statement of the Standard Terms and the exclusive rights and remedies thereunder, please visit Mini-Circuits' website at www.minicircuits.com/MCLStore/terms.jsp



Coaxial Connections

INPUT	SMA-Male
OUTPUT	SMA-Female

Outline Drawing

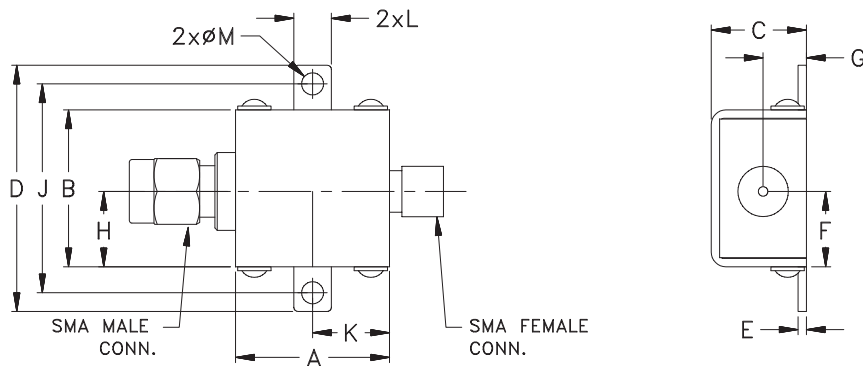

Outline Dimensions ($\frac{\text{inch}}{\text{mm}}$)

A	B	C	D	E	F	G
.74	.75	.46	1.18	.04	.362	.21
18.80	19.05	11.68	29.97	1.02	9.19	5.33
H	J	K	L	M		Wt.
.362	1.00	.37	.18	.11		grams
9.19	25.40	9.40	4.57	2.79		24.4

Note: Please refer to case style drawing for details

Notes

- A. Performance and quality attributes and conditions not expressly stated in this specification document are intended to be excluded and do not form a part of this specification document.
- B. Electrical specifications and performance data contained in this specification document are based on Mini-Circuit's applicable established test performance criteria and measurement instructions.
- C. The parts covered by this specification document are subject to Mini-Circuits standard limited warranty and terms and conditions (collectively, "Standard Terms"); Purchasers of this part are entitled to the rights and benefits contained therein. For a full statement of the Standard Terms and the exclusive rights and remedies thereunder, please visit Mini-Circuits' website at www.minicircuits.com/MCLStore/terms.jsp

