



COAXIAL WIDEBAND

Digital Step Attenuator

ZX76-31A-PNS+

50Ω 31 dB, 1 dB Step DC to 4 GHz

THE BIG DEAL

- 5-bit digital step attenuator
- High speed parallel control interface
- Low insertion loss
- Fast attenuation transitions
- No control software or PC required



Generic photo used for illustration purposes only

APPLICATIONS

- Test Setup
- Lab
- Instrumentation

Model No.	ZX76-31A-PNS+
Case Style	HK1149
Connectors	SMA

RoHS Compliant

See our website for RoHS Compliance methodologies and qualifications

PRODUCT OVERVIEW

ZX76-31A-PNS+ is a 5-bit digital step attenuator with parallel control and dual (positive and negative) supply voltage inputs. Attenuation can be set from 0 to 31 dB in 1 dB steps, with 0.1 dB typical accuracy. The attenuator is housed in a compact unibody package, with SMA RF connections and a snap-fit control input.

The high speed parallel control interface supports manual control and integration with a wide range of microcontroller and custom I/O (input / output) control systems. Data is entered into the internal 5-bit register using 5V logic levels and then latched to set the attenuation.

For applications requiring Ethernet / USB control and software support, please review Mini-Circuits' R_DAT series of programmable attenuators at <https://www.minicircuits.com/WebStore/RF-Programmable-Step-Attenuators.html>

KEY FEATURES

Feature	Advantages
Wideband operation, from DC to 4 GHz	Supports a range of applications in communications, satellite and defense.
Excellent RF performance	Low insertion loss and 18 dB typical return loss minimize the impact on overall system performance.
Dual voltage supply inputs	Separate positive & negative supply rails reduce the noise & spurious effects associated with internal negative voltage generators and allow faster attenuation switching (up to 1 MHz).
Parallel control	High speed parallel control, no PC, software control or clock needed. Allows manual control of attenuation setting. Designed for integration with generic control systems at 5V logic levels.



RF ELECTRICAL SPECIFICATIONS, DC - 4 GHz, $T_{AMB}=25^{\circ}\text{C}$, $V_{DD}=+3\text{V}$, $V_{SS}=-3.3\text{V}$

Parameter	Frequency (MHz)	Min.	Typ.	Max.	Units
Insertion Loss @ 0dB Attenuation Setting	DC - 1000	—	1.4	2.0	dB
	1000 - 2400	—	1.9	2.7	
	2400 - 4000	—	2.5	3.3	
Accuracy @ 1 dB Attenuation Setting	DC - 1000	—	± 0.02	± 0.10	dB
	1000 - 2400	—	± 0.05	± 0.15	
	2400 - 4000	—	± 0.10	± 0.25	
Accuracy @ 2 dB Attenuation Setting	DC - 1000	—	± 0.05	± 0.15	dB
	1000 - 2400	—	± 0.15	± 0.25	
	2400 - 4000	—	± 0.15	± 0.35	
Accuracy @ 4 dB Attenuation Setting	DC - 1000	—	± 0.07	± 0.20	dB
	1000 - 2400	—	± 0.15	± 0.25	
	2400 - 4000	—	± 0.23	± 0.50	
Accuracy @ 8 dB Attenuation Setting	DC - 1000	—	± 0.03	± 0.25	dB
	1000 - 2400	—	± 0.15	± 0.50	
	2400 - 4000	—	± 0.60	± 0.80	
Accuracy @ 16 dB Attenuation Setting	DC - 1000	—	± 0.10	± 0.30	dB
	1000 - 2400	—	± 0.15	± 0.70	
	2400 - 4000	—	± 1.10	± 1.45	
Input IP3 (at Min. and Max. Attenuation) ¹	DC - 4000	—	+52	—	dBm
Input Power @ 0.2dB Compression (at Min. and Max. Attenuation) ¹	DC - 4000	—	+24	—	
Input Operating Power	0.010 - 50	—	—	See figure 1	dBm
	50 - 4000	—	—	+24	
Return Loss	DC - 1000	12.5	21	—	dB
	1000 - 2400	11.5	18	—	
	2400 - 4000	10.0	14	—	

1. Input IP3 and 1dB compression degrade below 1 MHz. Input power not to exceed max operating specification for continuous operation.

DC ELECTRICAL SPECIFICATIONS

Parameter	Min.	Typ.	Max.	Units
Positive Supply Voltage, V_{DD}	+2.7	+3	+3.6	V
Positive Supply Current, I_{DD}	—	—	3	mA
Negative Supply Voltage, V_{SS}	-3.6	-3.3	-3.2	V
Negative Supply Current, I_{SS}	—	16	40	μA
Control Input Low	-0.3	—	+0.3x V_{DD}	V
Control Input High	+0.7x V_{DD}	—	+5	V
Control Current	—	—	400	μA

SWITCHING SPECIFICATIONS

Parameter	Min.	Typ.	Max.	Units
Switching Speed, 50% Control to 0.5dB of Attenuation Value	—	1	—	μsec
Switching Control Frequency	—	1	—	MHz

FIGURE 1: Max Input Operating Power vs Frequency

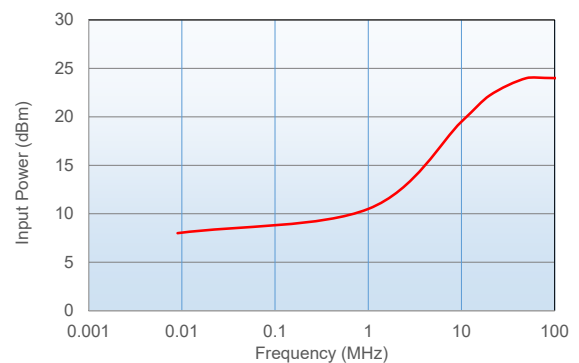



ABSOLUTE MAXIMUM RATINGS

Parameter	Ratings
Operating Temperature	-40°C to 85°C
Storage Temperature	-40°C to 85°C
V _{DD}	-0.3V Min., +5.5V Max.
V _{SS}	-3.6V Min., +0.3V Max.
Voltage on any control input	-0.3V Min., +6V Max.
ESD, HBM	500V
ESD, MM	100V
Input Power	+30dBm

Permanent damage may occur if any of these limits are exceeded. Operating in the range between operating power limits and absolute maximum ratings for extended periods of time may result in reduced life and reliability.

PIN CONFIGURATION

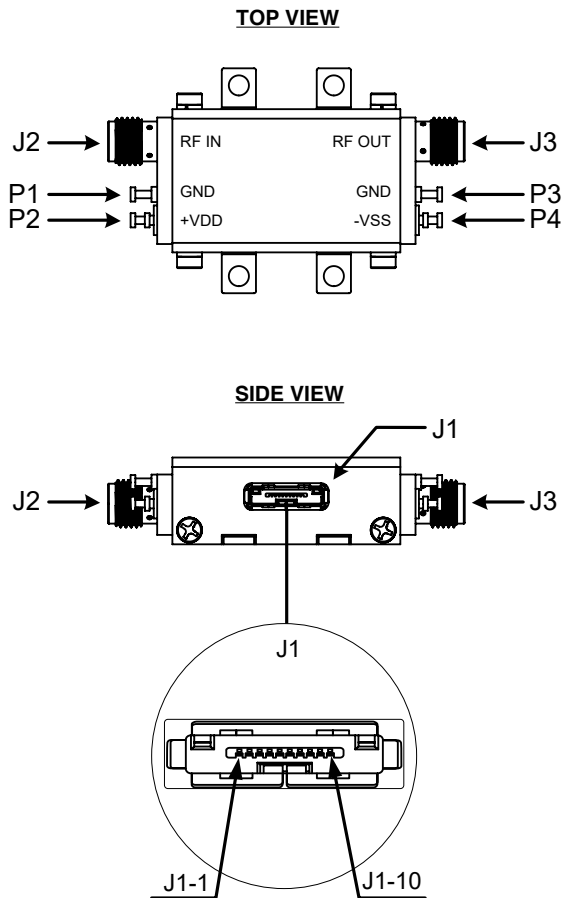

PIN DESCRIPTION

Function	Pin Number	Description
LE	J1-1	Latch Enable Input
C1	J1-2	Control for attenuation bit, 1.0 dB
N/C	J1-3	Not Connected
N/C	J1-4	Not Connected
C16	J1-5	Control for attenuation bit, 16 dB
GND	J1-6	Ground Connection
GND	J1-7	Ground Connection
C4	J1-8	Control for attenuation bit, 4 dB
C8	J1-9	Control for attenuation bit, 8 dB
C2	J1-10	Control for attenuation bit, 2 dB
RF in	J2	RF in port ²
RF out	J3	RF out port ²
GND	P1	Ground Connection
V _{DD}	P2	Positive Supply Voltage
GND	P3	Ground Connection
V _{SS}	P4	Negative Supply Voltage

² Both RF ports must be held at 0VDC or DC blocked with an external series capacitor.



SIMPLIFIED SCHEMATIC

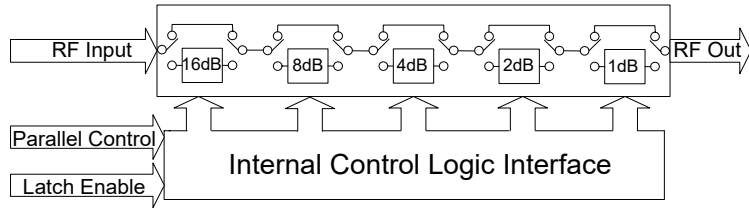

The ZX76-31A-PNS+ parallel interface consists of 6 control bits that select the desired attenuation state, as shown in Table 1: Truth Table.

TABLE 1. TRUTH TABLE

Attenuation State	C16	C8	C4	C2	C1
Reference	0	0	0	0	0
1 (dB)	0	0	0	0	1
2 (dB)	0	0	0	1	0
4 (dB)	0	0	1	0	0
8 (dB)	0	1	0	0	0
16 (dB)	1	0	0	0	0
31 (dB)	1	1	1	1	1

Note: Not all 62 possible combinations of C1 - C31 are shown in table

The parallel interface timing requirements are defined by Figure 1 (Parallel Interface Timing Diagram) and Table 2 (Parallel Interface AC Characteristics), and the switching speed.

For latched parallel programming the Latch Enable (LE) should be held LOW while changing attenuation state control values, then pulse LE HIGH to LOW (per Figure 1) to latch new attenuation state into the device.

For direct parallel programming, the Latch Enable (LE) line should be pulled HIGH. Changing the attenuation state control values will immediately change the device's state to a new attenuation value. Direct mode is ideal for manual control of the device (using hardware, switches, or jumpers).

Control cables for programming can be ordered separately. For details see page 5.

TABLE 2. PARALLEL INTERFACE AC CHARACTERISTICS

Symbol	Parameter	Min.	Units
t_{LEPW}	LE minimum pulse width	10	ns
t_{PDSUP}	Data set-up time before clock rising edge of LE	10	ns
t_{PDHLD}	Data hold time after clock falling edge of LE	10	ns

FIGURE 1: PARALLEL INTERFACE TIMING DIAGRAM

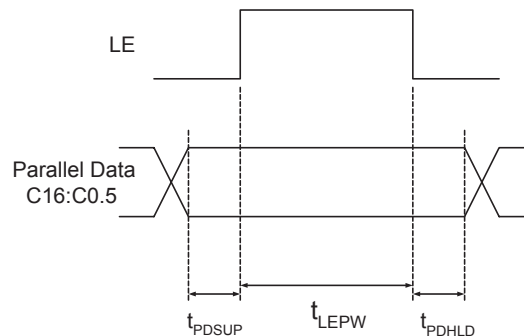

POWER-UP STATE

When the attenuator powers up and LE is logic low, the nominal attenuation is set on 0 dB. When LE is logic high, the nominal attenuation selected upon control logics (see Table 1).



ZX76-WP+ CONTROL CABLE

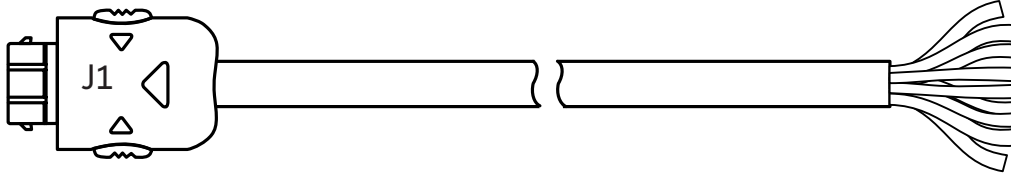

RECOMMENDED ACCESSORIES

An optional ZX76-WP+ is a shielded cable on one end and a connector on the other end designed to mate to the ZX76-31A-PNS+. These bare wires enable the customer to assemble their own cable as required to interface with the ZX76-31A-PNS+ (cable length is 4.9ft/ 1.5meters).

ZX76-WP+ WIRING INFORMATION

J1 Pin Number	Function	Description	Wire Color
J1-1	LE	Latch Enable Input	White
J1-2	C1	Control for attenuation bit, 1.0 dB	Yellow
J1-5	C16	Control for attenuation bit, 16.0 dB	Blue
J1-6	GND	Ground Connection	Black
J1-8	C4	Control for attenuation bit, 4.0 dB	Orange
J1-9	C8	Control for attenuation bit, 8.0 dB	Brown
J1-10	C2	Control for attenuation bit, 2.0 dB	Red

Note: Other pins not connected. Cable shield connected to case ground.



TYPICAL PERFORMANCE DATA (AT 25°C)

Freq. [MHz]	I.Loss [dB]	Attenuation relative to Insertion Loss [dB]						
		@ Attenuation setting [dB]						
		0.5	1	2	4	8	16	31
0.1	-1.21	0.46	-0.01	-0.01	0.00	0.03	0.15	0.23
1	-1.23	0.47	-0.01	-0.01	0.00	0.03	0.15	0.22
10	-1.24	0.47	-0.01	-0.01	0.00	0.03	0.15	0.21
100	-1.27	0.47	-0.01	-0.01	0.00	0.03	0.15	0.22
200	-1.31	0.47	-0.01	-0.01	0.00	0.03	0.15	0.23
400	-1.38	0.47	-0.01	0.00	0.01	0.03	0.15	0.23
500	-1.42	0.47	-0.01	0.00	0.01	0.03	0.15	0.25
700	-1.49	0.47	0.00	0.00	0.01	0.03	0.15	0.25
800	-1.54	0.47	0.00	0.00	0.01	0.03	0.14	0.24
1000	-1.61	0.47	0.00	0.01	0.02	0.02	0.13	0.23
1100	-1.65	0.47	0.00	0.01	0.02	0.02	0.12	0.24
1300	-1.73	0.47	0.00	0.01	0.02	0.01	0.11	0.25
1450	-1.79	0.47	0.00	0.01	0.01	0.00	0.09	0.18
1750	-1.92	0.47	0.00	0.01	0.02	-0.01	0.07	0.04
1900	-1.98	0.48	0.00	0.01	0.02	-0.02	0.05	-0.01
2200	-2.11	0.47	0.00	0.01	0.03	-0.03	0.03	0.58
2350	-2.18	0.47	0.00	0.01	0.03	-0.03	0.01	0.27
2650	-2.29	0.46	-0.01	0.00	0.03	-0.06	-0.06	-1.40
2800	-2.32	0.46	-0.01	-0.01	0.02	-0.10	-0.12	-1.50
3100	-2.39	0.46	-0.03	-0.03	-0.01	-0.19	-0.28	0.17
3250	-2.41	0.46	-0.04	-0.05	-0.04	-0.26	-0.39	0.16
3550	-2.44	0.46	-0.06	-0.10	-0.11	-0.43	-0.64	-0.45
3700	-2.45	0.46	-0.07	-0.12	-0.15	-0.52	-0.72	-0.72
3900	-2.48	0.46	-0.08	-0.14	-0.19	-0.63	-0.85	-0.85
4000	-2.52	0.45	-0.08	-0.15	-0.20	-0.69	-0.95	-0.74

Freq. [MHz]	Return Loss In [dB]								Return Loss Out [dB]							
	@ Attenuation setting [dB]								@ Attenuation setting [dB]							
	0	0.5	1	2	4	8	16	31	0	0.5	1	2	4	8	16	31
0.1	-18.79	-20.34	-21.87	-19.97	-21.00	-24.11	-43.54	-42.52	-18.63	-19.24	-19.43	-24.48	-28.24	-32.18	-28.59	-47.11
1	-18.66	-20.23	-21.75	-19.81	-20.79	-23.77	-41.88	-42.64	-18.51	-19.13	-19.30	-24.34	-27.99	-31.68	-28.14	-47.23
10	-18.54	-20.10	-21.62	-19.72	-20.73	-23.73	-41.56	-42.89	-18.39	-19.02	-19.21	-24.20	-27.86	-31.61	-28.16	-47.70
100	-18.57	-20.12	-21.63	-19.74	-20.74	-23.72	-40.92	-43.49	-18.52	-19.15	-19.33	-24.35	-28.02	-31.76	-28.24	-47.09
200	-18.59	-20.15	-21.66	-19.77	-20.78	-23.77	-40.26	-43.48	-18.49	-19.12	-19.30	-24.30	-27.94	-31.64	-28.17	-47.13
400	-18.58	-20.12	-21.61	-19.73	-20.70	-23.60	-37.38	-42.97	-18.42	-19.03	-19.22	-24.10	-27.58	-30.96	-27.69	-45.60
500	-18.59	-20.12	-21.60	-19.72	-20.68	-23.53	-36.24	-40.56	-18.53	-19.14	-19.32	-24.22	-27.69	-30.98	-27.66	-56.03
700	-18.54	-20.05	-21.51	-19.64	-20.58	-23.35	-34.55	-35.20	-18.51	-19.11	-19.28	-24.10	-27.46	-30.44	-27.27	-60.30
800	-18.53	-20.03	-21.49	-19.63	-20.56	-23.28	-33.81	-33.08	-18.50	-19.10	-19.27	-24.06	-27.37	-30.24	-27.11	-47.75
1000	-18.60	-20.08	-21.51	-19.63	-20.49	-23.06	-31.95	-29.43	-18.49	-19.07	-19.23	-23.92	-27.04	-29.56	-26.56	-36.47
1100	-18.45	-19.92	-21.32	-19.48	-20.32	-22.83	-31.20	-28.47	-18.47	-19.06	-19.21	-23.87	-26.96	-29.35	-26.39	-32.95
1300	-18.21	-19.58	-20.87	-19.05	-19.74	-21.82	-27.94	-26.73	-18.43	-18.96	-19.05	-23.40	-25.97	-27.52	-24.83	-27.66
1450	-18.16	-19.44	-20.63	-18.72	-19.19	-20.87	-25.73	-25.69	-18.39	-18.82	-18.82	-22.80	-24.76	-25.59	-23.12	-24.81
1750	-18.02	-19.10	-20.04	-17.94	-18.07	-19.27	-23.06	-24.07	-18.59	-18.74	-18.53	-21.92	-22.78	-23.15	-21.20	-20.44
1900	-18.03	-18.96	-19.75	-17.70	-17.77	-19.05	-23.03	-22.99	-18.33	-18.34	-18.09	-21.00	-21.52	-22.19	-20.81	-18.71
2200	-16.33	-16.85	-17.27	-16.23	-16.59	-18.37	-22.81	-18.70	-17.11	-16.99	-16.87	-18.66	-19.11	-21.03	-21.57	-16.09
2350	-15.74	-16.13	-16.45	-15.95	-16.61	-18.97	-24.23	-15.92	-16.08	-16.01	-16.02	-17.33	-17.92	-20.53	-22.69	-15.21
2650	-14.58	-14.86	-15.07	-15.20	-16.20	-19.23	-24.51	-13.28	-14.64	-14.69	-14.85	-15.74	-16.50	-19.69	-23.85	-14.42
2800	-14.41	-14.63	-14.78	-15.16	-16.30	-19.58	-24.24	-12.57	-14.20	-14.29	-14.49	-15.28	-16.08	-19.41	-24.03	-14.05
3100	-14.14	-14.30	-14.36	-15.11	-16.45	-19.79	-22.16	-11.86	-13.82	-13.96	-14.21	-14.75	-15.51	-18.80	-22.90	-13.11
3250	-14.11	-14.22	-14.22	-15.13	-16.46	-19.38	-20.38	-11.72	-13.91	-14.08	-14.34	-14.75	-15.46	-18.62	-21.91	-12.74
3550	-14.01	-13.95	-13.79	-14.86	-15.83	-17.18	-16.65	-11.20	-14.85	-15.02	-15.28	-15.26	-15.68	-18.10	-19.33	-12.36
3700	-13.95	-13.81	-13.59	-14.62	-15.33	-15.99	-15.19	-11.02	-15.81	-15.95	-16.20	-15.76	-15.94	-17.75	-18.06	-12.20
3900	-13.72	-13.53	-13.24	-14.13	-14.52	-14.60	-13.64	-10.74	-17.04	-17.14	-17.36	-16.18	-15.99	-16.83	-16.21	-12.10
4000	-13.77	-13.60	-13.30	-14.15	-14.51	-14.49	-13.43	-10.74	-17.39	-17.45	-17.64	-16.09	-15.76	-16.18	-15.31	-12.10



TYPICAL PERFORMANCE CURVES (AT 25°C)

Attenuation Accuracy relative to Insertion Loss vs. Frequency

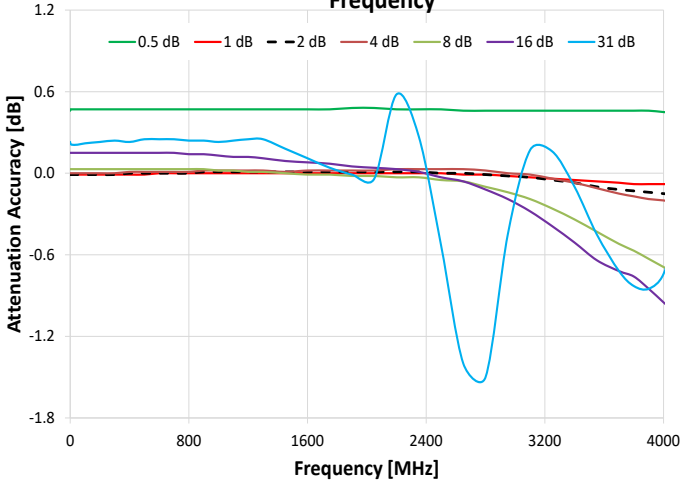

Attenuation relative to Insertion Loss vs. Frequency

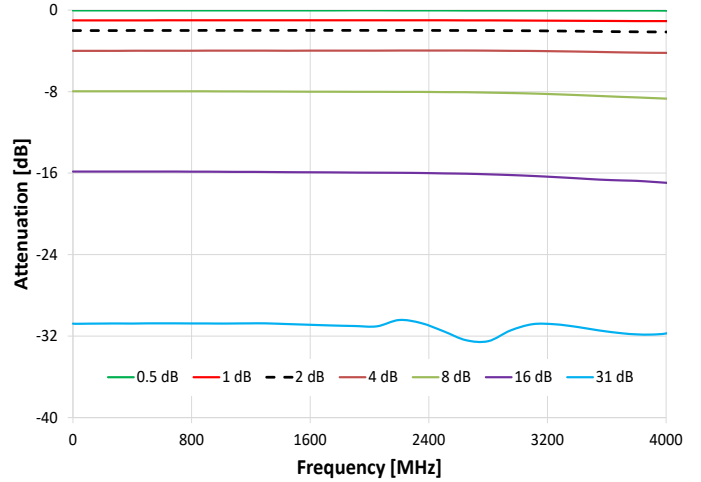

Insertion Loss vs. Frequency

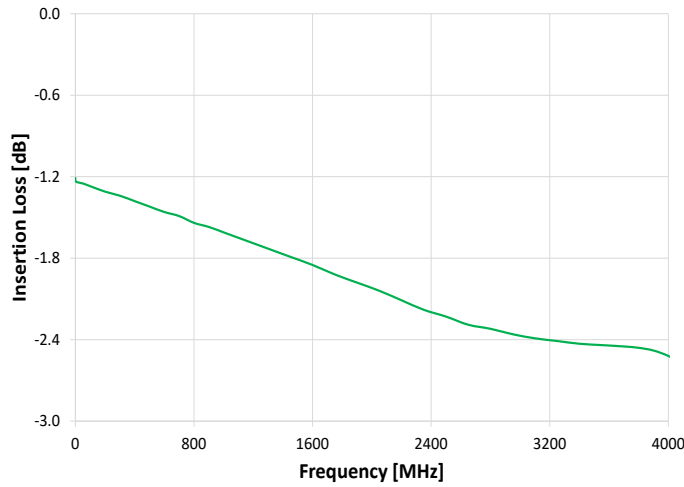

R. Loss In vs. Frequency over Attenuation settings

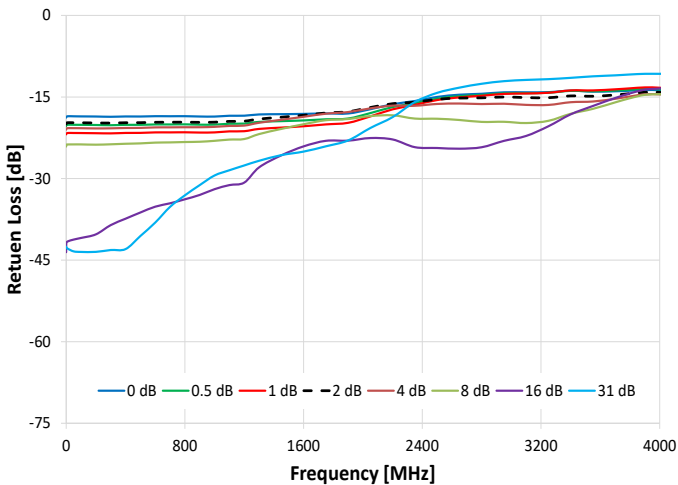

R. Loss Out vs. Frequency over Attenuation settings

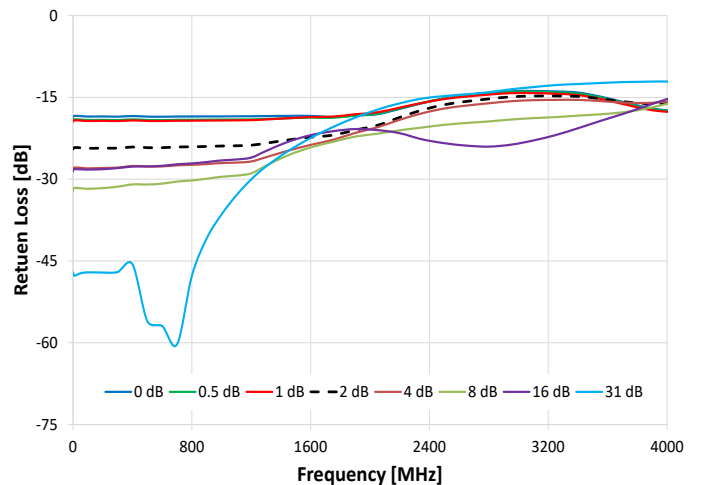



Digital Step Attenuator **ZX76-31A-PNS+**

ORDERING INFORMATION

Model	Description
ZX76-31A-PNS+	Digital attenuator - Parallel interface, Dual Voltage (Positive & Negative)

Recommended Accessories	Part No.	Description
	ZX76-WP+	4.9 ft. (1.5M) Control Cable

ADDITIONAL DETAILED TECHNICAL INFORMATION

Performance Data	Data Table
	Swept Graphs
	S-Parameter (S2P Files) Data Set (.zip.file)
Case Style	HK1149
Environmental Rating	ENV28T14

Additional information is available on our dash board. To access this information [click here](#)

- NOTES**
- A. Performance and quality attributes and conditions not expressly stated in this specification document are intended to be excluded and do not form a part of this specification document.
 - B. Electrical specifications and performance data contained in this specification document are based on Mini-Circuit's applicable established test performance criteria and measurement instructions.
 - C. The parts covered by this specification document are subject to Mini-Circuits standard limited warranty and terms and conditions (collectively, "Standard Terms"); Purchasers of this part are entitled to the rights and benefits contained therein. For a full statement of the standard. Terms and the exclusive rights and remedies thereunder, please visit Mini-Circuits' website at www.minicircuits.com/MCLStore/terms.jsp